

Article

Techno-Economic Analysis of Hybrid Diesel Generators and Renewable Energy for a Remote Island in the Indian Ocean Using HOMER Pro

T. M. I. Riayatsyah ^{1,*} , T. A. Geumpana ², I. M. Rizwanul Fattah ³  and T. M. Indra Mahlia ^{3,4,*} ¹ Mechanical Engineering Program, Institut Teknologi Sumatera (ITERA), South Lampung 35365, Indonesia² School of Information and Physical Sciences, University of Newcastle, Newcastle, NSW 2308, Australia³ School of Civil and Environmental Engineering, Faculty of Engineering and Information Technology, University of Technology Sydney, Sydney, NSW 2007, Australia⁴ Department of Mechanical Engineering, College of Engineering, Universiti Tenaga Nasional, Kajang 43000, Malaysia

* Correspondence: t.indra@ms.itera.ac.id (T.M.I.R.); tmindra.mahlia@uts.edu.au (T.M.I.M.); Tel.: +62-8525-4483-660 (T.M.I.R.); +61-416-646-288 (T.M.I.M.)

Abstract: This study is about the electrification of the remote islands in the Indian Ocean that were severely affected by the tsunami in the 2004 earth earthquake. To supply electricity to the islands, two diesel generators with capacities of 110 kW and 60 kW were installed in 2019. The feasibility of using renewable energy to supplement or replace the units in these two generators is investigated in this work. In 2019, two diesel generators with capacities of 110 kW and 60 kW were installed in the islands to supply electricity. This work analyses whether the viability of using renewable energy can be used to supplement or replace these two generators. Among the renewable energy options proposed here are a 100 kW wind turbine, solar PV, a converter, and batteries. As a result, the study's goal is to perform a techno-economic analysis and optimise the proposed hybrid diesel and renewable energy system for a remote island in the Indian Ocean. The Hybrid Optimisation Model for Electric Renewable (HOMER) Pro software was used for all simulations and optimisation for this analysis. The calculation is based on the current diesel price of USD 0.90 per litre (without subsidy). The study found that renewable alone can contribute to 29.2% of renewable energy fractions based on the most optimised systems. The Net Present Cost (NPC) decreased from USD 1.65 million to USD 1.39 million, and the levelised Cost of Energy (CoE) decreased from 0.292 USD/kWh to 0.246 USD/kWh, respectively. The optimised system's Internal Rate of Return (IRR) is 14% and Return on Investment (ROI) 10%, with a simple payback period of 6.7 years. This study shows that it would be technically feasible to introduce renewable energy on a remote island in Indonesia, where numerous islands have no access to electricity.

Keywords: techno-economic analysis; hybrid system; remote electrification; diesel-PV battery; remote island; HOMER



Citation: Riayatsyah, T.M.I.; Geumpana, T.A.; Fattah, I.M.R.; Mahlia, T.M.I. Techno-Economic Analysis of Hybrid Diesel Generators and Renewable Energy for a Remote Island in the Indian Ocean Using HOMER Pro. *Sustainability* **2022**, *14*, 9846. <https://doi.org/10.3390/su14169846>

Academic Editors: Mahyar Silakhori, Mohammad Hossein Doranehgard, Mohammad Reza Safaei and Reza Maihami

Received: 27 June 2022

Accepted: 6 August 2022

Published: 9 August 2022

Publisher's Note: MDPI stays neutral with regard to jurisdictional claims in published maps and institutional affiliations.



Copyright: © 2022 by the authors. Licensee MDPI, Basel, Switzerland. This article is an open access article distributed under the terms and conditions of the Creative Commons Attribution (CC BY) license (<https://creativecommons.org/licenses/by/4.0/>).

1. Introduction

It is no secret that the world has changed drastically since the industrial revolution, which resulted in massive emissions due to human activities. These operations have virtually reached the point of no return in exploring the earth's natural resources. The effect can be observed by extreme changes in the climate in many countries around the globe recently [1]. One of the activities contributing to climate change is energy generation, mainly conducted using fossil fuels such as coal and diesel [2]. This process generates a lot of greenhouse gasses, especially carbon dioxide, that contribute to global warming. If human activities still use this fossil fuel at the current rate, the world will be in catastrophe in a few decades [3]. Therefore, scientists and practitioners have suggested using alternative

sources of energy that are environmentally friendly to solve this problem. Some of the most popular ones involve harnessing renewable sources of energy such as hydropower, wind, and solar to power our daily activities [4–7].

Renewable energy has been explored intensively in developed countries such as the US, Australia, France, Germany, Italy, Spain, Turkey, and the UK to replace fossil fuel that harms the world environment, which is expected to be higher in the future [8–10]. However, renewable energy is not popular in developing countries such as Indonesia due to the cheap electricity price generated by fossil fuels [11]. The country's percentage electricity generation mix by source in 2020 is presented in Figure 1 [12]. Therefore, it needs encouragement to create the critical mass that renewable is reliable like fossil fuel power plants. Based on developed countries' experiences, renewable energy has been proven reliable, just like fossil power generation. There is also numerous new information that renewable energy sources today are cheaper than fossil fuel power generation in terms of levelised cost of energy (CoE).

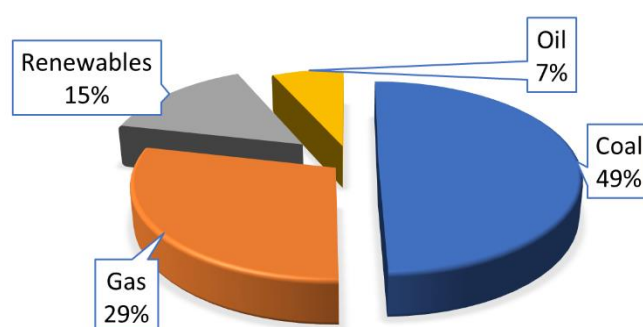

Figure 1. Percentage electricity generation mix by source in Indonesia in 2020.

According to the data presented in Figure 1, most of Indonesia's electricity comes from burning fossil fuels. Coal is responsible for nearly half of Indonesia's total electricity production. Because Indonesia is an archipelago and one of the countries that are most negatively impacted by global warming, the government of Indonesia is very eager to implement renewable energy throughout the country. The utilisation of renewable energy for electricity generation is only 15%, mainly from hydropower. The use of solar PV in Indonesia is still relatively underdeveloped, but it has tremendous potential, with a capacity of up to 207 GW and a utilisation rate of less than 1% [13]. Some existing studies on using renewable energy in Indonesia have been conducted in Biaro and Pemping island. These studies, such as the study on other optimum hybrid renewable energy systems in Biaro and Pemping island [14,15]. Both studies are about optimising the cost of electricity generation with hybrid power plants using HOMER. As renewable energy such as solar PV and wind energy becomes much cheaper now compared to a decade ago, this is the time for the government and the private sector to invest in renewable energy. Many countries, especially developed nations, have successfully transformed their electricity energy sources into renewable energy that developing countries can learn from their experiences. In some cases, renewable energy is much cheaper than fossil fuels, especially considering the energy security point of view. This is proven in European countries such as Germany, Denmark, Sweden, and Norway [16]. Therefore, this study aims to encourage the use of renewable energy in the country to replace coal, gas, and oil. The study's objective is to conduct a techno-economic analysis and optimise hybrid diesel and renewable energy systems for a remote island in the Indian Ocean using HOMER-Pro software. As a result, the novelty of this research lies in its focus on the optimisation of stand-alone hybrid diesel generators and the configurations of the renewable energy system for a remote island. The goal of this research is to enhance the accessibility, quality, and reliability of the renewable electricity supply using techno-economic analysis.

2. Methodology

The assessment of renewable energy projects usually requires the application of relevant criteria to on-site location data to appropriately examine the operational behaviour of all potential scenarios. In this research, the following analytical framework was used [17]:

- (a) Location specification.
- (b) The modelling data require:
 - (i) Average electric load demand;
 - (ii) Daily radiation and clearness index at the location;
 - (iii) The daily temperature at the location.
- (c) System architecture.

The data collected from the plant's location were visualised and examined using these criteria. Each was addressed and investigated to characterise the entire system design, emphasising the renewable energy component choices. HOMER Pro was created in 1992 by the US department of energy under National Renewable Energy Laboratory (NREL) as a more efficient way of modelling hybrid energy systems and analysing solutions for lowering electricity costs for a stand-alone renewable system. The HOMER Pro software has been used widely for techno-economic analysis of renewable energy simulation for off-grid renewable systems [18–21]. The HOMER Grid, on the other hand, was created to address a growing modelling difficulty that HOMER Pro cannot handle: reducing demand and time of use charges for Behind-The-Meter projects, from solar with storage to more complicated systems such as wind, backup generators, and combined heat and power [22–24]. It is a powerful tool that integrates engineering and economic data into a single model, allowing complicated calculations to be performed quickly to assess the value of self-consumption, optimisation, sensitivity analysis, and energy arbitrage. Users may analyse several components and design outputs, find cost-competitive points for alternative technologies, and examine strategies for reducing project risk and identifying the best cost-effective design. It also replicates real-world performance to help system designers and optimisers make better decisions. The methodology flowchart of the study is given in Figure 2.

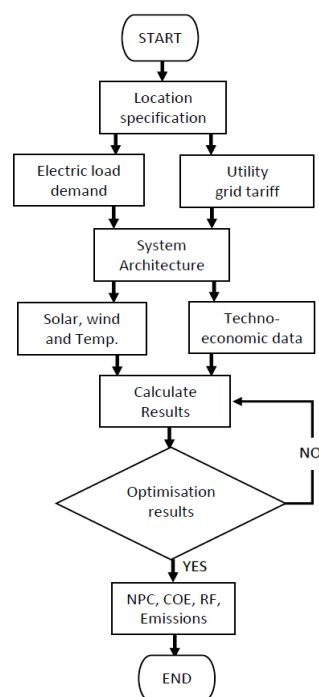

Figure 2. Methodology flowchart.

2.1. Location Specification

Indonesia is a Southeast Asian archipelago nation sandwiched between the Indian and Pacific Oceans. It is strategically located on or near critical maritime routes linking East Asia, South Asia, and Oceania. Indonesia is the world's biggest archipelago, stretching 5120 km east to west and 1760 km north to south and including 18,307 islands. There are still numerous islands without a stable electricity supply in Indonesia. One of them is Teupah Island in the Indian Ocean. Therefore, the facility selected for this study is 964W + VW Teupah Island, Simeulue Regency, Aceh, Indonesia ($2^{\circ}21.4' N$, $96^{\circ}14.8' E$), Aceh province, Indonesia. Currently, the electricity on the island is served by two generators (110 kW and 60 kW) that are already on the island. As part of these two generators, the study proposed to include renewable energy sources such as wind turbines, solar PV, and storage. Figure 3 shows the location of the facility's map view within the map of the Republic of Indonesia, and Figure 4 displays the topographic view map of the facility.



Figure 3. Location of the island on the globe and the map view of the facility [25].

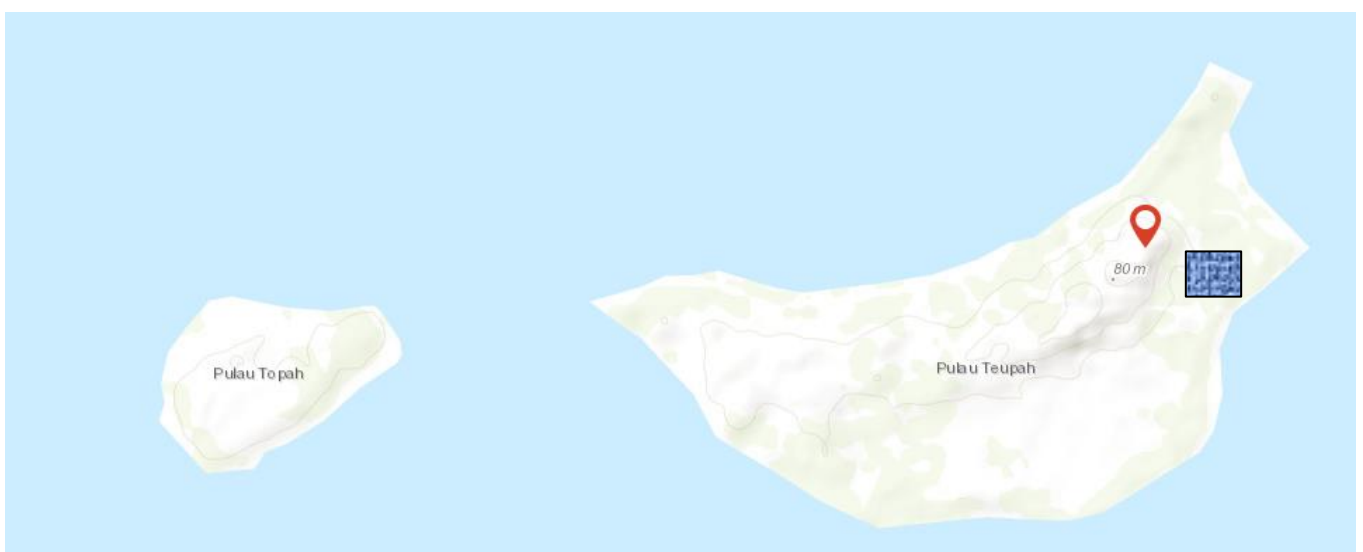

Figure 4. Topographic view map of the facility [25].

2.2. Modelling Data

2.2.1. Average Electric Load Demand

For this hybrid renewable energy system, some input data must be calculated to determine the optimised system with the best output and lowest cost, which will be shown in the figures and tabulated in the table in this section. Electric load demand is available on the island, which has 94 families and a population of 248 in 2019. This entire island consumes 1046.70 kWh per day, with an average peak load of 162.43 kW. Wet and dry seasons were represented by two sets of data used in January and July. Two sets of data usage for January and July represented wet and dry seasons. These data are used to predict the load demand of the system based on commercial HOMER Pro electric load. Due to its tropical climate, it is believed that the average electric load is not much different for the whole year, and the average electric load of the island is presented in Figure 5a,b.

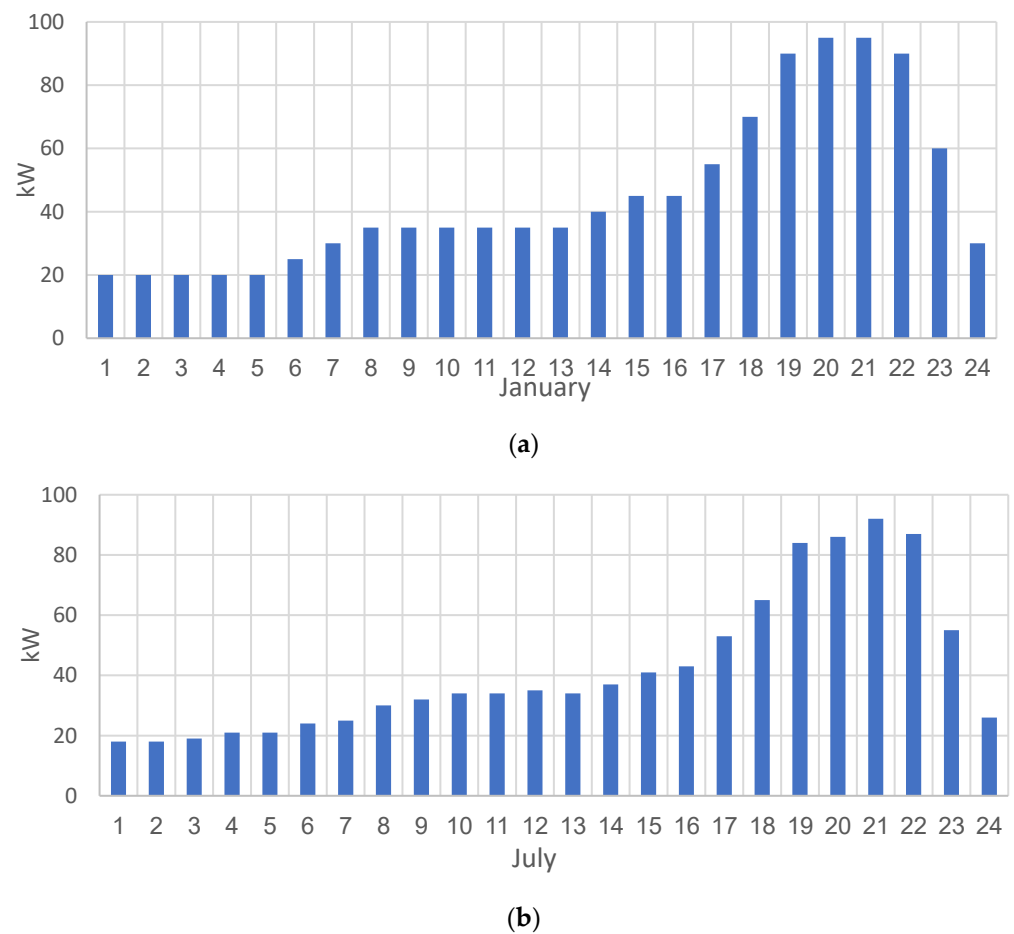

Figure 5. The predicted average electric load of the island in (a) January and (b) July.

2.2.2. Radiation, Clearness Index, Temperature, and Wind Speed

The daily radiation and clearness index statistics are indicators of the atmosphere's clarity. The percentage of solar energy passes through the atmosphere and reaches the Earth's surface. It is determined by dividing surface radiation by extraterrestrial radiation, yielding a one-dimensional value from 0 to 1. When the weather is clear and sunny, the clearness index has a high value, and when it is overcast, it has a low value [26]. Figure 6 depicts the solar daily radiation and clearness index at the selected location. Meanwhile, Figures 7 and 8 illustrate the daily temperature and the monthly average wind speed at the selected location, respectively.

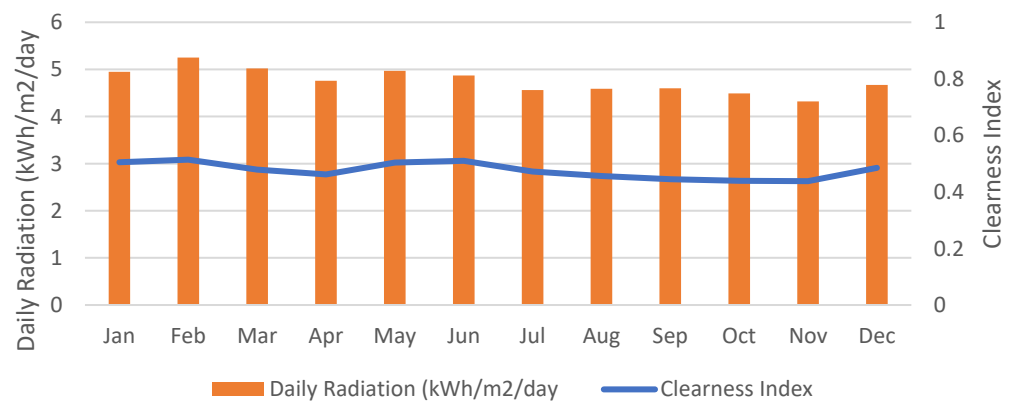

Figure 6. Solar daily radiation and clearness index at the location [27].

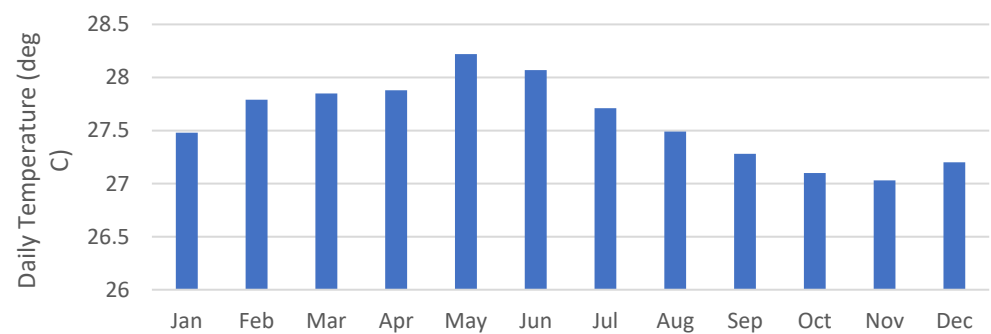

Figure 7. The daily temperature at the location [28].

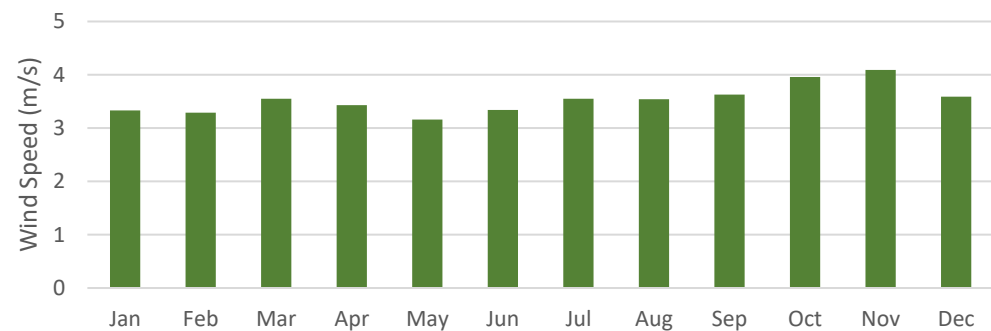

Figure 8. The monthly average wind speed at the location [28].

2.3. Proposed System Architecture

The system architecture must be designed first before simulating the renewable energy system. The system design, in this case, consists of lead batteries and a converter as the study's storage equipment, along with power sources from generators, PV, and wind turbines. The generator used that is already installed on the island are two diesel generators. The solar PV selected is the generic plat PV with ground reflectance of 20%, derating factor of 80%, and a lifetime of 25 years. The proposed wind turbine is at a rate of 100 kW, a hub height of 31.80 m, and 25 years of lifetime. The battery selected is the lead acid battery DC with a nominal voltage of 12 V, nominal capacity of 1 kWh, capacity ratio 0.403, roundtrip efficiency 80%, maximum state charge 100%, minimum state charge 40%, the throughput of 800 kWh and the lifetime of 10 years. Meanwhile, the system converter selected has a relative capacity of 100%, inverter and rectifier input efficiency of 95%, and a lifetime of 15 years. The equipment is collected from the catalogue provided by the software. Figure 9 depicts the schematic diagram of the proposed system architecture. The detailed information of the proposed system is tabulated in Table 1. In this scenario, solar PV, wind

turbines, and a battery energy storage system serve the load, and all systems are connected to the two generators grid.

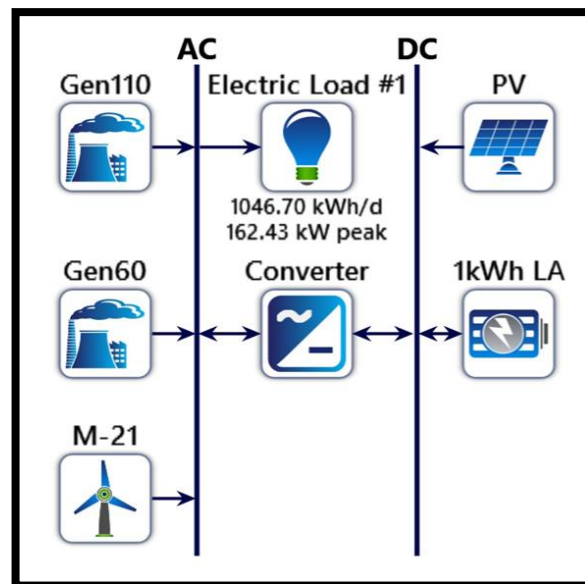

Figure 9. Proposed system architecture.

Table 1. The component of the proposed system architecture.

Component	Name	Capital Cost (USD)	Replacement	O&M Cost (USD)	Lifetime	Ref.
Generator #1	Gen 110 kW	0	11,300	0.025/op hour	20,000 h	[29]
Generator #2	Gen 60 kW	0	7600	0.020/op hour	20,000 h	[30]
PV	Flat plate PV	1073/kW	1073/kW	10/year	25 years	[31]
Storage	1 kWh Lead Acid	300/kW	300/kW	25/year	10 years	[25]
Wind turbine	XANTM21 [100 kW]	210,000	210,000	3500/year	25 years	[32]
Converter	System Converter	300/kW	300/kW	0	15 years	[25]

2.3.1. Photovoltaic

In a photovoltaic system, a debating factor that is a scaling factor applied to the PV array output and a debating factor of 90% for the component is added to account for the losses and those attributable to the PV panel soiling [33]. The PV array's energy output is determined using the formula below [26]:

$$P_{PV} = f_{PV} \times Y_{PV} \times \left(\frac{I_T}{I_S} \right) \quad (1)$$

where f_{PV} is the debating factor, Y_{PV} is the total installed capacity of the PV panel, I_T is the solar irradiation, and $I_S = 1 \text{ kW/m}^2$. The price of solar PV will decrease when the number of installed capacity increases; for this project, the price will decrease to 93%, 66%, and 54% for 10 kW, 1000 kW, and 2000 kW, respectively [34]. The solar PV price used in this system is tabulated in Table 2.

Table 2. The capacity and the price of generic flat panel solar PV [34].

Capacity (kW)	Capital (USD)	Replacement (USD)	O&M (USD/year)
5	5365	5365	100
10	9979	9979	180
1000	708,180	708,180	1500
2000	1,158,840	1,158,840	3000

2.3.2. Wind Turbine

HOMER models a wind turbine as a device that converts wind kinetic energy into AC or DC electricity via a power curve (a graph of power output against wind speed at hub height). HOMER estimates the wind turbine's electricity production every hour in a four-step procedure. First, it uses wind resource data to determine the average wind speed for the hour at the anemometer height. Second, it uses either the logarithmic or power laws to calculate the correlation of wind speed at the turbine's hub height. Third, it has to do with the turbine's power curve, which is used to calculate the turbine's power output based on traditional air density assumptions for a particular wind speed. Fourth is the air density ratio, which is the ratio of actual to standard air density multiplied by the total power output. To extrapolate wind speed data in HOMER, use the power-law formula below [26]:

$$U_{hub} = U_{anem} \left(\frac{Z_{hub}}{Z_{anem}} \right)^{\alpha} \quad (2)$$

where U_{hub} is the wind speed at the wind turbine hub height (m/s), U_{anem} is the wind speed at anemometer height (m/s), Z_{hub} is the wind turbine hub height (m), Z_{anem} is the anemometer height (m), and α is the power-law exponent. When corrected for density, power curves generally describe wind turbine performance under standard temperature and pressure conditions (STP). HOMER adjusts to real-world circumstances by multiplying the air density ratio by the power value estimated by the power curve with the air density at standard temperature and pressure (1.225 kg/m³), as follows [26]:

$$P_{WTG} = \left(\frac{\rho}{\rho_0} \right) \times P_{WTG,STP} \quad (3)$$

where P_{WTG} is the wind turbine power output (kW), $P_{WTG,STP}$ is the wind turbine power output at standard temperature and pressure (kW), ρ is the actual air density (kg/m³), and ρ_0 is the air density at standard temperature and pressure (1.225 kg/m³).

2.3.3. Battery

HOMER models a single battery as a device capable of storing a specific amount of DC power with fixed energy efficiency, subject to limits on how quickly it can be charged or drained, as well as how much energy can cycle through it before it needs to be replaced. The programme implies that the battery's characteristics stay consistent over time and are unaffected by environmental influences such as temperature. A group of one or more separate batteries is referred to as a battery bank. The software predicted the life of the battery bank just by monitoring the amount of energy cycling through it since the lifetime throughput is independent of cycle depth in this situation. The battery bank's life in years is calculated by the programme based on the following equation [26]:

$$R_{batt} = \text{MIN} \left(\frac{N_{batt} \times Q_{lifetime}}{Q_{thrpt}}, R_{batt,f} \right) \quad (4)$$

where R_{batt} is the life of storage bank (year), N_{batt} storage bank number of batteries, $Q_{lifetime}$ is the single storage lifetime throughput (kWh), Q_{thrpt} is storage throughput annually (kWh/year), and $R_{batt,f}$ is storage float life (year).

The expense of cyclic energy through the storage bank is known as the battery wear cost. Suppose the storage characteristics show that throughput is a constraint on storage life. In that case, the programme estimates that the storage bank will need to be replaced when its total throughput equals its lifetime throughput. As a result, the storage bank approaches its necessary replacement with each kWh of throughput. The software uses the following calculation to compute the cost of storage wear [26]:

$$C_{bw} = \frac{C_{rep,batt}}{N_{batt} \times Q_{lifetime} \times \sqrt{\eta_{rt}}} \quad (5)$$

where $C_{rep,batt}$ is storage bank replacement cost (USD), N_{batt} is storage bank number of batteries, $Q_{lifetime}$ is single storage lifetime throughput (kWh), and η_{rt} is storage roundtrip efficiency (fractional). The price of a Generic 1 kWh Lead Acid battery will decrease with the increasing number of installed capacity; for this project, the price will drop to 73%, 61%, 57%, and 54% for 200 kWh, 2000 kWh, 8000 kWh, and 16,000 kWh, respectively [34]. The capacity and the price of the Generic 1 kWh Lead Acid are tabulated in Table 3.

Table 3. The capacity and the price of generic 1 kWh Lead Acid batteries [34].

Capacity (kWh)	Capital (USD)	Replacement (USD)	O&M (USD/year)
5	1500	1500	0
10	3000	3000	0
200	47,400	47,400	1800
2000	366,000	366,000	16,000
8000	1,368,000	1,368,000	64,000
16,000	2,592,000	2,592,000	112,000

2.3.4. Converter

A converter is a device that converts electric power from DC to AC during inversion and from AC to DC during rectification. The converter size refers to the inverter capacity or the most significant amount of AC power the device can generate by inverting DC energy. The rectifier capacity is expressed as a percentage of the inverter capacity, which is the highest amount of DC power the device can produce by rectifying AC power. The inverter and rectifier capabilities are continuous, not surged, and the appliance can manage the load for as long as required, according to the software. The inverter must be able to synchronise with the AC frequency to achieve this, which some inverters lack. The inversion and rectification efficiencies of the converter are the ultimate physical attributes of the converter, which expects to remain constant by the software. The converter's economic features are the capital and replacement costs in dollars per year and the converter's projected lifespan in years.

2.4. Economic Analysis

For the purpose of computing the techno-economic analysis of this engineering renewable energy system, some economic data are required. The nominal discount rate, the expected inflation rate, and the projected lifetime of the project are some of the data that are included here. The economic data required for this analysis are tabulated in Table 4.

Table 4. Economic input data.

Description	Value	Unit	References
Currency	USD 1	Rp 14,000	[35]
Diesel Price	USD 0.9/L	Rp 12,500	[36]
Nominal discount rate	6.6	%	[37]
Expected inflation rate	2.0	%	[38]
Project lifetime	25	year	[39]

2.4.1. Interest Rate

One of the pieces of information that are taken into consideration by this programme is the annual real interest rate, which is also referred to as the real interest rate or simply interest rate. To convert one-time costs into annualised expenses, the discount rate is utilised. The following equation is what is used to determine how the annual real interest rate relates to the annual nominal interest rate [26]:

$$i = \frac{i' - f}{1 + f} \quad (6)$$

The real interest rate is i the nominal interest rate is i_0 (the rate at which the project may acquire a loan), and the yearly inflation rate is f in this equation.

2.4.2. Levelised Cost of Energy

The software defines the average cost per kWh of usable electrical energy generated by the system as the Levelised Cost of Energy (CoE). The programme divides the yearly cost of generating electricity (total annualised cost minus the cost of feeding the thermal load) by the total useable electrical energy output to determine the CoE . The CoE is calculated by the following equation [26]:

$$CoE = \frac{C_{ann,tot}}{E_{prim,AC} + E_{prim,DC} + E_{grid,sales}} \quad (7)$$

In this equation, $C_{ann,tot}$ is the total annualised cost (USD/year), $E_{prim,AC}$ is AC primary load served (kWh/year), $E_{prim,DC}$ is DC primary load served (kWh/year), and $E_{grid,sales}$ is total grid sales (kWh/year). The total annualised cost is the sum of each system component's annualised costs and the other.

2.4.3. Net Present Cost (NPC)

The total net present cost (NPC) is equal to the present value of all expenditures incurred over the system's lifespan minus the present value of all income earned over the system's lifetime. Capital expenses, replacement costs, operations and maintenance costs, fuel costs, pollution fines, and the cost of obtaining electricity from the grid are all included. Salvage value and grid sales income are two sources of revenue. The total NPC is calculated by adding the total discounted cash flows in each year of the project's lifecycle and calculated as follows [26]:

$$C_{NPC} = \frac{C_{ann,tot}}{CRF(i, R_{proj})} \quad (8)$$

In this equation $C_{ann,tot}$ is the total annualised cost (USD/year), CRF is the capital recovery factor, i is the real interest rate (%), and R_{proj} is project lifetime (year) (25 years in this study). The capital recovery factor is a ratio used to assess an annual present value (a series of equal annual cash flows). The capital recovery factor's equation is [26]:

$$CRF(i, N) = \frac{i(1+i)^N}{(1+i)^N - 1} \quad (9)$$

where i is the real interest rate (%) and N is the number of years.

2.4.4. Salvage Value

The worth of a component of the power system that is still usable at the end of the project's lifespan is referred to as salvage value. The software uses this equation to figure out how much each component is worth after the project's life cycle [26]:

$$S = C_{rep} \frac{R_{rem}}{R_{comp}} \quad (10)$$

where S is the salvage value, C_{rep} is the component replacement cost, R_{rem} is the remaining component life, and R_{comp} is the component lifetime.

2.4.5. Internal Rate of Return (IRR)

The internal rate of return is the discount rate at which the base case and optimised system have the exact net present cost (IRR). The programme calculates the IRR by dividing the present value of the difference between the two cash flow sequences by the discount rate.

2.4.6. Return on Investment (ROI)

The annual cost savings compared to the original expenditure is known as the return on investment (ROI). The ROI is calculated by dividing the difference in capital cost by the average annual difference in nominal cash flows during the project's lifespan. The return on investment is calculated by using the following equation [26]:

$$ROI = \frac{\sum_{i=0}^{R_{proj}} C_{i,ref} - C_i}{R_{proj} (C_{cap} - C_{cap,ref})} \quad (11)$$

where $C_{i,ref}$ is nominal annual cash flow for the base (reference) system, C_i is nominal annual cash flow for the current system, R_{proj} is project lifetime in years, C_{cap} is the capital cost of the current system, $C_{cap,ref}$ is the capital cost of the base (reference) system.

2.4.7. Simple Payback

The length of years it takes for the cumulative cash flow of the difference between the optimised and reference case systems to transition from negative to positive is known as simple payback. The payback period is the time it takes to recover the investment cost difference between the optimised and base case systems.

2.4.8. Total Annualised Cost

The total annualised cost of a component is the cost that, if distributed evenly throughout the project's lifespan, would result in the same net present cost as the component's actual cash flow sequence. The annualised cost is calculated by multiplying the net present cost by the capital recovery factor, as shown in the following equation [26]:

$$C_{ann, tot} = CRF(i, R_{proj}) \times C_{NPC, tot} \quad (12)$$

where $C_{NPC, tot}$ is the total net present cost (USD), i is the annual real discount rate (%), R_{proj} is the project lifetime (year), and CRF is a function returning the capital recovery factor. The levelised cost of energy is calculated using the entire annualised cost.

3. Result and Discussions

HOMER Pro simulates the technical and economic feasibility of microgrid or distributed energy systems that are off-grid or connected to an unreliable grid, allowing it to model and optimise low-cost renewable energy systems and risk-mitigation techniques. The programme demonstrates how to combine conventional energy generation with renewable energy, storage, grid resources (if available), and load control based on techno-economic analysis. In a single data run, the programme evaluates and optimises the electrical system architecture, load profiles, components, fuel prices, and environmental factors, simulating the operation of a hybrid microgrid or distributed energy system for an entire year. The simulation provides critical information about the technical performance of a system, risk avoidance, and potential cost savings. This section summarises the investi-

gation findings, with the optimisation results appearing first, followed by the economic evaluation results.

3.1. Optimisation Results

The optimisation results for the plant location at 964W + VW Teupah Island, Simeulue Regency, Aceh province, Indonesia (2°21.4' N, 96°14.8' E) reveal eight best probabilities. This microgrid uses 1047 kWh per day and has a peak power of 162 kW. The simulation process produced a list of system configurations and their capacities, which were chosen based on the lowest *CoE* and the *NPC*; the programme evaluates the cost and determines the viability of hybridised energy systems over the lifetime of the project time. Different configurations are created based on simulation input data, with the reference case system shown in light blue. This research selects the optimal system design best suits the island configuration system. The optimised component detail is presented in Table 5 (the reference case is in light blue), and the most optimised system is shown in Figure 10. The optimised components system detail is tabulated in Table 6.

Table 5. Optimisation results of the proposed system.

Rank	PV (kW)	M-21	Gen110 (kW)	Gen60 (kW)	1 M kWh LA	Converter (kW)	NPC (USD)	CoE (USD)	Ren Frac (%)
1	274		110	60	76	64.6	1,393,022	0.246	29.2
2	261		110	60		59.2	1,477,688	0.261	20.6
3	257	1	110	60	84	61.5	1,550,089	0.274	36.5
4			110	60			1,654,675	0.292	0.0
5			110	60	2	1.3	1,656,018	0.293	0.0
6	254	1	110	60		57.4	1,674,896	0.296	24.8
7		1	110	60			1,813,790	0.320	2.40
8		2	110	60	64	16.5	1,943,753	0.343	13.0

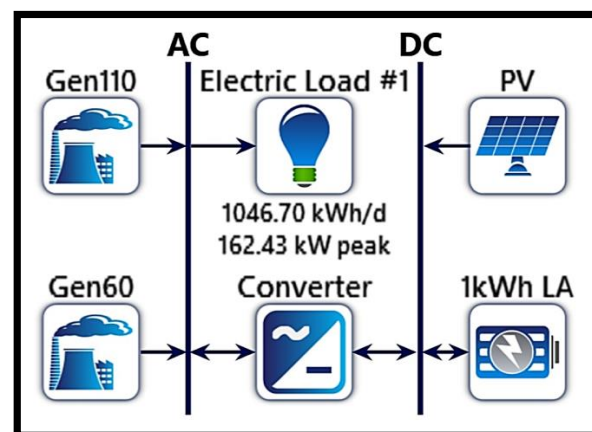

Figure 10. The optimised system architecture.

Table 6. Optimised components detail.

Component	Name	Size
Generator #1	Diesel Genset	110 kW
Generator #2	Diesel Genset	60 kW
PV	Generic flat-plate PV	274 kW
Converter	System Converter	65 kW
Storage	Generic 1 kWh Lead Acid	76 kWh

3.2. Electricity Generation

The optimised system that consists of 274 kW generic flat-plate PV, 65 kW system converter, and 76 kWh generic 1 kWh lead-acid has produced 29.2% renewable energy fraction. The electricity generated using solar PV, Genset 110 kW, and 60 kW are 295,535 kWh/year, 268,060 kWh/year, and 2480 kWh/year, respectively. The electricity consumption is 381,958 kWh/year from the total electricity generation of 566,075 kWh/year. The summary of the monthly electricity generation to supply 1047 kWh/day with the peak load of 162 kW by this optimised system is presented in Figure 11, and the power output of Genset 110 kW, Genset 60 kW, and solar PV output, as well as the charge percentage of lead-acid batteries illustrated in Figure 12. From these figures, it can be seen that the larger Genset 110 kW is used more frequently (5560 h/year) than the smaller Genset 60 kW, which is only used occasionally (122 h/year) between 6 p.m. and 12 a.m. as an additional power supply for the larger one when the demand exceeded its maximum capacity. The PV, on the other hand, operates for a maximum of 4405 h per year while producing a maximum output of 261 kW from its 274 kW rated capacity. In the meantime, the 76 batteries are mostly fully charged from 11 a.m. to 12 a.m. every day of the year, producing 12,370 kWh of energy each year, to consume only 9896 kWh energy per year, generating an energy loss of 2474 kWh annually, and the annual throughput of 11,064 kWh.

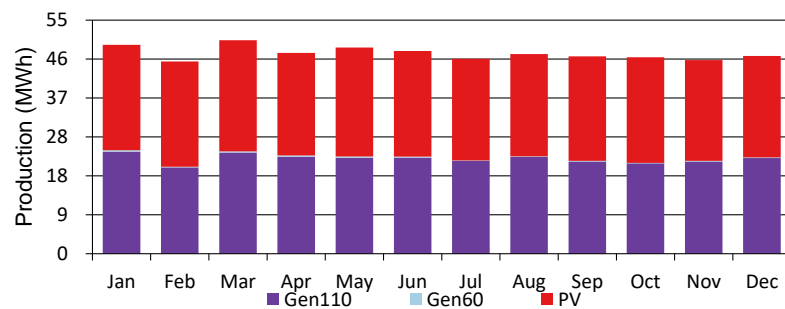

Figure 11. The electricity generation of the optimised system.

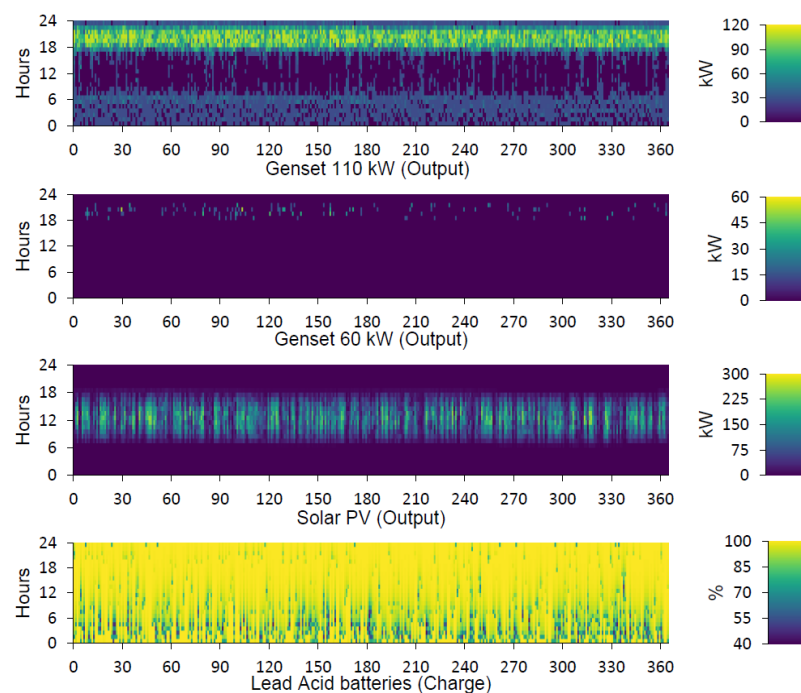

Figure 12. From the top are Genset 110 kW, Genset 60 kW, Solar PV output, and percentage of Lead-Acid batteries Charge.

3.3. Economic Evaluation Results

The findings revealed that the proposed optimised system had the best economic features throughout the project lifetime, unlike the reference scenario, which relies on two generators. Wind energy does not appear in the optimisation results due to the low wind speed and high investment cost, whereas the best is the combination of the system architecture, which consists of PV, generator Gen110/Gen60, and batteries with the Total Net Present Cost of USD 1.39 Million and the levelised cost of energy of 0.246 USD/kWh compared to 1.65 Million and 0.292 USD/kWh of the reference system, respectively. The cost summary of the project components is presented in Figure 13, which shows that most of the cost is the resource cost for generators fuel, followed by capital cost, replacement cost, operating cost, and salvage costs. At the same time, the economic and component chronological cash flow of the 25 years of the project lifetime is given in Figure 14. From these figures, it can be seen that the majority of the expenditure went towards the fuel that was used for both generators, whereas for renewable energy, most of the investment went towards the purchase of the solar PV, followed by Generic Lead Acid batteries and system maintenance expenses, which came to USD 203,687, USD 66,622, and USD 58,109, respectively.

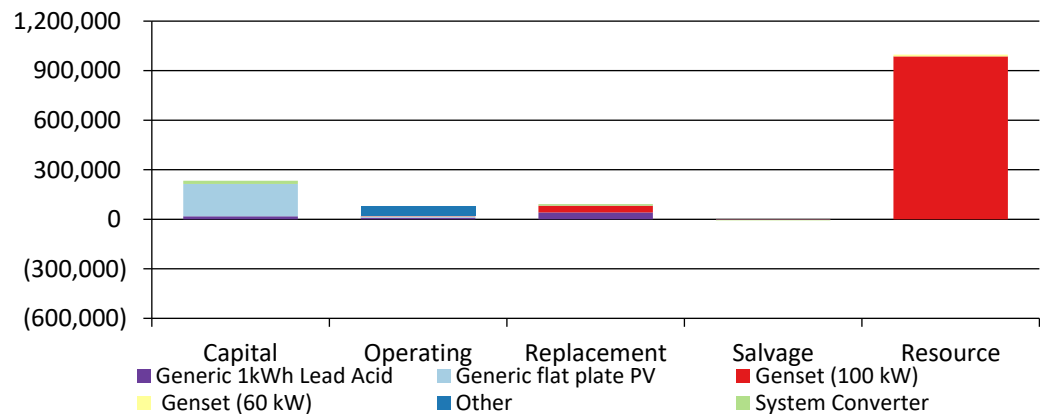

Figure 13. The cost summary of the project components.

The optimised hybrid system proposes would reduce the annual operational expenditure, fuel consumption, and CO₂ emission from USD 111,702, 112,335 L/year and 294,550 kg/year to USD 78,268, 74,801 L/year and 196,140 kg/year, respectively. This investment has a simple payback period of 6.7 years and an IRR of 14%. In this scenario, the emissions are typically carbon dioxide, sulphur dioxide, and nitrogen oxides. These are the most common types of emissions produced by generators that use fossil fuels. However, the only emission factor taken into account in this study was carbon dioxide. Table 7 provides a comprehensive presentation of the results of the economic metrics. The economic comparison between the base and optimised systems with their carbon dioxide emissions is tabulated in Table 8. The cumulative cash flows of simple payback throughout the lifetime, which is 25 years, are presented in Figure 15.

Table 7. Economic metrics of the optimised system.

Descriptions	Value
Internal Rate of Return	14%
Return on Investment	10%
Simple payback	6.7 year
Discounted payback	8.4 year
Capital Investment	USD 233,619
Annualised Savings	33,434 USD/year
Net Present Value	USD 261,653

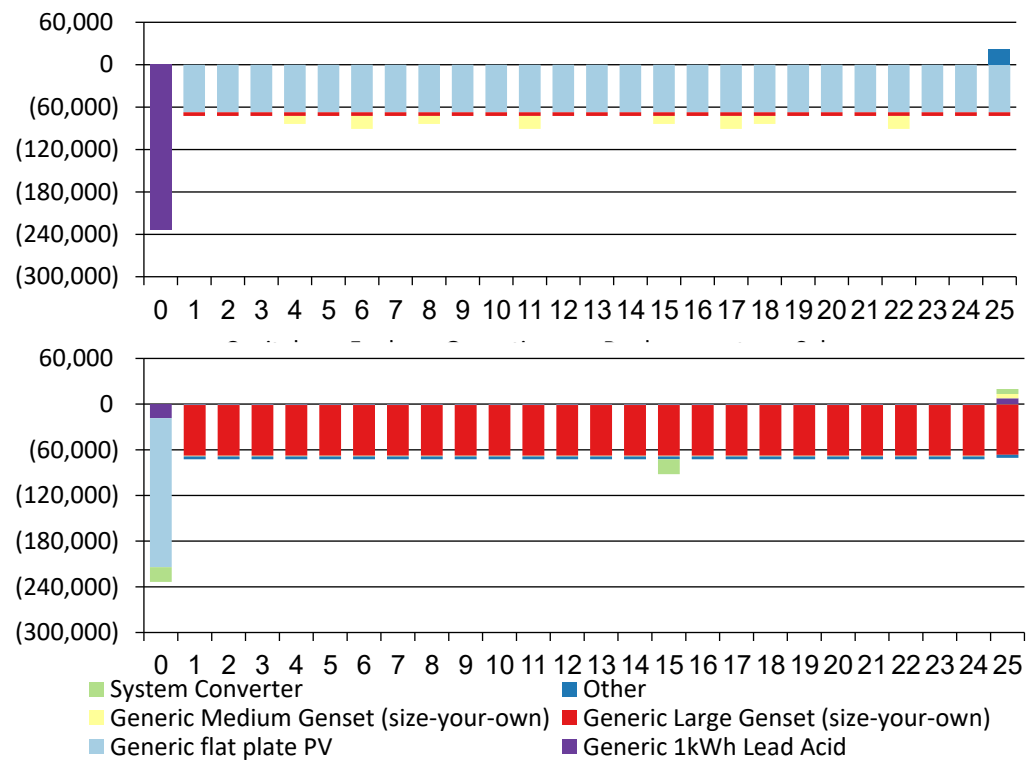

Figure 14. The economic and component chronological cash flow.

Table 8. The economic comparison between the base and the optimised system.

Description	Base System	Optimised System
Net Present Cost	USD 1.65 M	USD 1.39 M
CAPEX	USD 0.00	USD 233,619
OPEX	USD 111,702	USD 78,268
LCoE	0.292 USD/kWh	0.246 USD/kWh
CO ₂ Emitted	294,550 kg/year	196,140 kg/year

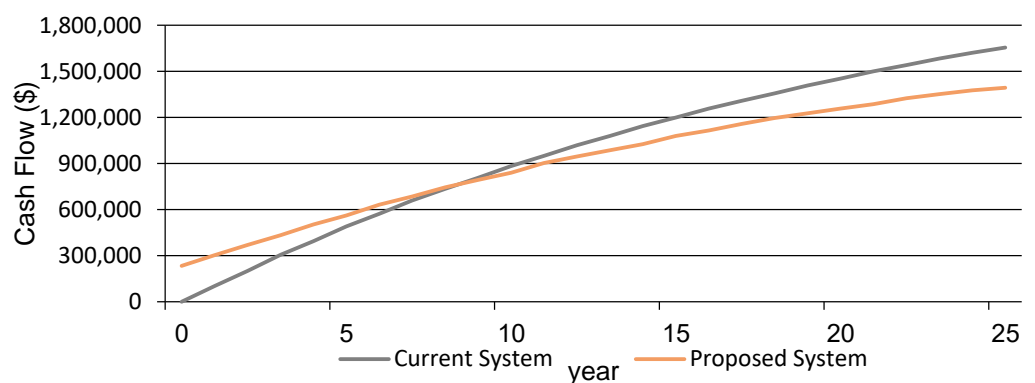

Figure 15. Simple payback of cumulative cash flow over the project lifetime.

Based on the results in Tables 7 and 8 and Figure 15, it is confirmed that with a little investment, the project can create long-term benefit to society with a payback period of fewer than 7 years for 25 years of the project lifetime. However, with the improvement of technology and material, there is a possibility the life span of solar PV will be longer than 25 years. As a result, using solar photovoltaic modules with a lifespan up to 40–50 years may help us predict how the economic calculations may change in the future. At the same time, other types of solar PV technology are also available. For instance, solar PV thermal

modules come in various designs, some of which allow to receive thermal energy. They also positively impact economic calculations, including the reduction in payback. The thermal energy can be used by consumers, and the excess heat removed will boost the solar installation's electrical efficiency and power production.

4. Conclusions

This study is about implementing renewable energy sources on a remote island in the Indian Ocean, near Aceh province Indonesia. The study found that with the current diesel price without subsidy, it is possible to implement a renewable energy system on the island hybridised with the diesel generator that has already been installed on the island. However, because this is one of the country's most remote islands, the high investment cost necessitated government intervention early on. The recommendation is to use renewable energy, in this case, solar PV and batteries, as support for traditional generators. The study found that, out of the eight optimisation outcomes listed in Table 5, four of them—those ranked 3, 6, 7, and 8—suggested using a wind turbine, while the least expensive was placed third among those ranked based on *NPC*. This is because of two factors. The first is that the average wind speed on the island is relatively low, which prevents the turbine from producing adequate electricity. The second is that, in contrast to solar PV, wind turbines cost two to three times more per kW of electricity produced. However, the system architecture with a wind turbine is the one that contributes to the highest fraction of renewable energy. Finally, this study is one of the attempts to introduce renewable energy on a remote island in the country where numerous islands have no access to electricity. Hopefully, with this, the authority will prioritise renewable energy in the country with abundant coals used as the primary energy source for electricity generation.

Author Contributions: T.M.I.R.: Writing—original draft, Formal analysis, Investigation, and Visualisation. T.A.G.: Data curation and Validation. I.M.R.F.: Conceptualisation, Methodology, and Resources. T.M.I.M.: Supervision and Writing—reviewing and editing. All authors have read and agreed to the published version of the manuscript.

Funding: This research was supported by Institut Teknologi Sumatera under a research grant for Hibah Publikasi GBU-45 and Pendidikan Tinggi Republik Indonesia. This research was also funded by the Universiti Tenaga Nasional grant no. IC6-BOLDREFRESH2025 (HCR) under the BOLD2025 Program.

Institutional Review Board Statement: Not applicable.

Informed Consent Statement: Not applicable.

Data Availability Statement: Not applicable.

Acknowledgments: The authors wish to acknowledgement Institut Teknologi Sumatera supports the research under Research Grant for Hibah Publikasi GBU-45 and Pendidikan Tinggi Republik Indonesia. This research is also funded by the Universiti Tenaga Nasional grant no. IC6-BOLDREFRESH2025 (HCR) under the BOLD2025 Program.

Conflicts of Interest: The authors declare no conflict of interest.

References

1. Ma, W.W.; Rasul, M.G.; Liu, G.; Li, M.; Tan, X.H. Climate change impacts on techno-economic performance of roof PV solar system in Australia. *Renew. Energy* **2016**, *88*, 430–438. [[CrossRef](#)]
2. Norouzi, N. The Pahlev Reliability Index: A measurement for the resilience of power generation technologies versus climate change. *Nucl. Eng. Technol.* **2021**, *53*, 1658–1663. [[CrossRef](#)]
3. Johnson, L. Geographies of Securitized Catastrophe Risk and the Implications of Climate Change. *Econ. Geogr.* **2014**, *90*, 155–185. [[CrossRef](#)]
4. Gonzalez-Salazar, M.; Pogonietz, W.R. Evaluating the complementarity of solar, wind and hydropower to mitigate the impact of El Nino Southern Oscillation in Latin America. *Renew. Energy* **2021**, *174*, 453–467. [[CrossRef](#)]

5. Graabak, I.; Korpas, M. Balancing of variable wind and solar production in Continental Europe with Nordic hydropower—A review of simulation studies. In Proceedings of the 5th International Workshop on Hydro Scheduling in Competitive Electricity Markets, Trondheim, Norway, 17–18 September 2015; pp. 91–99.
6. Yao, Y.; Xu, J.H.; Sun, D.Q. Untangling global levelised cost of electricity based on multi-factor learning curve for renewable energy: Wind, solar, geothermal, hydropower and bioenergy. *J. Clean. Prod.* **2021**, *285*, 124827. [CrossRef]
7. Norouzi, N.; Bozorgian, A.; Dehghani, M.A. Best Option of Investment in Renewable Energy: A Multicriteria Decision-Making Analysis for Iranian Energy Industry. *J. Environ. Assess. Policy Manag.* **2020**, *22*, 2250001. [CrossRef]
8. Rahman, M.; Alam, K. Impact of industrialization and non-renewable energy on environmental pollution in Australia: Do renewable energy and financial development play a mitigating role? *Renew. Energy* **2022**, *195*, 203–213. [CrossRef]
9. Sahin, U. Future of renewable energy consumption in France, Germany, Italy, Spain, Turkey and UK by 2030 using optimized fractional nonlinear grey Bernoulli model. *Sustain. Prod. Consum.* **2021**, *25*, 1–14. [CrossRef] [PubMed]
10. Dabboussi, M.; Abid, M. A comparative study of sectoral renewable energy consumption and GDP in the US: Evidence from a threshold approach. *Renew. Energy* **2022**, *192*, 705–715. [CrossRef]
11. Burke, P.J.; Kurniawati, S. Electricity subsidy reform in Indonesia: Demand-side effects on electricity use. *Energy Policy* **2018**, *116*, 410–421. [CrossRef]
12. Satista. *Energy Mix for Power Generation in Indonesia as of May 2020, by Source*; Satista: Hamburg, Germany, 2021.
13. IESR. *Indonesia Solar Potential Report*; IESR: Nairobi, Kenya, 2021.
14. Aisyah, S.; Aditya, I.A.; Syamsudin, A. Optimum Hybrid Renewable Energy System Design Using Homer: Case Study Biaro Island, Indonesia. In Proceedings of the 4th International Tropical Renewable Energy Conference (i-TREC)—Sustainable Energy and Environment for Tropical Climate, Bali, Indonesia, 14–16 August 2019.
15. Bukit, F.R.A.; Zulkarnaen, H.; Simarmata, G.D.A. Minimize the cost of electricity generation with hybrid power plants on pemping island of indonesia using HOMER. In Proceedings of the 2020 4th International Conference on Electrical, Telecommunication and Computer Engineering, ELTICOM, Medan, Indonesia, 3–4 September 2020; pp. 153–157.
16. Yang, Y.C.; Javanroodi, K.; Nik, V.M. Climate Change and Renewable Energy Generation in Europe-Long-Term Impact Assessment on Solar and Wind Energy Using High-Resolution Future Climate Data and Considering Climate Uncertainties. *Energies* **2022**, *15*, 302. [CrossRef]
17. Halabi, L.M.; Mekhilef, S.; Olatomiwa, L.; Hazelton, J. Performance analysis of hybrid PV/diesel/battery system using HOMER: A case study Sabah, Malaysia. *Energy Convers. Manag.* **2017**, *144*, 322–339. [CrossRef]
18. Sen, R.; Bhattacharyya, S.C. Off-grid electricity generation with renewable energy technologies in India: An application of HOMER. *Renew. Energy* **2014**, *62*, 388–398. [CrossRef]
19. Shahzad, M.K.; Zahid, A.; Rashid, T.U.; Rehan, M.A.; Ali, M.; Ahmad, M. Techno-economic feasibility analysis of a solar-biomass off grid system for the electrification of remote rural areas in Pakistan using HOMER software. *Renew. Energy* **2017**, *106*, 264–273. [CrossRef]
20. Bahramara, S.; Moghaddam, M.P.; Haghifam, M.R. Optimal planning of hybrid renewable energy systems using HOMER: A review. *Renew. Sustain. Energy Rev.* **2016**, *62*, 609–620. [CrossRef]
21. Ahmad, J.; Imran, M.; Khalid, A.; Iqbal, W.; Ashraf, S.R.; Adnan, M.; Ali, S.F.; Khokhar, K.S. Techno economic analysis of a wind-photovoltaic-biomass hybrid renewable energy system for rural electrification: A case study of Kallar Kahar. *Energy* **2018**, *148*, 208–234. [CrossRef]
22. HOMER Differences between HOMER Pro and HOMER Grid. Available online: <https://www.homerenergy.com/products/pro-vs-grid.html> (accessed on 26 July 2022).
23. Manmadharao, S.; Chaitanya, S.; Rao, B.V.; Srinivasarao, G. Ieee Design and Optimization of Grid Integrated Solar Energy System Using HOMER GRID software. In Proceedings of the IEEE International Conference on Innovations in Power and Advanced Computing Technologies, Vellore, India, 22–23 March 2019.
24. Ghatak, A.; Alfred, R.B.; Singh, R.R. Optimization for Electric Vehicle Charging Station using Homer Grid. In Proceedings of the 3rd IEEE International Virtual Conference on Innovations in Power and Advanced Computing Technologies, i-PACT 2021, Kuala Lumpur, Malaysia, 27–29 November 2021.
25. HOMERGrid. *Homer Grid Software*; HOMER: Boulder, CO, USA, 2022.
26. HOMERPro. *HOMER Help Files*; HOMER: Boulder, CO, USA, 2021.
27. NREL. *National Solar Radiation Database*; NREL: Golden, CO, USA, 2021.
28. NASA. *NASA Prediction of Worldwide Energy Resources (POWER)*; NASA: Washington, DC, USA, 2022.
29. Vermogen, Silent Generator/Genset Diesel—110 kw—Automatic. 2022. Available online: https://mall.shopee.co.id/SILENT-GENERATOR-GENSET-DIESEL-110-KW-OTOMATIS-VERMOGEN-i.266696978.8834295293?sp_atk=b424740c-a94b-4593-abb5-df51fe58e6ef (accessed on 3 November 2021).
30. Cummins. *Generator Cummins Air Cooler Type Genset*; Cummins: Columbus, IN, USA, 2022.
31. IRENA. *Renewable Power Generation Costs in 2020*; International Renewable Energy Agency: Abu Dhabi, United Arab Emirates, 2021.
32. Energy, P. *On Farm Power Generation—Wind Power*; Applied Horticultural Research: Eveleigh, Australia, 2021.
33. Demiroren, A.; Yilmaz, U. Analysis of change in electric energy cost with using renewable energy sources in Gökceada, Turkey: An island example. *Renew. Sustain. Energy Rev.* **2010**, *14*, 323–333. [CrossRef]

34. HOMERGrid. *Homer Grid Software*; HOMER: Boulder, CO, USA, 2021.
35. Bloomberg USD-IDR X-Rate. Available online: <https://www.bloomberg.com/quote/USDIDR:CUR> (accessed on 3 November 2021).
36. Globalpetrolprices, Indonesia Diesel Prices. Available online: <https://www.globalpetrolprices.com/> (accessed on 14 February 2022).
37. The World Bank. *Real Interest Rate (%)—Indonesia*; The World Bank: Jakarta, Indonesia, 2021.
38. The World Bank. *The World Bank in Indonesia*; The World Bank: Jakarta, Indonesia, 2021.
39. Attia, A.M.; Al Hanbali, A.; Saleh, H.H.; Alsawafy, O.G.; Ghaithan, A.M.; Mohammed, A. A multi-objective optimization model for sizing decisions of a grid-connected photovoltaic system. *Energy* **2021**, *229*, 120730. [[CrossRef](#)]