



Institute for

International Studies

Handbook



University of Technology, Sydney

1998

***UTS Institute for
International Studies
Handbook
1998***

The University attempts to ensure that the information contained in this handbook is correct as at 28 November 1997. The University reserves the right to vary any matter described in the handbook at any time without notice.



University of Technology, Sydney

Equal opportunity

It is the policy of the University of Technology, Sydney to provide equal opportunity for all persons regardless of sex, race, marital status, family responsibilities, disability, sexual preference, age, political conviction or religious belief.

Free speech

The University supports the right to freedom of speech and the rights of its members to contribute to the diversity of views presented in our society.

Non-discriminatory language

UTS has adopted the use of non-discriminatory language as a key strategy in providing equal opportunity for all staff and students. Guidelines for the use of non-discriminatory language have been developed and all members of the University community are encouraged to use them.

Editorial and production:

Publications Branch,
Registrar's Division

Cover

UTS – The Global Classroom
UTS congratulates our first group of International Studies students who will spend 1998 studying overseas in the country of their choice.

External Relations Unit

Table of contents

General University Information	5
Preface	5
Addresses and telephone numbers	6
Campus maps	7
Applying for UTS courses	11
UTS Information Centres	11
Principal dates for 1998	12
Institute Information	14
Institute Mission Statement	14
Institute for International Studies	14
Information for Students	14
International Studies Program	17
Majors in the International Studies Program	23
Argentina	23
Australia and the Asia-Pacific Region	25
Chile	28
China	30
Croatia	31
France	33
Germany	35
Greece	37
Indonesia	38
Italy	40
Japan	42
Latin America	44
Malaysia	46
Mexico	48
Poland	50
Russia	52
Slovenia	53
South China	54
South-East Asia	57
Spain	59
Taiwan	61
Thailand	64
Ukraine	65
Special arrangements	67
List of approved substitute subjects	67
Undergraduate courses	71
List of courses	71
Bachelor of Business/Bachelor of Arts in International Studies	72
Bachelor of Arts in Human Movement Studies and in International Studies	73
Bachelor of Arts in Leisure Management and in International Studies	75
Bachelor of Arts in Tourism Management and in International Studies	76

Bachelor of Building in Construction Economics/ Bachelor of Arts in International Studies	78
Bachelor of Building in Construction Management/ Bachelor of Arts in International Studies	80
Bachelor of Design in Fashion and Textile Design/ Bachelor of Arts in International Studies	81
Bachelor of Design in Interior Design/Bachelor of Arts in International Studies	83
Bachelor of Design in Industrial Design/Bachelor of Arts in International Studies	85
Bachelor of Design in Visual Communication/ Bachelor of Arts in International Studies	86
Bachelor of Land Economics/Bachelor of Arts in International Studies	88
Bachelor of Education/Bachelor of Arts in International Studies	90
Bachelor of Engineering, Bachelor of Arts in International Studies, Diploma in Engineering Practice	92
Bachelor of Applied Science in Information Studies/ Bachelor of Arts in International Studies	94
Bachelor of Arts in Social Science and in International Studies	96
Bachelor of Arts in Communication (Journalism) and in International Studies	98
Bachelor of Arts in Communication (Media Arts and Production) and in International Studies	99
Bachelor of Arts in Communication (Public Communication) and in International Studies	101
Bachelor of Arts in Communication (Writing and Contemporary Cultures) and in International Studies	103
Bachelor of Laws/Bachelor of Arts in International Studies	104
Bachelor of Science in Computing Science/ Bachelor of Arts in International Studies	106
Bachelor of Science in Mathematics/Bachelor of Arts in International Studies	108
Bachelor of Mathematics and Finance/Bachelor of Arts in International Studies	110
Bachelor of Nursing/Bachelor of Arts in International Studies	112
Bachelor of Health Science in Acupuncture/ Bachelor of Arts in International Studies	114
Bachelor of Science/Bachelor of Arts in International Studies	116
International Studies for International Students (ISIS)	117
Postgraduate Courses	119
Research Degrees	119
Postgraduate coursework degree program in International Studies	119
Graduate Diploma in International Studies	120
Master of Arts in International Studies	122
Language Studies	124
Language Programs	125
Alphabetical list of subjects	138
Board of Studies	141
Staff list	142
Index	143

General University information

PREFACE

Welcome to the University of Technology, Sydney (UTS), the fourth largest university in New South Wales. UTS has a reputation for delivering quality higher education that meets the needs of the professions, the technologies and the community. It is a multicampus university operating at three major locations in the Sydney metropolitan area – Broadway, Kuring-gai and St Leonards – and offering over 80 undergraduate and 200 postgraduate courses to nearly 22,000 students.

The main work of course development and delivery at UTS is carried out by the Faculties of Business; Design, Architecture and Building; Education; Engineering; Humanities and Social Sciences; Law; Mathematical and Computing Sciences; Nursing; and Science; and the Institute for International Studies. Each of these is responsible for a range of programs across a number of key disciplines.

Every year UTS produces 10 faculty/institute handbooks containing information about all the courses and subjects offered at UTS, and including details of course content, attendance patterns, credit point requirements and combined degrees, plus important faculty and student information.

These handbooks are part of a suite of publications which includes the *UTS Calendar* and the postgraduate and undergraduate student handbooks. The *UTS Calendar* contains the University Act, By-law and Rules, a list of courses offered at the University, and other useful University information. Copies are held in the University's libraries and faculty offices, and may be purchased at the Co-op Bookshop. The student handbooks contain general information about application procedures, academic progression, assistance schemes, and services and facilities offered to students. You will be given a free copy of one of these when you enrol.

If you need more information about the University or its courses, you can contact the UTS Information Service or your faculty office. The University provides a whole range of services for students, and there are plenty of qualified people here to give you help and advice.

We hope you enjoy your time as a student at UTS, and wish you well in your studies.

ADDRESSES AND TELEPHONE NUMBERS

University of Technology, Sydney

Postal address

PO Box 123
Broadway
NSW 2007 Australia

Telephone

(02) 9514 2000
International: +61 2 9514 2000
Fax: (02) 9514 1551

World Wide Web

<http://www.uts.edu.au>

City campus

Broadway

- Building 1 (Tower Building)
1 Broadway, Ultimo
- Building 2
1 Broadway, Ultimo
- Building 3 (Bon Marche Building)
Cnr Harris St and Broadway, Ultimo
- Building 4
Cnr Thomas and Harris Streets, Ultimo
- Building 6
702–730 Harris St, Ultimo
- Broadway Terraces
9, 11 and 13 Broadway, Ultimo
- Magic Pudding Childcare Centre
Thomas St, Ultimo

Haymarket

- Building 5
Cnr Quay St and Ultimo Rd, Ultimo

Blackfriars

- Cnr Blackfriars and Buckland Steets,
Chippendale
- Blackfriars Childrens Centre
Buckland St, Chippendale

Smail Street

- 3 Smail St, Ultimo

Wembley House

- 839–847 George St, Sydney

Harris Street

- 645 Harris St, Ultimo

Student housing

- Bulga Ngurra
23–27 Mountain St, Ultimo
- Geegal
82–84 Ivy St, Ultimo

Australian Technology Park Sydney Ltd

Institute for Sustainable Futures

- Suite 213
National Innovation Centre
Cnr Garden, Cornwallis and Boundary
Streets
Eveleigh NSW 1430
Telephone: (02) 9209 4350
Fax: (02) 9209 4351

Kuring-gai campus

- Eton Rd, Lindfield
(PO Box 222, Lindfield NSW 2070)

St Leonards campus

- Dunbar Building
Cnr Pacific Highway and
Westbourne St, Gore Hill
- Clinical Studies Building, Centenary
Lecture Theatre and West Wing
Reserve Rd, Royal North Shore Hospital
- Gore Hill Research Laboratories
Royal North Shore Hospital

Yarrowood conference and research centre

- 689 Springwood Rd
Yarramundi NSW 2753

Stroud Field Station

- 2605 The Bucketts Way
Booral NSW 2425

CAMPUS MAPS

City campus

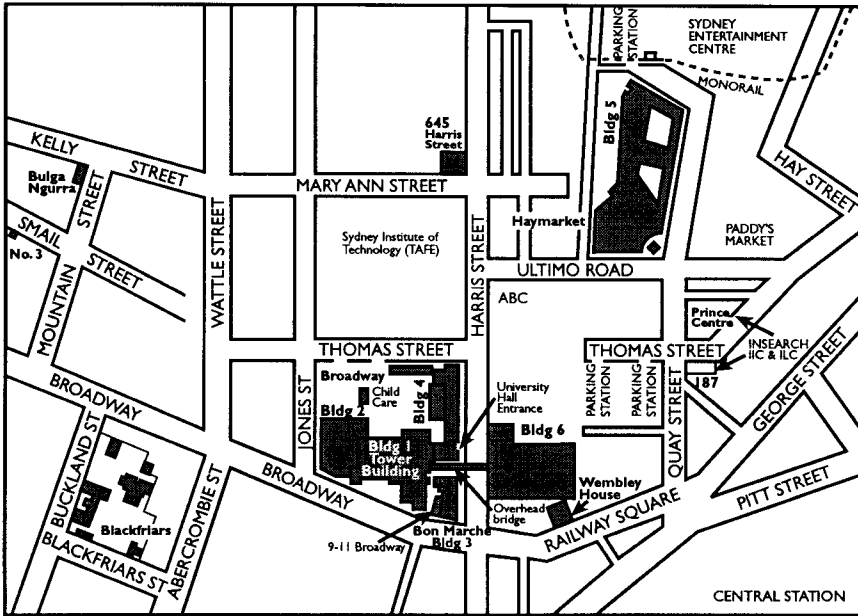

Broadway

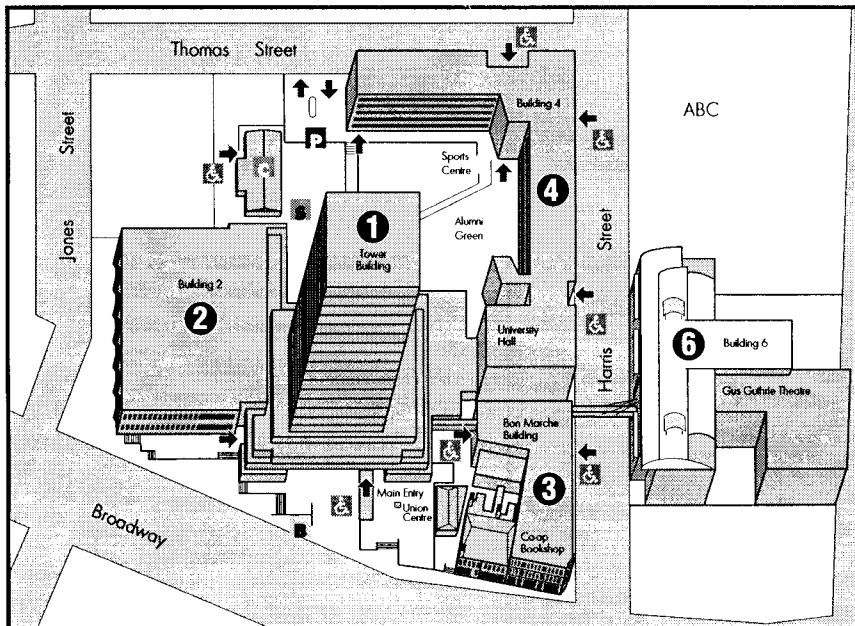

8 GENERAL UNIVERSITY INFORMATION

Haymarket

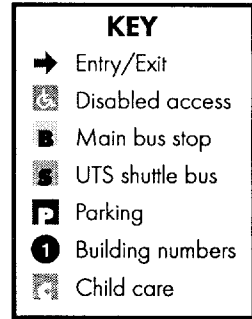
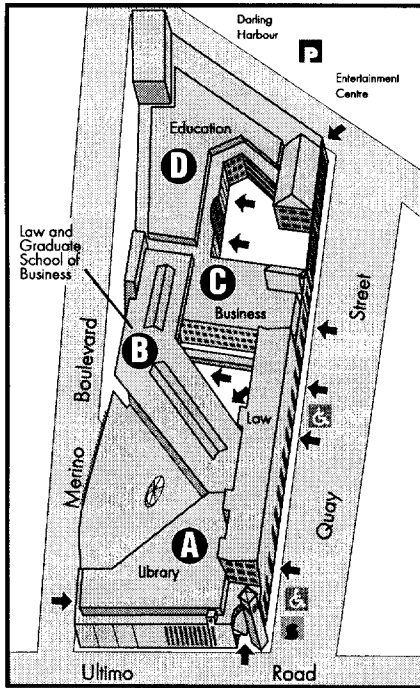

Blackfriars

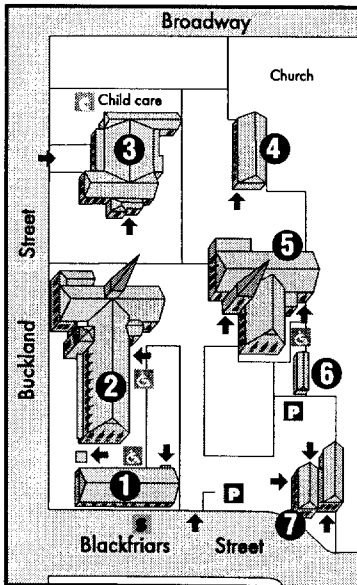

Kuring-gai campus

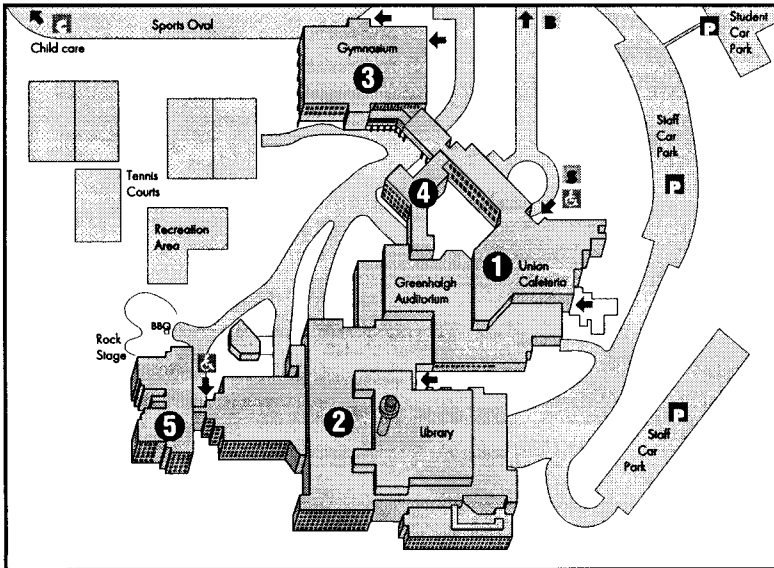
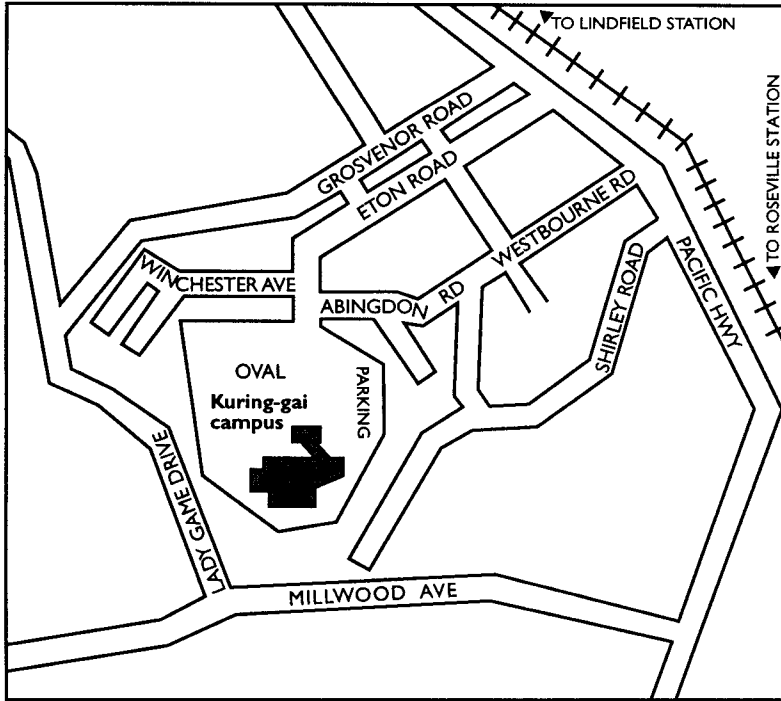

St Leonards campus

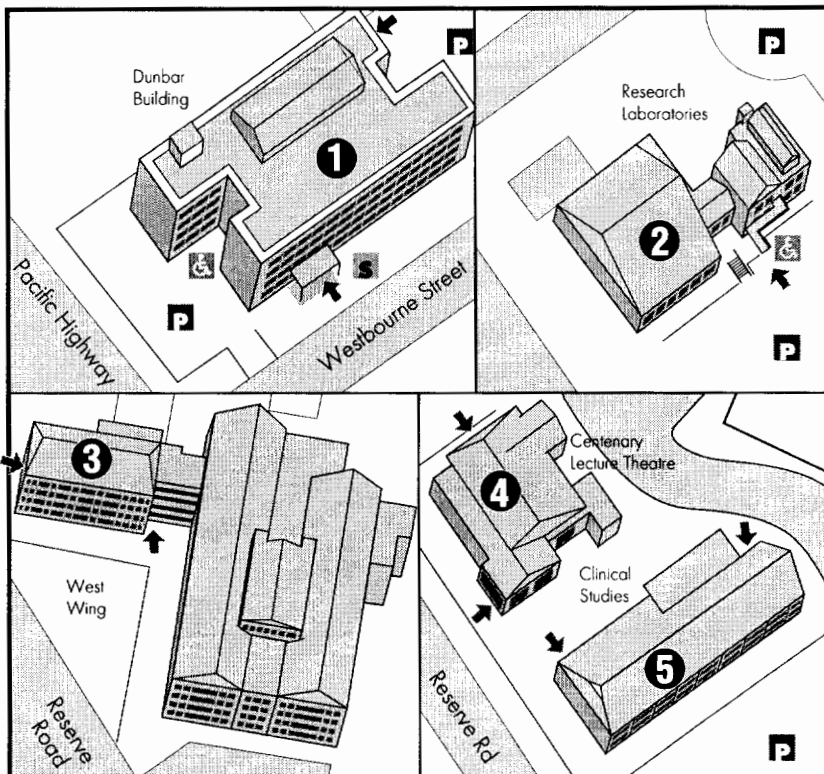
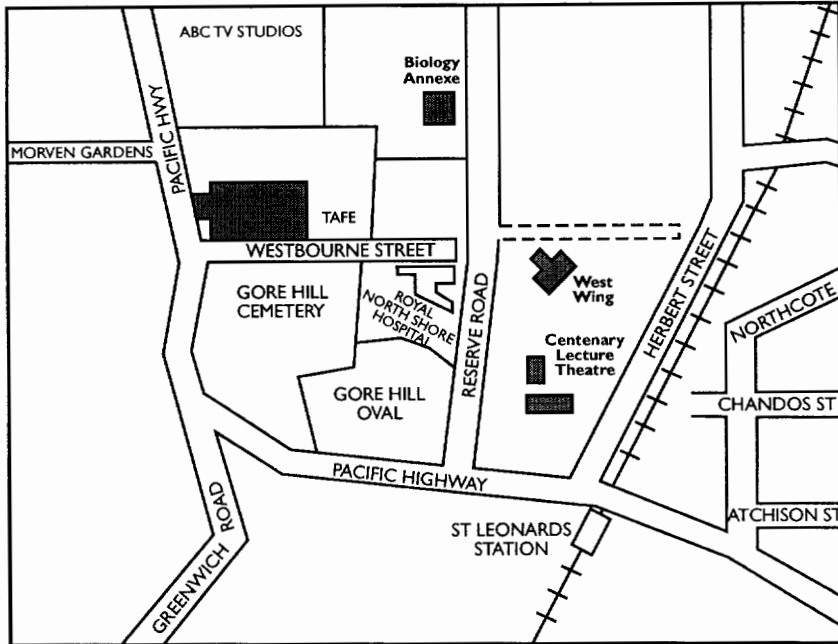

APPLYING FOR UTS COURSES

Undergraduate

Applications for the majority of those undergraduate courses which start at the beginning of each year must be lodged through the NSW and ACT Universities Admissions Centre (UAC) between August and October. Please check the application requirements in the *UAC Guide*, as some of these courses close for applications at the end of September. Some courses are also available by direct application to UTS. These are usually courses that are not available to school leavers.

A small number of UTS courses also start in the middle of the year. Applications for these should be made direct to UTS in May.

Contact the UTS Information Centres for more information.

Postgraduate

Applications for postgraduate courses should be made direct to UTS. For courses starting at the beginning of the year, most applications are open from August to October, but some may have earlier closing dates. For courses

starting in the middle of the year, applications close in May.

Contact the UTS Information Centres for more information.

Non-award and External Award study

Non-award and External Award study allows individuals and students from other universities to study single subjects at UTS. There are four application periods, and closing dates are different for each of the semesters. Some faculties may have special application procedures which will vary depending on the subjects chosen.

Contact the UTS Information Centres for more information.

International students

International students need to satisfy the normal UTS entry requirements and be proficient in English. For details on courses, fees and application procedures, contact International Programs.

UTS INFORMATION CENTRES

Street address	Postal address	Telephone/Fax
<i>City campus</i>		
Foyer, Tower Building 1 Broadway	UTS Information Service PO Box 123 Broadway NSW 2007	Telephone: (02) 9514 1222 Fax: (02) 9514 1200
<i>Kuring-gai campus</i>		
Level 5 or 6, Main Building Eton Road Lindfield	Kuring-gai Student Centre PO Box 222 Lindfield NSW 2070	Telephone: (02) 9514 5555 Fax: (02) 9514 5032
<i>International Programs</i>		
Level 5, Tower Building 1 Broadway	International Programs PO Box 123 Broadway NSW 2007	Telephone: (02) 9514 1531 Fax: (02) 9514 1530

Email inquiries

Within Australia – info.office@uts.edu.au

International – intlprograms@uts.edu.au

PRINCIPAL DATES FOR 1998

Autumn semester

January

- 2 Release of HSC results
- 9 Formal supplementary examinations for 1997 Spring semester students
- 9 Closing date for changes of preference to UAC from 1997 NSW and ACT HSC applicants
- 16 Final examination timetable for Summer session
- 23 Main round of offers to UAC applicants
- 26 Australia Day – public holiday
- 26 Public school holidays end
- 28 Closing date for changes of preference to UAC for final round offers
- 28-30 Enrolment of new undergraduate students at City campus (and 2-4 February)

February

- 2 Last day for continuing students to pay their 1998 service fees
- 2-4 Enrolment of new undergraduate students at City campus (and 28-30 January)
- 6 Final round of offers (UAC)
- 2-13 Formal examinations for Summer session
- 23 Release of results for Summer session
- 5-26 Enrolment of students at City campus

March

- 2 Classes begin
- 4-5 Enrolment (External award, Non-award and Exchange students)
- 13 Last day to enrol in a course or add subjects
- 20 Last day to pay HECS
- 30 Last day to apply to graduate in Spring semester 1998
- 31 Last day to apply for leave of absence without incurring student fees/charges¹
- 31 Last day to withdraw from a subject without financial penalty¹
- 31 HECS census date

April

- 9 Last day to withdraw from a course or subject without academic penalty¹
- 9 Public school holidays begin
- 10 Good Friday
- 13-17 Vice-Chancellors' Week (non-teaching)
- 14-17 Graduation (Kuring-gai)
- 24 Provisional examination timetable available
- 25 Anzac Day – public holiday
- 27 Public school holidays end

May

- 1 Applications available for undergraduate courses where applicable
- 1 Applications open for available postgraduate courses for Spring semester 1998
- 4-15 Graduation (City)
- 15 Examination masters due
- 29 Closing date for undergraduate and postgraduate applications for Spring semester
- 29 Final examination timetable

June

- 8 Queen's Birthday – public holiday
- 12 Last teaching day of Autumn semester
- 13-30 Formal examination period (and 1-3 July)

July

- 1-3 Formal examination period (and 13-30 June)
- 3 Autumn semester ends
- 3 Public school holidays begin
- 6-10 Vice-Chancellors' Week (non-teaching)
- 13-17 Formal alternative examination period for Autumn semester students
- 20 Public school holidays end
- 24 Release of Autumn semester examination results; two days earlier via UniPhone™
- 27 Formal supplementary examinations for Autumn semester students

Spring semester

August

- 3 Classes begin
- 3 Applications available for undergraduate and postgraduate courses for Autumn semester 1999
- 7 Last day to withdraw from full year subjects without academic penalty¹
- 14 Last day to enrol in a course or add subjects
- 31 Last day to apply for leave of absence without incurring student fees/charges (Spring enrolments only)¹
- 31 Last day to withdraw from a subject without financial penalty¹
- 31 Last day to apply to graduate in Autumn semester 1999
- 31 HECS census date

September

- 11 Last day to withdraw from a course or subject without academic penalty¹
- 25 Provisional examination timetable available
- 25 Public school holidays begin
- 28 Vice-Chancellors' Week (non-teaching) begins
- 28-30 Graduation (City)
- 30 Closing date for undergraduate applications via UAC (without late fee)
- 30 Closing date for inpUTS Special Admission Scheme applications

October

- 1-2 Graduation (City)
- 2 Vice-Chancellors' Week (non-teaching) ends
- 5 Labour Day – public holiday
- 12 Public school holidays end
- 16 Examination masters due
- 30 Final examination timetable available
- 30 Closing date for undergraduate applications via UAC (with late fee)

- 30 Closing date for undergraduate applications direct to UTS (without late fee)
- 30 Closing date for most postgraduate courses for Autumn semester 1999 (some courses may have earlier closing dates in September)
- 30 Closing date for Australian Postgraduate Awards, the R L Werner and University Doctoral scholarships

November

- 13 Last teaching day of Spring semester
- 14-30 Formal examination period (and 1-4 December)
- 30 Closing date for Undergraduate applications via UAC (with late fee)

December

- 1-4 Formal examination period (and 14-30 November)
- 4 Spring semester ends
- 14-18 Formal alternative examination period for Spring semester students
- 18 Public school holidays begin
- 21 Release of Spring semester examination results; two days earlier via UniPhone™

¹ HECS/Postgraduate course fees will apply after the HECS census date (31 March and 31 August or last working day before).

Note: Information is correct as at 6 November 1997. The University reserves the right to vary any information described in Principal Dates for 1998 without notice.

Institute information

INSTITUTE MISSION STATEMENT

The Institute for International Studies at UTS is responsible for assisting the University to contribute effectively to Australia's economic development and international stature by providing information and resources that make UTS staff alert to international developments and trends, and UTS graduates internationally competitive. It is committed to improving the quality of teaching and research at UTS by facilitating active international links with higher education institutions, business, industry and the professions, with particular emphasis given to the Asia-Pacific region.

INSTITUTE FOR INTERNATIONAL STUDIES

The Institute for International Studies is concerned with the study of comparative social change and cultural diversity, particularly in East Asia and South-East Asia, Latin America and Europe.

The Institute has a wide-ranging long-term agenda that includes:

- the teaching of an undergraduate program in International Studies;
- the organisation and coordination of teaching languages other than English to all UTS students;
- the teaching and coordination of post-graduate studies in International Studies;
- participation in and encouragement of research projects involving International Studies;
- the provision of an advisory service to business and government; and,
- cooperation with other parts of the University to promote and present UTS and the internationalist aspects of its activities.

The Institute is both a teaching and a research institution, responsible for the coordination of International Studies at UTS and the implementation of its own teaching programs.

The Institute has a Board of Studies with representation from each faculty at UTS. The Chair of the Board of Studies is the Deputy Chair of the Academic Board. The Institute also has an Advisory Council, whose most important function is to link the Institute with the wider world, particularly government agencies and the business community.

This handbook provides an introduction to International Studies at UTS and specific information on the International Studies program. Undergraduate courses and post-graduate courses in International Studies, and language studies organised by the Institute are detailed in separate sections.

The Institute is located at 9-11 Broadway. The telephone number of the office is 9514 1574; the number for teaching and student matters is 9514 1469; the fax number is 9514 1578; and the email address is iisinfo@uts.edu.au

INFORMATION FOR STUDENTS

Technological change, the emergence of a more integrated world and the movement of people during the second half of the 20th century have dramatically increased the importance of the international dimensions of our lives. In all aspects of life and work, contemporary graduates need to be aware of the wider world. UTS aims to enhance its graduates' understanding of other cultures and societies through the International Studies program.

The Institute for International Studies assists in increasing awareness and understanding of international matters, particularly in the non-English-speaking world through its teaching in a number of ways. Students may follow the International Studies program within a combined degree or study some of its language and Contemporary Society subjects as electives in any other UTS degree course. Graduate students may study a language and culture other than English in order to supplement their professional or workplace experience through the Postgraduate Coursework Degree Program.

All subjects are offered subject to the approval of the Board of Studies of the Institute for International Studies and the Academic Board of UTS. Where there are sufficient student numbers, units of instruction will be taught at UTS campuses. In other cases, arrangements may be made for students to attend classes at other universities.

While every effort has been made to ensure that the details provided in this handbook are correct at the time of printing, the University reserves the right to vary any program.

The International Studies program consists of a number of majors that introduce students to a specific country or culture. The following majors are offered: Argentina, Chile, China, Croatia, France, Germany, Greece, Indonesia, Italy, Japan, Latin America, Malaysia, Mexico, Poland, Russia, Slovenia, South China, South-East Asia, Spain, Taiwan, Thailand and Ukraine. Details of each major are provided in this handbook. The Institute also offers an Australia and the Asia-Pacific Region major for international students. Details of this major are provided in the Majors section of this handbook.

In addition to the International Studies program, the Institute for International Studies organises and coordinates the teaching of languages other than English for all UTS students.

In some cases, Language and Culture programs are taught at UTS by the Institute. In other cases, the Institute has made arrangements for UTS students to attend language studies at other universities in the Sydney area. It is also possible for individual arrangements to be made for students to study other languages elsewhere.

The Institute offers language programs in Cantonese, Chinese, Croatian, French, German, Greek, Indonesian, Italian, Japanese, Korean, Malaysian, Polish, Russian, Slovenian, Spanish, Thai and Ukrainian. The Institute can arrange for the teaching of other language programs depending on availability and demand.

More information may be found in the Language Studies section of this handbook.

Undergraduate combined degree program

The combined degree program in International Studies at UTS is designed to produce graduates who are primarily trained in a professional or practical discipline, but who also have a substantial knowledge and appreciation of a non-English-speaking culture. In the case of international students, the program combines their professional discipline with a knowledge of English and of Australia and the Asia-Pacific Region.

In addition to their professional degree program, students who undertake the combined degree program follow an International Studies major that concentrates on a specific country or region. Students learn about its language and culture, study its contemporary society and spend two semesters studying there.

International Studies majors are available on Argentina, Chile, China, Croatia, France, Germany, Greece, Indonesia, Italy, Japan, Latin America, Malaysia, Mexico, Poland, Russia, Slovenia, South China, South-East Asia, Spain, Taiwan, Thailand and Ukraine. Australia and the Asia-Pacific Region is available as a major for international students.

Combined degree programs are available with all faculties.

The International Studies component of any combined degree amounts to the equivalent of two years of full-time academic study or 96 credit points. It is studied concurrently with the major discipline of study in an integrated program. Combined degrees have been structured to facilitate the study of two separate programs at the same time.

Each combined degree program has a Course Coordinator in the appropriate faculty. Inquiries about a specific combined degree program should be addressed to the relevant Course Coordinator.

Combined degree students enrol at the University through the faculties. However, at University enrolment time students need to register for the International Studies subjects they intend to take for the year.

Outlines of the combined degrees and their International Studies components are provided in the Undergraduate courses and Postgraduate courses sections of this handbook.

Postgraduate studies

The Institute for International Studies accepts research students to study for higher degrees and offers a Postgraduate Coursework Degree Program in International Studies – the Graduate Diploma in International Studies and the Master of Arts in International Studies.

Research in the Institute for International Studies focuses on contemporary social, political, economic and cultural change, and research students are usually only accepted in this area of investigation.

The Postgraduate Coursework Degree Program in International Studies provides graduates from a variety of disciplinary backgrounds with the opportunity to study a language and culture other than English. Students study for one year full time (or two years part time) to obtain the Graduate Diploma in International Studies. They may then continue to study for the Master of Arts in International Studies, which involves an additional year of full-time study. The Graduate Diploma is a prerequisite for the Master of Arts in International Studies.

Further information on postgraduate opportunities and details of the Postgraduate Coursework Degree Program may be found in the Postgraduate Courses section of this handbook.

Electives and non-award studies

Language and Culture subjects and Contemporary Society subjects are available as electives to undergraduate and postgraduate students at UTS. In some cases sub-majors combining three elective subjects in International Studies – International Studies, Specialist Country Studies and LOTE (Language other than English) – are available to UTS students.

Enrolment in subjects as electives or in a sub-major in International Studies needs to be endorsed by the faculty in which the student's degree is based and approved by the Institute for International Studies. Students intending to take International Studies subjects as electives in their existing degree need to register with the Institute.

The procedures are as follows:

1. Obtain subject numbers and a registration confirmation form from the Institute for International Studies.

2. Obtain permission from your faculty or school to take the subjects as part of your degree.
3. Complete the registration form and return it to the Institute for International Studies in person or by mail or fax.
4. Complete an enrolment form or a variation form and submit it to the UTS Information Services of the University, or to your faculty or school.

Students intending to take International Studies subjects as electives are advised to contact the Institute at the earliest opportunity.

International Studies subjects are also available to non-award students and students from other universities.

Enrolments in non-award studies need to be processed through the Institute for International Studies and by the Non-Award Studies Officer at the UTS Undergraduate Admissions Office, telephone 9514 1559.

The Institute is located at 9–11 Broadway. The telephone number for teaching and student matters is 9514 1469, the fax number is 9514 1578, and the email address is iisinfo@uts.edu.au

Eligibility for Austudy

Austudy provides financial help to full-time students who meet its income and assets requirements. Application forms and information about Austudy eligibility are available from offices of the Student Services Unit at the City and Kuring-gai campuses. **Students who receive Austudy and decide to drop subjects during the semester need to be aware that to remain eligible for Austudy they must be enrolled in a minimum of 18 credit points or have a HECS liability for the semester of .375.** The only exceptions made are for students with disabilities which interfere with their studies, students who are single supporting parents or those who have been directed by the University to reduce their study load. Student Welfare Officers in the Student Services Unit can assist students who wish to apply for exceptions on these grounds.

International Studies ***program***

The International Studies program introduces students to languages and cultures of the non-English-speaking world and teaches students about contemporary societies in East Asia, South-East Asia, Europe and Latin America. The programs provide opportunities for students to study overseas for an academic year at an institution of higher education in the country or countries of their International Studies major. For international students it allows students to further their study of English and of Australia and the Asia-Pacific region.

The key element in the International Studies program is a period of study overseas. In preparation for this, the study of the language and culture, contemporary society, and political and economic structure of the relevant country is necessary.

The following majors are available in the International Studies program: Argentina, Chile, China, Croatia, France, Germany, Greece, Indonesia, Italy, Japan, Latin America, Malaysia, Mexico, Poland, Russia, Slovenia, South China, South-East Asia, Spain, Taiwan, Thailand and Ukraine. Australia and the Asia-Pacific Region is available as a major to international students.

Structure of the International Studies program

The programs require both undergraduate students and postgraduate students by coursework to follow a single major – a specialisation in a country or region.

Undergraduate students studying for the Bachelor of Arts in International Studies study four sequential subjects that focus on a relevant Language and Culture, one subject that introduces students to the study of comparative social change, one subject that examines contemporary society and spend two semesters at an institution of higher education in a country of their major.

Language and Culture 1–4: four subjects, four semesters	8cp each
Modernisation and Social Change: one subject, one semester	8cp
Contemporary Society: one subject, one semester	8cp
In-country Study 1–2: two subjects, two semesters o/seas	24cp each
Total: 96cp	

Postgraduate students studying for the Graduate Diploma in International Studies are required to study two sequential subjects that focus on a relevant Language and Culture, one subject that introduces students to the study of comparative social change, one subject that examines contemporary society, and approved elective subjects to the value of 16 credit points.

Language and Culture 1–2: two subjects, two semesters	8cp each
Modernisation and Social Change: one subject, one semester	8cp
Contemporary Society: one subject, one semester	8cp
Approved electives total	16cp
Total: 48cp	

Completion of the Graduate Diploma in International Studies is the prerequisite for admission to the Master of Arts in International Studies. Postgraduate students studying for the Master of Arts in International Studies are required to undertake at least one semester of In-country Study (24 credit points), followed by either another semester of In-country Study, a dissertation in International Studies or a Professional Studies Specialisation, each amounting to 24 credit points.

In-country Study 1: one subject, one semester	24cp
One of the following: one semester	24cp
– In-country Study 2	
– Dissertation	
– Professional Studies Specialisation	

Total: 48cp

Students are admitted to the International Studies program with no guarantee of entry to a specific major, although every effort is made to meet students' preferences. The Institute reserves the right to allocate places in majors according to its resources and arrangements with overseas universities.

Note: In general, the International Studies programs have no prior language requirement, except for entry to the Greece, Poland, Slovenia and Ukraine majors which are restricted to students who have a sound working knowledge of the language of their selected specialisation.

Each student's choice of major and subjects requires the approval of the Board of Studies of the Institute for International Studies.

In exceptional circumstances, students may, with the approval of the Board of Studies of the Institute for International Studies, vary the designated subjects in their International Studies major. Refer to the List of Approved Substitute Subjects in this handbook.

Language and Culture

Language and Culture subjects are an important part of the International Studies program. They are designed to prepare UTS students for further study in a country of their International Studies major.

Students are encouraged to study a language other than English not only to gain a communication tool but also to gain an understanding of other cultures and societies. The International Studies program does not give exemptions for any previous study of languages. The Language and Culture subjects admit students at different levels and are able to meet various levels of linguistic competence in order to enhance each student's communicative ability.

Students who start a language at beginner's level on their entry to the International Studies program can expect to acquire survival language skills for their period of In-country Study, and to lay a strong foundation for further language acquisition after graduation.

Students with competence in, or exposure to, a language they intend to study are admitted to the Language and Culture subjects at a higher level appropriate to their existing ability in that language. These students are expected to develop or improve their skills in speaking, comprehension, reading and writing. Through the process of language acquisition, students

are also encouraged to obtain an insight into the relevant culture.

In making its arrangements for the acquisition of language, the International Studies program differentiates between subjects of enrolment and units of instruction. Students in the International Studies program follow a specific Language and Culture program by enrolling in a series of subjects – four for undergraduates in a combined degree with a Bachelor of Arts in International Studies and two for postgraduates in the Postgraduate Coursework Degree Program in International Studies. The subject numbers refer to the sequence of study at UTS and not to the precise contents of the units of instruction. The units of instruction attended by each student are determined by their level of language proficiency. All individual choices of units of instruction are subject to the approval of the Board of Studies of the Institute for International Studies.

In exceptional circumstances, students with an advanced working competence in a language may be exempted from further language study but will be required to substitute alternative subjects. Further details are provided under the regulations for Special Arrangements, located in the Majors in the International Studies program section of this handbook. Any amendments to the individual student's International Studies program are also subject to the approval of the Board of Studies of the Institute for International Studies.

The Language and Culture subjects of the International Studies program are open as electives to all UTS students. Further details may be found in the Language Studies section.

Modernisation and Social Change

Contemporary Society

In each major of the International Studies program, students take two specific subjects which provide an introduction to the history, politics, economics and society of the country or region of their International Studies major.

The first subject is Modernisation and Social Change, which provides an introduction to comparative social change in Europe, Latin America, East Asia and South-East Asia. All students take this subject to help them locate the culture of their major in its intellectual, social and political contexts.

Modernisation and Social Change is offered in collaboration with the Faculty of Humanities and Social Sciences.

The second is a Contemporary Society subject, which provides an introduction to a specific country or region in order to ensure that students gain an understanding of its political, social and economic structures, and to identify its more dynamic aspects. No prior knowledge of the culture or skills in the language concerned are required, and all teaching is conducted in English. Contemporary Society subjects are taught by the Institute.

The following Contemporary Society subjects are taken in each major:

Argentina	Contemporary Latin America
Chile	Contemporary Latin America
China	Contemporary China
Croatia	Contemporary Europe
France	Contemporary Europe
Germany	Contemporary Europe
Greece	Contemporary Europe
Indonesia	Contemporary South-East Asia
Italy	Contemporary Europe
Japan	Contemporary Japan
Korea	Contemporary Korea
Latin America	Contemporary Latin America
Malaysia	Contemporary South-East Asia
Mexico	Contemporary Latin America
Poland	Contemporary Europe
Russia	Contemporary Europe
Slovenia	Contemporary Europe
South China	Chinese East Asia
South-East Asia	Contemporary South-East Asia
Spain	Contemporary Europe
Taiwan	Chinese East Asia
Thailand	Contemporary South-East Asia
Ukraine	Contemporary Europe

Modernisation and Social Change and Contemporary Society subjects are open as electives to all UTS students.

In-country Study

The overall aim of the In-country Study program is for students to be immersed in the culture of another country by participating in the learning program at the host university, through their involvement in the life of the local community and through their assessable project work.

Undergraduate students undertaking a combined degree with a Bachelor of Arts in International Studies spend two semesters of In-country Study at a university or institution of higher education overseas, determined by the student's International Studies major. Two subjects are required:

UTS Autumn semester: In-country Study 1

UTS Spring semester: In-country Study 2

Programs of study depend on the level of language competence attained by the individual student before departure in the language of the student's major, and the range of subjects available at the host institution.

Student placements at overseas universities and institutions of higher education are arranged, administered and assessed by the Institute for International Studies. All students are expected to complete their programs of In-country Study at host universities, including all examinations and other requirements. Assessment for the subjects In-country Study 1 and In-country Study 2 is based on a combination of moderated assessment from the overseas institution and additional project work, with the overall assessment decided by the Institute.

Postgraduate students undertaking the Master of Arts in International Studies are required to spend one semester at a university or institution of higher education overseas, in a country determined by the student's International Studies major. A second semester of In-country Study is optional within the student's International Studies program. The precise content of In-country Study will vary with each major, the language proficiency of the individual student and the opportunities available.

Admission

Under normal circumstances, students can only proceed to a period of In-country Study within the International Studies program after they have successfully completed all earlier stages in the degree program. Students who have not successfully completed all earlier

stages may proceed to a period of In-country Study only with the permission of both the Dean of the faculty in which their degree is based and the Director of the Institute for International Studies.

Conditions of Participation for In-country Study

Before students engage in a period of In-country Study, they may be required to meet appropriate financial and enrolment requirements. They are also required to agree to be governed by the Institute's Conditions of Participation for the period of In-country Study and to abide by the rules and regulations of the host institution and the laws of the host country. The *Conditions of Participation* follow:

As a student of UTS participating in a period of In-country Study within the International Studies program, I understand that I remain subject to the rules and regulations of UTS and undertake to:

1. *accept financial responsibility for all personal expenses, including accommodation and food, during a period of In-country Study;*
2. *meet all academic requirements that precede the period of In-country Study;*
3. *participate in any pre-departure preparation specified by the Institute for International Studies;*
4. *advise the appropriate faculty and the Institute of any changes in an academic program while overseas in accordance with applicable UTS dates and the guidelines of the Institute for International Studies;*
5. *arrange for UTS Students' Association fees to be paid each semester during the period of In-country Study;*
6. *abide by advice from the Student Administration Unit regarding HECS payments, re-enrolment proxies, and examination assessments;*
7. *abide by the laws of the host country;*
8. *abide by the regulations of the host institution;*
9. *behave personally and professionally in an appropriate manner for a representative of UTS;*
10. *consult with staff of the Institute for International Studies and advisers at the host institution should any problems arise in relation to academic or other matters during a period of In-country Study.*

I understand that failure to abide by these conditions may result in disciplinary action.

Prerequisites

Before undertaking the subject In-country Study 1, students will need to have successfully completed the required subjects in their International Studies program. These subjects are listed in the Majors outlines of this handbook.

Before undertaking In-country Study 2, students will need to have successfully completed In-country Study 1.

Content and assessment

Students with a basic level of language competence will usually follow a program of study which will continue to develop their knowledge and understanding of the host country's language and culture. Those whose level of language competence is adequate will study subjects related to the development of the contemporary society – history, economics, politics, society and culture – of the host country alongside students from that country. Those whose level of language competence and understanding of local culture is close to that of a native speaker may choose freely from a wide range of subjects with the approval of the host university and the Institute for International Studies.

In all cases, students will undertake a reduced study load at the host institution. In addition to the classes attended, all students will be expected to complete assignments and project work administered by the Institute for International Studies, and these, together with a satisfactory report from the host institution, will be the basis for assessment.

Partner universities hosting In-country Study programs

Argentina

Universidad Nacional de San Luis, San Luis
Universidad Nacional de Córdoba, Córdoba

Chile

Pontificia Universidad Católica de Chile,
Santiago
Universidad de Concepción, Concepción

China

Zhejiang University, Zhejiang College of
Traditional Medicine, Hangzhou

Croatia

University of Zagreb, Zagreb

France

Université de Reims – Champagne-Ardenne,
Reims
Université Lumière Lyon 2, Lyon
Université Rennes 2 – Haute Bretagne,
Rennes
Université de Toulon et du Var, La Garde,
Toulon

Germany

Gerhard Mercator Universitaet of Duisburg,
Duisburg
Universitaet des Saarland, Saarbrücken
Hochschule für Wurtshaft u. Politik (HWP),
Hamburg

Indonesia

Universitas Gadjah Mada, Yogyakarta

Italy

University of Bologna, Bologna
University of Siena for Foreigners, Siena
University of Florence, Florence

Japan

Hokkaido University of Education,
Hakodate Campus, Hokkaido
Kyoto University of Foreign Studies, Kyoto
Yokohama National University, Yokohama
Yamanashi University, Kofu
Obirin University, Machida, Tokyo
Yamahashi University, Kofu

Malaysia

Universiti Sains Malaysia, Penang
Universiti Malaysia Sarawak

Mexico

Instituto Tecnológico y de Estudios
Superiores de Monterrey (ITESM),
Monterrey

Poland

University of Warsaw, Warsaw

Russia

St Petersburg State Technical University

South China

Zhongshan University, Guangzhou
Hong Kong University of Science and
Technology

Spain

Autonomous University of Barcelona,
Barcelona
University of Malaga, Malaga
University of Salamanca, Salamanca

Taiwan

National Chengchi University, Taipei

Thailand

Khon Kaen University, Khon Kaen

Ukraine

University of Kiev–Mohyla Academy

Academic support and pastoral care

In-country academic advisers from each host university will assist the Institute's staff in monitoring students' progress and providing academic support and pastoral care. At the end of each semester of In-country Study, the host university will report to the Institute on each student's progress. Country coordinators from the Institute for International Studies will visit each student at least twice during their in-country placement and regular contact will be maintained with students and with the host universities' academic advisers.

Before departure, students will receive both a subject outline and a detailed Study Guide which together will outline the Study Program for each host university including the range of subjects available, assessment guidelines and criteria and advice on practical matters associated with settling into the life of the local community. The Study Guide will also include contact numbers for Australian embassies and consulates who will be advised of students' names and programs of study prior to their departure from Australia.

Alternative arrangements

Some students may find it impossible to leave or stay away from Australia for a whole year for a variety of reasons. The Institute will maintain a system of pastoral care. In special cases provision will be made for students to vary their program of study to fit individual circumstances. Under those circumstances students may be required to complete their International Studies program by taking subjects from the List of Approved Substitute Subjects in this handbook. Any variation in the International Studies program is subject to the approval of the Board of Studies of the Institute. The Institute reserves the right to vary the In-country Study component of the International Studies program in the event of unsafe conditions in a particular region.

Costs

In-country Study 1 and In-country Study 2 are full credit subjects at UTS for which HECS is payable. Students receiving Austudy in Australia are still eligible to receive it while they are engaged in the period of In-country Study.

The costs of tuition in host institutions overseas and travel between Sydney and the designated host institutions are borne by UTS except in cases where a scholarship has been awarded

to the student with provision for these costs. Under those circumstances, the funds that would have otherwise been allocated towards the student's tuition and travel will be redirected to support the In-country Study program in general. Visa fees are also paid by UTS and students are covered by the UTS Student Travel Insurance policy. Students are responsible for accommodation and other living costs during the period of In-country Study. The UTS medical service is available to students for medical examinations for visas, vaccinations and other country specific health advice.

In-country Study for Engineering students

Students enrolled in the combined degree of Bachelor of Engineering and Bachelor of Arts in International Studies have separate arrangements for periods of In-country Study and industrial experience. The Institute for International Studies is not responsible for In-country Study undertaken by Engineering students. For further information, see the course description or contact the Director, International Engineering Program in the Faculty of Engineering, telephone 9514 2591.

Majors in the International Studies program

ARGENTINA MAJOR

Outline

Argentina is the second largest country in Latin America (approximately 2,700 km²) and has a varied landscape of mountains, glaciers, lakes, deserts, tropical forests, and vast fertile plains. In the early 20th century, Argentina was one of the wealthiest countries in the world with a resource profile similar to Australia. Since then Argentina has experienced dramatic cycles of authoritarian and populist politics, and the economy entered into long-term decline. Even so, Argentina still enjoys higher standards of living than most of the region. In recent years democracy has returned and the country is undergoing difficult economic reforms. European immigration and cultural influences have made Argentina the most self-consciously 'sophisticated' country in Latin America. Argentine national identity is also rooted in the life and customs of the agricultural pampa.

Language and Culture

971501 Spanish Language and Culture 1	8cp
972501 Spanish Language and Culture 2	8cp
973501 Spanish Language and Culture 3	8cp
974501 Spanish Language and Culture 4	8cp

Contemporary Society

50140 Modernisation and Social Change	8cp
976501 Contemporary Latin America	8cp

In-country Study

97751x In-country Study 1: Argentina	24cp
97851x In-country Study 2: Argentina	24cp

Subject descriptions

971501, 972501, 973501, 974501

Spanish Language and Culture

8cp; 6hpw

This language program is designed for students who are either complete beginners or who first learnt Spanish at school in Australia. There are two points of entry: the first for complete beginners; the second for students who have successfully completed HSC, or its equivalent. Students take four units in the

program, either units 1–4 (beginners) or 3–6 (post-HSC), determined by their point of entry. Students with a language competence in Spanish that is higher than the program offered at UTS may be able to undertake further studies of Spanish at other universities in the Sydney area through arrangements made by the Institute.

The language program is organised to cover a broad range of situations relevant to daily interaction in Spanish. The focus is on the development of speaking, listening, reading and writing skills appropriate to the situations that students are likely to encounter. Vocabulary and grammar are learnt in each subject, which are centred on written and audiovisual materials encompassing a range of themes and situations.

Upon successful completion of the program, students are expected to be able to communicate about familiar things, events and opinions and to have developed skills and strategies for continuing their learning of the language in Spanish-speaking countries. Those students with prior learning of Spanish entering the program at higher level are expected to be able to communicate comfortably on a wide range of themes with the ability to adjust their language according to social variables such as formality, age and status. Each subject will be covered in one semester (13 weeks). There are six hours of language classes per week.

Further descriptions of each subject can be found in the Language Studies section of this handbook.

50140

Modernisation and Social Change

(Faculty of Humanities and Social Sciences)

8cp; 4hpw

The aim of this subject is to provide students with an understanding of the processes of modernisation and social change in a comparative context using case studies in countries of Western Europe, Latin America, East and South-East Asia. The lectures will highlight a number of key issues, for example whether the processes of social change are

universal or specific; the consequences of modernisation in and for the economy, politics, society, culture and ideology of non-Western societies; and whether the established Eurocentric analytical models are still useful in understanding the modern world. It will be emphasised that differing interpretations of modernisation flow from various relations of power which lead to a multiplicity of views on its meanings and significance.

976501

Contemporary Latin America

8cp; 2nd semester, 4hpw

Latin America has been a crucible for social, political and economic change in the 19th and 20th centuries. Intense struggles for nationhood, democracy, economic modernisation, and secularisation, have all resonated in the countries of Latin America. During the middle of the 20th century Latin America's primary concerns were focused on national self-determination, inward industrialisation, and populist authoritarian efforts to legitimise elite rule. In the late 20th century the emphasis has shifted towards economic growth, internationalisation, and pressures to improve the capacity and accountability of governments. The unit aims to prepare students with the historical background, cultural awareness and analytic skills to interpret everyday social, political and economic reality during their period of In-country study. The subject requires no prior knowledge of Latin America or Spanish.

97751x

In-country Study 1: Argentina

24cp; prerequisite: completion of 32 credit points in Language and Culture subjects as appropriate to the student's major

97851x

In-country Study 2: Argentina

24cp; prerequisite: 97751x In-country Study 1: Argentina

Information on In-country Study in Argentina

Content and assessment

Students spend two consecutive semesters studying social science or culture and humanities subjects at one or more institutions of higher education in Argentina through arrangements made by the Institute. The focus

of study varies each semester depending on individual student preferences and the availability of subjects at host institutions. Students are assessed on each semester separately and assessment is based on the subjects undertaken at the host institutions, as well as project work administered by the Institute for International Studies.

Locations

Córdoba

An historic city in the centre of Argentina close to hills and pampa. It is known for its universities, colonial architecture, cultural life, the country's car industry, and lively politics. The Universidad Nacional de Córdoba is Argentina's oldest, founded in 1613. It is still one of the country's best and largest universities with an extensive range of faculties and subject areas.

San Luis

San Luis is a traditional town between Córdoba and the Andean mountain range. It is surrounded by the agricultural pampa, desert, and beautiful hills. The Universidad Nacional de San Luis is a small university which teaches science and engineering, social work, pedagogy, and journalism.

Costs

The two semesters of In-country Study are full-credit subjects at UTS for which HECS is payable. Students receiving Austudy in Australia are still eligible to receive it while they are engaged in a period of In-country Study in Argentina. The costs of tuition in host institutions overseas and travel between Sydney and the designated host institutions are borne by UTS except in cases where a scholarship has been awarded to the student with provision for these costs. Under those circumstances, the funds that would have otherwise been allocated towards the student's tuition and travel will be redirected to support the In-country Study program in general. Argentina is considered an expensive country by Latin American standards, but the average costs of living in Córdoba and San Luis will be lower than in Sydney, and slightly higher than in Chile and Mexico. The information on the program of In-country Study in Argentina is correct at the time of going to press. However, the Institute for International Studies reserves the right to make alterations to the location and content of any program of In-country Study at any time.

AUSTRALIA AND THE ASIA-PACIFIC REGION MAJOR

Outline

The major on Australia and the Asia-Pacific Region is only offered to international students and broadly follows the pattern of other majors in the International Studies program. The major is available from 1998 in all existing degree programs combined with the Bachelor of Arts in International Studies except Engineering, which proposes to introduce the major in 1999.

The language and culture at the core of the major that students are required to attach to their professional degree program is English and the society they are required to study in depth is primarily Australia, and secondarily Australia in its regional context i.e. the Asia-Pacific region. In some faculties, international students in the Australia and the Asia-Pacific Region major of the International Studies program will be able to undertake subjects that enable them to reflect on their professional studies within this regional context.

In general, the English language level for entry to a combined degree program involving International Studies with the Australia and the Asia-Pacific Region major is IELTS 5.5 (with 5.0 in writing) or the TOEFL equivalent. However, students should note that there is some variation across faculties: for combined degrees with Communication the required minimum IELTS entry score is 6.0 (with 6.0 in writing); for Education the required IELTS entry score is 7.0 (with 6.0 in writing). Progress to the second year of the program for international students, in which they commence their professional degree, depends on the student achieving the relevant faculty's required level of English language competence in reading, writing, speaking and comprehension, which is generally IELTS 6.5, with 6.0 in writing, or equivalent; IELTS 7.0 for Communication degrees and IELTS 8.0 for Education.

Students must complete 96 credit points for the Australia and the Asia-Pacific Region major, drawn from the following categories of subjects. A determining factor in the choice and sequencing of subjects is the student's level of English language competence.

Language and Culture

The number and level of subjects taken will be selected to match the student's level of English language competence. The aim is that by the end of Year 1 students will have reached the required entry level for study in their professional degrees. Students who have achieved that goal by the end of Stage 1 of their combined degree will be permitted to take subjects on Australian culture and society in Stage 2 of their first year of study.

59314	Australian English Language and Culture 1	24cp
59315	Australian English Language and Culture 2	24cp
59316	Essay Writing	4cp
59317	Report Writing	4cp
59318	Seminar Presentation	4cp
59319	Communication for Employment	4cp

Contemporary Society

Students must take Modernisation and Social Change and at least one additional contemporary society subject.

50140	Modernisation and Social Change	8cp
xxxxx	Making Australia	8cp
xxxxx	Contemporary Australia	8cp
xxxxx	Australia in the World	8cp

In-country Study

Including subjects from the above two categories, students choose subjects relating to Australia and the Asia-Pacific Region to total 96 credit points. Students in the Australia and the Asia-Pacific Region major may study either subjects related to Australia and/or the Asia-Pacific region, or subjects more related to the practice of their professional studies in an Australian context. The former are largely subjects already taught in the Faculty of Humanities and Social Sciences, the Faculty of Education, or the Institute for International Studies. The latter are subjects to be developed by faculties during 1998 for introduction in 1999 or later. Subjects from which students may choose are listed in the Subject descriptions section of this handbook.

Subject descriptions

59314

Australian English Language and Culture 1

(International students in the Australia and the Asia-Pacific Region major only)
24cp; 20hpw; prerequisite: IELTS 5.5 with 5.0 in writing

This is one of two subjects specifically for international students beginning a Bachelor of Arts in International Studies with a major in Australia and the Asia-Pacific Region. The aim of these intensive subjects is to ensure that by the end of the year students' language and study skills have developed to enable them to successfully participate in classes alongside other UTS students.

This subject focuses on developing the language and learning skills required for tertiary study in an Australian university. It integrates the four macro skills – reading, writing, listening and speaking – into a thematic approach which looks at a variety of contemporary issues in Australian culture and society. These issues are linked to subjects which may be studied in subsequent years in the Bachelor of Arts in International Studies. Students will take a critical/analytical approach to understanding and producing written and spoken texts appropriate for the Australian context.

59315

Australian English Language and Culture 2

(International students in the Australia and the Asia-Pacific Region major only)
24cp; 20hpw; prerequisite: IELTS 6.0 or 59314 Australian English Language and Culture 1

This subject continues the work done in 59314 at a more advanced level. It consolidates the academic skills and cultural knowledge required for successful participation in Australian academic life.

59316

Essay Writing

(English Language Study Skills Assistance (ELSSA) Centre)
4cp; over 9 weeks; prerequisite IELTS 6.5 with 6.0 in writing

This elective is one of four subjects offered by the ELSSA Centre and it is aimed at non-English-speaking background students who

need to develop their essay writing skills. It focuses on the critical analysis of topics relevant to different academic areas of study, the development of essay outlines and the final preparation of essays.

59317

Report Writing

(English Language Study Skills Assistance (ELSSA) Centre)
4cp; over 9 weeks; prerequisite IELTS 6.5 with 6.0 in writing

This elective is one of four subjects offered by the ELSSA Centre and it is aimed at non-English-speaking background students who need to develop their report writing skills. It focuses on the critical analysis of topics relevant to different academic areas of study, the development of report plans and the final preparation of reports.

59318

Seminar Presentation

(English Language Study Skills Assistance (ELSSA) Centre)
4cp; over 9 weeks; prerequisite IELTS 6.5 with 6.0 in writing

This elective is one of four subjects offered by the ELSSA Centre and it is aimed at non-English-speaking background students who need to develop their seminar presentation skills. It focuses on the critical analysis of topics relevant to different academic areas of study, the development of seminar presentation skills and the preparation and presentation of seminars.

59319

Communication for Employment

(English Language Study Skills Assistance (ELSSA) Centre)
4cp; over 9 weeks; prerequisite IELTS 6.5 with 6.0 in writing

This elective is one of four subjects offered by the ELSSA Centre and it is aimed at non-English-speaking background students who need to develop their employment seeking skills. It focuses on the analysis of recruitment advertisements relevant to different academic areas of study, and the development of writing and speaking skills required for gaining employment. It also covers work-related communication skills.

50140**Modernisation and Social Change***(Faculty of Humanities and Social Sciences)**8cp; 4hpw*

The aim of this subject is to provide students with an understanding of the processes of modernisation and social change in a comparative context using case studies in countries of Western Europe, Latin America, East- and South-East Asia. The lectures will highlight a number of key issues, for example whether the processes of social change are universal or specific; the consequences of modernisation in and for the economy, politics, society, culture and ideology of Western societies; and whether the established Eurocentric analytical models are still useful in understanding the modern world. It will be emphasised that differing interpretations of modernisation flow from various relations of power which lead to a multiplicity of views on its meanings and significance.

XXXXX**Making Australia***8cp*

This is the first unit in a sequence of Australian Studies subjects. Students are introduced to Australia through an exploration of four major themes – the indigenous experience of conquest and resistance, the economic and cultural tensions of the city and the bush, the development of masculinity and femininity as social archetypes, and the tensions between foreign ownership and national economic development. These themes are reviewed through an understanding of the development of key political institutions.

XXXXX**Contemporary Australia***8cp*

This is the second unit in a sequence of Australian Studies subjects. Contemporary Australia is a diverse and somewhat divided society – by class, gender, race, ethnicity, sexuality, disability, age and geography. This ambiguity – sometimes celebrated, sometimes feared – emerges as a fundamental coda in Australian cultural and social life. Students explore these issues through a range of learning experiences – in literature, music film/television, cultural institutions, media, recreation and sport. The earlier themes are revisited and extended through these experiences.

XXXXX**Australia in the World***8cp*

This is the third and capstone unit in a sequence of Australian Studies subjects. Globalisation has transformed Australian society – yet its history in the region and the world reverberates in the present. Through an analysis of international relations, and international economic development, Australia is understood as a society which can no longer be European but has yet to become part of the Asia-Pacific. This existence on the borderline between two worlds generates the energy and the reaction that characterise contemporary Australia, its debates over identity and future, and the ways in which it is perceived and acted upon by the outside world.

In-country Study electives related to Australia and the Asia-Pacific Region

- 015110 Aboriginal Cultures and Philosophies
- 52220 Aboriginal Social and Political History
- 50230 Power and Change in Australia
- 50231 Colonialism and Modernity
- 52300 Asian and Pacific Politics
- 52222 International Politics
- 52307 The Making of the Third World
- 52321 Colonialism and Post-Colonialism
- 52316 Power, Race and Ethnicity
- 52302 Comparative Religions
- 976211 Contemporary Japan
- 976111 Contemporary China
- 976101 Chinese East Asia
- 976301 Contemporary South-East Asia
- 97x211 Japanese Language and Culture
- 97x111 Chinese Language and Culture
- 97x121 Cantonese Language and Culture
- 97x320 Thai Language and Culture
- 97x311 Indonesian Language and Culture
- 97x311 Malaysian Language and Culture

Consult the following sections of this handbook for additional subject descriptions:

Language Studies for subject descriptions for languages other than English;

List of Approved Substitute Subjects for subjects offered by the Faculty of Humanities and Social Sciences;

Majors in the International Studies Program for Contemporary Society subjects.

CHILE MAJOR

Outline

Chile runs for some 5,000 kilometres down the west coast mountain spine of Latin America, with the country never wider than 180 kilometres. The landscape is extremely varied, with hot deserts in the north, a fertile 'Mediterranean' heartland, and forests, lakes, and fjords in the south. Chile is often called Latin America's 'tiger' economy. Thanks to successful economic management, Chile has achieved stable growth and is popular with foreign investors. Australia is developing strong links with Chile. Chile is also strengthening ties with Asia through its membership of APEC. Despite extreme political experiments during the 1970s, Chile has now recovered its earlier reputation as one of Latin America's more solid and moderate democracies. The country's 'mestizo' popular culture survives alongside more cosmopolitan cultural and intellectual influences.

Language and Culture

971501 Spanish Language and Culture 1	8cp
972501 Spanish Language and Culture 2	8cp
973501 Spanish Language and Culture 3	8cp
974501 Spanish Language and Culture 4	8cp

Contemporary Society

50140 Modernisation and Social Change	8cp
976501 Contemporary Latin America	8cp

In-country Study

97752x In-country Study 1: Chile	24cp
97852x In-country Study 2: Chile	24cp

Subject descriptions

971501, 972501, 973501, 974501

Spanish Language and Culture

This language program is designed for students who are either complete beginners or who first learnt Spanish at school in Australia. There are two points of entry: the first for complete beginners; the second for students who have successfully completed HSC, or its equivalent. Students take four units in the program, either units 1–4 (beginners) or 3–6 (post-HSC), determined by their point of entry.

Students with a language competence in Spanish that is higher than the program offered at UTS may be able to undertake further studies of Spanish at other universities in the Sydney area through arrangements made by the Institute.

The language program is organised to cover a broad range of situations relevant to daily interaction in Spanish. The focus is on the development of speaking, listening, reading and writing skills appropriate to the situations that students are likely to encounter. Vocabulary and grammar are learnt in each subject, which are centred on written and audiovisual materials encompassing a range of themes and situations.

Upon successful completion of the program, students would be expected to be able to communicate about familiar things, events and opinions and to have developed skills and strategies for continuing their learning of the language in Spanish-speaking countries. Those students with prior learning of Spanish entering the program at higher level would be expected to be able to communicate comfortably on a wide range of themes with the ability to adjust their language according to social variables such as formality, age and status. Each subject will be covered in one semester (13 weeks). There are six hours of language classes per week.

Further descriptions of each subject can be found in the Language Studies section of this handbook.

50140

Modernisation and Social Change

(Faculty of Humanities and Social Sciences)
8cp; 4hpw

The aim of this subject is to provide students with an understanding of the processes of modernisation and social change in a comparative context using case studies in countries of Western Europe, Latin America, East- and South-East Asia. The lectures will highlight a number of key issues, for example whether the processes of social change are universal or specific; the consequences of modernisation in and for the economy, politics, society, culture and ideology of non-Western societies; and whether the established Eurocentric analytical models are still useful in understanding the modern world. It will be emphasised that differing interpretations of modernisation flow from various relations of power which lead to a multiplicity of views on its meanings and significance.

976501**Contemporary Latin America***8cp; 2nd semester, 4hpw*

Latin America has been a crucible for social, political and economic change in the 19th and 20th centuries. Intense struggles for nationhood, democracy, economic modernisation, and secularisation, have all resonated in the countries of Latin America. During the middle of the 20th century Latin America's primary concerns were focused on national self-determination, inward industrialisation, and populist authoritarian efforts to legitimise elite rule. In the late 20th century the emphasis has shifted towards economic growth, internationalisation, and pressures to improve the capacity and accountability of governments. The unit aims to prepare students with the historical background, cultural awareness and analytic skills to interpret everyday social, political and economic reality during their period of In-country study. The subject requires no prior knowledge of Latin America or of Spanish.

97752x**In-country Study 1: Chile***24cp; prerequisite: completion of 32 credit points in Language and Culture subjects as appropriate to the student's major***97852x****In-country Study 2: Chile***24cp; prerequisite: 97752x In-country Study 1: Chile***Information on In-country Study in Chile****Content and assessment**

Students spend two consecutive semesters studying social science or culture and humanities subjects at one or more institutions of higher education in Chile through arrangements made by the Institute. The focus of study varies each semester depending on individual student preferences and the availability of subjects at host institutions. Students are assessed on each semester separately and assessment is based on the subjects undertaken at the host institutions, as well as project work administered by the Institute for International Studies.

Locations**Concepción**

Concepción is a medium-sized coastal city south of the capital Santiago. It is surrounded by forests and fishing villages, with easy access to the lake district, mountains, and Mapuche Indian territories. The university is the third largest in Chile with a wide range of excellent faculties. The picturesque campus near the town centre houses an important museum of Chilean art.

Santiago

One of the more pleasant capital cities in Latin America, Santiago lies at the foot of the Andes mountains. Ski resorts are only one-and-a-half hours by road. The large Pontífica Universidad Católica de Chile is the country's finest university and has an international reputation in many fields. It is famous for its calendar of cultural events.

Costs

The two semesters of In-country Study are full-credit subjects at UTS for which HECS is payable. Students receiving Austudy in Australia are still eligible to receive it while they are engaged in a period of In-country Study in Chile. The costs of tuition in host institutions overseas and travel between Sydney and the designated host institutions are borne by UTS except in cases where a scholarship has been awarded to the student with provision for these costs. Under those circumstances, the funds that would have otherwise been allocated towards the student's tuition and travel will be redirected to support the In-country Study program in general. Other costs e.g. accommodation and food are met by students who may expect that no greater costs will be incurred through undertaking a period of In-country Study in Chile than are involved in living away from home in Sydney.

The information on the program of In-country Study in Chile is correct at the time of going to press. However, the Institute for International Studies reserves the right to make alterations to the location and content of any program of In-country Study at any time.

CHINA MAJOR

Outline

China is one of the world's oldest and farthest-reaching civilisations. It is also one of the fastest growing economies of the 1990s. These characteristics and the relationship between the various Chinese societies make the study of China and Chinese culture particularly important concerns for Australian students.

Language and Culture

971111 Chinese Language and Culture 1	8cp
972111 Chinese Language and Culture 2	8cp
973111 Chinese Language and Culture 3	8cp
974111 Chinese Language and Culture 4	8cp

Contemporary Society

50140 Modernisation and Social Change	8cp
976111 Contemporary China	8cp

In-country Study

977111 In-country Study 1: China	24cp
978111 In-country Study 2: China	24cp

Subject descriptions

971111, 972111, 973111, 974111

Chinese Language and Culture

This program is open to students who are either complete beginners, who first learnt Chinese at secondary school level in Australia or who already have a working knowledge of Chinese characters and communicative competence in a Chinese language other than Modern Standard Chinese. There are three points of entry into this program: Chinese 1 for complete beginners, Chinese 3 for students who have successfully completed HSC 2/3-unit Chinese and Chinese 7 for students who have a working knowledge of Chinese characters as well as communicative competence in a Chinese language other than Modern Standard Chinese. Students take four consecutive units in the program, usually either units 1-4, 3-6 or 7-10, determined by their point of entry. Other programs may be negotiated according to the student's level of proficiency.

The Chinese language program is designed to provide students with the communicative skills necessary to undertake In-country Study in China. A communicative approach is adopted for classroom instruction and students are expected to participate fully in class activities in the process of acquiring

practical language skills. The teaching incorporates an introduction to Chinese culture and helps students to appreciate the wider cultural ramifications of Chinese in various contexts. The program will lay a solid foundation for further cultural studies in Chinese.

In exceptional circumstances, students with advanced skills in Chinese will be excluded from the Chinese Language and Culture program and will be required to substitute other appropriate subjects from the List of Approved Substitute Subjects. These subjects may be other subjects on offer in the International Studies program, including those relating to the study of Contemporary Society or those focusing on another Language and Culture. For details of substitute subjects, see the List of Approved Substitute Subjects section of this handbook. Students interested in studying classical Chinese or Chinese at a level not currently offered at UTS should inquire at the Institute about the possibility of undertaking Chinese subjects offered at other institutions. Students will need to obtain the approval of the Board of Studies of the Institute before they can vary any of their subjects of study in the International Studies program.

Further descriptions of each subject can be found in the Language Studies section of this handbook.

50140

Modernisation and Social Change

(Faculty of Humanities and Social Sciences)
8cp; 4hpw

The aim of this subject is to provide students with an understanding of the processes of modernisation and social change in a comparative context using case studies in countries of Western Europe, Latin America, East and South-East Asia. The lectures will highlight a number of key issues, for example whether the processes of social change are universal or specific; the consequences of modernisation in and for the economy, politics, society, culture and ideology of non-Western societies; and whether the established Eurocentric analytical models are still useful in understanding the modern world. It will be emphasised that differing interpretations of modernisation flow from various relations of power which lead to a multiplicity of views on its meanings and significance.

976111**Contemporary China***8cp; 2nd semester, 4hpw*

This subject examines the contours and dynamics of social, political and economic change in the People's Republic of China since the death of Mao Zedong and the start of the reform era. A central theme is the emerging relationship between state and society in a state socialist system in the process of change and reform. It is an introductory subject that requires no prior knowledge of the People's Republic of China or of any Chinese language.

977111**In-country Study 1: China**

24cp; prerequisite: completion of 32 credit points in Language and Culture subjects as appropriate to the student's major

978111**In-country Study 2: China**

24cp; prerequisite: 977111 In-country Study 1: China

Information on In-country Study in China**Content and assessment**

Students spend two consecutive semesters studying language and culture at Zhejiang University, Hangzhou through arrangements made by the Institute. In the first semester the focus is on the study of language and culture. In the second semester, where possible, the study of language and culture is geared more to the professional training of the students. Students are assessed on each semester separately and assessment is based on the subjects undertaken at the host institutions, as well as project and essay work administered by the Institute for International Studies.

Location**Hangzhou**

Hangzhou is the capital of Zhejiang Province on China's Eastern seaboard just south of Shanghai. The Shanghai hinterland – including Zhejiang and South Jiangsu – has developed rapidly during the 1990s. However, this area, and Hangzhou in particular, has long been a centre of Chinese civilisation. Hangzhou is the home of the Chinese silk industry and a major tea-centre. Hangzhou is one of the most pleasant Chinese cities with a fairly mild

climate and a manageable population crush. Zhejiang University – otherwise known as ZheDa – is one of China's top ten 'key-point' universities and is one of the three leading technological universities. It is particularly well known for its studies of engineering, ophthalmics and economics.

Costs

The two semesters of In-country Study are full-credit subjects at UTS for which HECS is payable. Students receiving Austudy in Australia are still eligible to receive it while they are engaged in a period of In-country Study in China. The costs of tuition in host institutions overseas and travel between Sydney and the designated host institutions are borne by UTS except in cases where a scholarship has been awarded to the student with provision for these costs. Under those circumstances, the funds that would have otherwise been allocated towards the student's tuition and travel will be redirected to support the In-country Study program in general. Students may expect that no greater costs will be incurred through undertaking a period of In-country Study in China than are involved in living away from home in Sydney.

CROATIA MAJOR**Outline**

Croatia is a new state (1991) but an old nation. There are an estimated eight million Croats in the world with about four million living in modern Croatia and its five provinces of Zagorie, Istria, Dalmatia, Slavonia and Dubrovnik. Croatia has been an important contributor to world culture and has also been a major tourist centre along the Dalmatian Coast. There are no language prerequisites for the Croatia major – beginners as well as advanced language learners are accepted. Students in the Croatian major study Croatian language and culture; learn about the history, politics, economics and society of contemporary Croatia; and travel to Croatia to study for one academic year at an institution of higher education.

Language and Culture

971744 Croatian 1	8cp
972744 Croatian 2	8cp
973744 Croatian 3	8cp
974744 Croatian 4	8cp

Contemporary Society

50140	Modernisation and Social Change	8cp
976401	Contemporary Europe	8cp

In-country Study

977741	In-country Study 1: Croatia	24cp
978741	In-country Study 2: Croatia	24cp

Subject descriptions**971744, 972744, 973744, 974744****Croatian**

Croatian language is offered to UTS students through an arrangement with Macquarie University. The Croatian International Studies program accepts beginners as well as more advanced levels. Students are placed in classes appropriate to their level of competence with particular emphasis in furthering pronunciation and writing skills and learning about the history of the Croatian language.

50140**Modernisation and Social Change**

(Faculty of Humanities and Social Sciences)
8cp; 4hpw

The aim of this subject is to provide students with an understanding of the processes of modernisation and social change in a comparative context using case studies in countries of Western Europe, Latin America, East and South-East Asia. The lectures will highlight a number of key issues, for example whether the processes of social change are universal or specific; the consequences of modernisation in and for the economy, politics, society, culture and ideology of non-Western societies; and whether the established Eurocentric analytical models are still useful in understanding the modern world. It will be emphasised that differing interpretations of modernisation flow from various relations of power which lead to a multiplicity of views on its meanings and significance.

976401**Contemporary Europe**

8cp; 2nd semester, 5hpw

This unit is an introduction and an overview laying the groundwork for the study of contemporary Europe. It surveys present-day European Union institutions and sociopolitical developments and provides a comparative study of political and social developments in the countries of Western and Eastern Europe. It aims to provide students with an

understanding of the historical background of the present-day Europe and enable them to identify major contemporary policy issues in this region of the world.

977741**In-country Study 1: Croatia**

24cp; prerequisite: completion of 32 credit points in Language and Culture subjects as appropriate to the student's major

978741**In-country Study 2: Croatia**

24cp; prerequisite: 977741 In-country Study 1: Croatia

Information on In-country Study in Croatia**Content and assessment**

Students spend two consecutive semesters studying language and culture at the University of Zagreb through arrangements made by the Institute. In the first semester the focus is on the study of language and culture. In the second semester, where possible, the study of language and culture is geared more to the professional training of the students. Students are assessed on each semester separately and assessment is based on the subjects undertaken at the host institutions, as well as project and essay work administered by the Institute for International Studies.

Costs

The two semesters of In-country Study are full-credit subjects at UTS for which HECS is payable. Students receiving Austudy in Australia are still eligible to receive it while they are engaged in a period of In-country Study in Croatia. The costs of tuition in host institutions overseas and travel between Sydney and the designated host institutions are borne by UTS except in cases where a scholarship has been awarded to the student with provision for these costs. Under those circumstances, the funds that would have otherwise been allocated towards the student's tuition and travel will be redirected to support the In-country Study program in general. Students may expect that no greater costs will be incurred through undertaking a period of In-country Study in Croatia than are involved in living away from home in Sydney.

The information on the program of In-country Study in Croatia is correct at the time of going to press. However, the Institute for

International Studies reserves the right to make alterations to the location and content of any program of In-country Study at any time.

FRANCE MAJOR

Outline

France is a major European power with a rich historical and cultural heritage. France has and has had a central role in shaping the development of the European Union as well as deep and diverse traditions in literature, ideas, music, theatre and art.

Language and Culture

971414/5 French Language and Culture 1	8cp
972414/5 French Language and Culture 2	8cp
973414/5 French Language and Culture 3	8cp
974414/5 French Language and Culture 4	8cp

Contemporary Society

50140 Modernisation and Social Change	8cp
976401 Contemporary Europe	8cp

In-country Study

97741x In-country Study 1: France	24cp
97841x In-country Study 2: France	24cp

Subject descriptions

Language and Culture

971414/5, 972414/5, 973414/5, 974414/5

French Language and Culture

French Language and Culture is offered at the UTS City campus. The program accepts beginners as well as students at more advanced levels. Students are placed in French classes which are appropriate to their level of competence.

50140

Modernisation and Social Change

(Faculty of Humanities and Social Sciences)
8cp; 4hpw

The aim of this subject is to provide students with an understanding of the processes of modernisation and social change in a comparative context using case studies in countries of Western Europe, Latin America, East and South-East Asia. The lectures will highlight a number of key issues, for example whether the processes of social change are universal or specific; the consequences of

modernisation in and for the economy, politics, society, culture and ideology of non-Western societies; and whether the established Eurocentric analytical models are still useful in understanding the modern world. It will be emphasised that differing interpretations of modernisation flow from various relations of power which lead to a multiplicity of views on its meanings and significance.

976401

Contemporary Europe

8cp; 2nd semester, 5hpw

This unit is an introduction and an overview laying the groundwork for the study of contemporary Europe. It surveys present-day European Union institutions and sociopolitical developments and provides a comparative study of political and social developments in the countries of Western and Eastern Europe. It aims to provide students with an understanding of the historical background of the present-day Europe and enable them to identify major contemporary policy issues in this region of the world.

97741x

In-country Study 1: France

24cp; prerequisite: completion of 32 credit points in Language and Culture subjects as appropriate to the student's major

97841x

In-country Study 2: France

24cp; prerequisite: 97741x In-country Study 1: France

Information on In-country Study in France

There are two separate options for students in the France major. **France A** is for students who have a sound working knowledge of French, which is defined as meeting the entry requirements for the most advanced level of French (usually HSC 3-unit or a good pass in 2-unit French). **France B** is for students who begin to learn French at UTS or whose level of language competence is below that required for France A.

Students in the **France A** option attend university classes in France alongside local students. They spend two consecutive semesters studying at one of the following universities: Université Lumière Lyon 2; Université Rennes 2 – Haute Bretagne;

Université de Reims – Champagne-Ardenne; Université de Toulon et du Var. In general, the focus in the first semester is on language and culture studies. In the second semester students choose their subjects more broadly from the university's curriculum.

Students in the **France B** option attend a program in French language and culture across two semesters at one of the following institutions: the Centre international d'études Françaises (CIEF) at the Université Lumière Lyon 2; the Centre International Rennais d'Études de Français pour Étrangères (CIREFE) at Université Rennes 2 – Haute Bretagne; or the Centre international d'études françaises (CIEF) at the Université de Reims – Champagne-Ardenne.

Students are assessed on each semester separately. Assessment is based on the subjects studied at the host institution, as well as project and essay work administered by the Institute for International Studies.

Locations

Lyon

The Lyon region is a fast growing area of the French economy. It is well integrated with European markets as well as being well-placed for physical contacts with Germany, Italy and Switzerland, all of which are within relatively easy access by road. Lyon itself is a large provincial city, with late medieval and 19th century precincts as well as extensive modern development. The original Université de Lyon was established last century, with the arts and humanities elements becoming the national Université Lumière Lyon 2 in the early 1980s. The university has a campus in the centre of the city, and another much larger at Bron, about 30 minutes from the city centre.

Reims

Reims is the heart of the Champagne region. It is not a large city, but it attracts substantial numbers of tourists because of its cathedral and its associations with Joan of Arc, the King of France and the Holy Roman Emperor. Reims is about one-and-a-half hours from Paris by train and is close to Belgium. The Université de Reims – Champagne-Ardenne is a comprehensive national university and has faculties of science, applied science, health sciences and engineering, as well as of arts and humanities, and wine-making. The current university dates from the post-war era and currently has about 30,000 students who attend a number of different campuses spread throughout the city.

Rennes

Rennes is the capital of Brittany and the centre of Celtic culture and traditions in France. It has a population of about 330,000, of whom 60,000 are students. Rennes is a mixture of late medieval, timbered buildings and elegant 18th and 19th century urban planning. The Atlantic coast is less than an hour away, and Paris is a two-hour trip by TGV (high speed train). The present university was established in 1969 and is one of two universities in Rennes. It has 21,000 students enrolled in five faculties – Languages, Social Sciences, Arts/Letters/Communications, Human Sciences (including Linguistics, Psychology, Education, Sociology) and Physical Education and Sports.

Toulon

Toulon is a port city on the Mediterranean coast, with an impressive naval history. Toulon is part of the French Riviera, with Nice and Marseilles within easy train trips. The Université de Toulon et du Var is located at La Garde, a modern suburb that has grown from an old town approximately 10 kilometres from the port area of Toulon and five kilometres from the beach. The university was established in 1968 and has approximately 10,000 students, enrolled in five faculties – Law, Arts, Economics and Management, Science and Technology, and Engineering. The Université de Toulon also has an associated Technological Institute. The programs at Toulon are best suited for Business students.

Costs

The two semesters of In-country Study are full-credit subjects at UTS for which HECS is payable. Students receiving Austudy in Australia are still eligible to receive it while they are engaged in a period of In-country Study in France. The costs of tuition in host institutions overseas and travel between Sydney and the designated host institutions are borne by UTS except in cases where a scholarship has been awarded to the student with provision for these costs. Under those circumstances, the funds that would have otherwise been allocated towards the student's tuition and travel will be redirected to support the In-country Study program in general. Other costs e.g. accommodation and food are met by students who should be aware that costs of living in France are slightly higher than in Australia. The cost of living in Lyon is marginally higher than in other In-country Study locations in France.

The information on the program of In-country Study in France is correct the time of printing. However, the Institute for International Studies reserves the right to make alterations to the location and content of any program of In-country Study at any time.

GERMANY MAJOR

Outline

Germany is Europe's largest and richest country, and plays a leading and increasingly important role in the politics of the European Community and on the world stage. In addition, Germany has a long history, as well as a rich and varied culture. German is the native language of more than 100 million people world-wide. About one in every 10 books ever published has been in German; and German music traditions have been at the centre of the baroque, classical, and orchestral movements as well as 20th century developments.

There are no restrictions on entry to the Germany major on the International Studies program. Students who already have a sound working knowledge of German on entry to UTS have more options for the development of their study program when they undertake In-country Study in Germany. However, it is also possible to enter the Germany major with no previous knowledge of the German language.

Language and Culture

971424/5	German Language and Culture 1	8cp
972424/5	German Language and Culture 2	8cp
973424/5	German Language and Culture 3	8cp
974424/5	German Language and Culture 4	8cp

Contemporary Society

50140	Modernisation and Social Change	8cp
976401	Contemporary Europe	8cp

In-country Study

97742x	In-country Study 1: Germany	24cp
97842x	In-country Study 2: Germany	24cp

Subject descriptions

971424/5, 972424/5, 973424/5, 974424/5

German Language and Culture

German Language and Culture is offered at the UTS City campus. The program accepts beginners as well as more advanced levels. Students are placed in classes appropriate to their level of competence.

50140

Modernisation and Social Change

(Faculty of Humanities and Social Sciences)
8cp; 4hpw

The aim of this subject is to provide students with an understanding of the processes of modernisation and social change in a comparative context using case studies in countries of Western Europe, Latin America, East and South-East Asia. The lectures will highlight a number of key issues, for example whether the processes of social change are universal or specific; the consequences of modernisation in and for the economy, politics, society, culture and ideology of non-Western societies; and whether the established Eurocentric analytical models are still useful in understanding the modern world. It will be emphasised that differing interpretations of modernisation flow from various relations of power which lead to a multiplicity of view on its meanings and significance.

976401

Contemporary Europe

8cp; 2nd semester, 5hpw

This unit is an introduction and an overview laying the groundwork for the study of contemporary Europe. It surveys present-day European Union institutions and sociopolitical developments and provides a comparative study of political and social developments in the countries of Western and Eastern Europe. It aims to provide students with an understanding of the historical background of the present-day Europe and enable them to identify major contemporary policy issues in this region of the world.

97742x

In-country Study 1: Germany

24cp; prerequisite: completion of 32 credit points in Language and Culture subjects as appropriate to the student's major.

97842x**In-country Study 2: Germany**

24cp; prerequisite: 97742x *In-country Study 1: Germany*

Information on In-country Study in Germany

Content and assessment

Students spend two consecutive semesters studying at either the Gerhard Mercator University of Duisburg, the Universitaet of Saarland, Saarbrücken or at the Hochschule für Wirtschaft u. Politik (HWP) in amburg.

The location and content of each student's period of In-country Study in Germany is determined by the level of their language competence in German. Students who had a sound working knowledge of German before their entrance to UTS – defined as meeting the entry requirements for the most advanced levels of German (usually HSC 3-unit or a good pass in 2-unit German) – can study in any of Duisburg, Hamburg or Saarbrücken. All other students spend two consecutive semesters engaged in the study of German language and culture at the University of the Saarland.

Locations

Duisburg

An industrial city located in the heart of the Ruhr. Duisburg was an old medieval port on the Rhine which has been almost completely rebuilt since the World War II. The Gehard Mercator University of Duisburg was established during the 1950s and is particularly well known for its business, economics and engineering faculties. There are opportunities for work experience placements.

Hamburg

Hamburg is Germany's main northern port and an old Hanseatic City. HWP Hamburg is a small (2,500 students) but prestigious university in the centre of the city's university area. It shares facilities with the University of Hamburg and other adjacent colleges. It has a reputation for non-traditional forms of education and specialises in study of business, law, economics, and politics, society and culture.

Saarbrücken

The Saarland prides itself as being at the crossroads of Europe, and the university (which was established during the 1950s in the former French barracks) has developed courses and subjects accordingly. The university is particularly famous for its computing studies, law and education faculties. It has been a pioneer in bilingual education and the development of European Studies.

Costs

The two semesters of In-country Study are full-credit subjects at UTS for which HECS is payable. Students receiving Austudy in Australia are still eligible to receive it while they are engaged in a period of In-country Study in Germany. The costs of tuition in host institutions overseas and travel between Sydney and the designated host institutions are borne by UTS except in cases where a scholarship has been awarded to the student with provision for these costs. Under those circumstances, the funds that would have otherwise been allocated towards the student's tuition and travel will be redirected to support the In-country Study program in general. However, the cost of living in Germany is high. In parts of Germany it may be as high or higher than in Sydney. On the whole accommodation is cheaper than in Sydney but food is considerably more expensive. Monthly costs in Saarbrücken are about the same as in Sydney, and Duisburg is slightly more expensive. The cost of living in Hamburg is estimated to be the highest in Europe (1996) and it is consequently considerably more expensive to live there than in Sydney.

The information on the program of In-country Study in Germany is correct at the time of going to press. However, the Institute for International Studies reserves the right to make alterations to the location and content of any program of In-country Study at any time.

GREECE MAJOR

Outline

Much of Greece is mountainous, and the landscape offers sharp contrast between the peaks – of which the highest is Mount Olympus – and the blue waters of the Mediterranean. There are over 2,000 islands scattered across the Aegean and Ionian Seas. Greece is the cradle of Western civilisation, the origin of drama, philosophy and the birthplace of democracy. The Greece major is restricted to students who have a sound working knowledge of the Greek language. Students in the Greece major study Greek language and culture; learn about the history, politics, economics and society of contemporary Greece; and travel to Greece to study for one academic year at an institution of higher education.

Language and Culture

971710	Greek 1	8cp
972710	Greek 2	8cp
973710	Greek 3	8cp
974710	Greek 4	8cp

Contemporary Society

50140	Modernisation and Social Change	8cp
976401	Contemporary Europe	8cp

In-country Study

977710	In-country Study 1: Greece	24cp
978710	In-country Study 2: Greece	24cp

Subject descriptions

971710, 972710, 973710, 974710

Greek

Greek is offered to UTS students through arrangements with other universities in Sydney. Students in the International Studies program must have a sound working knowledge of Greek. Students are placed in classes appropriate to their level of competence. The program focuses on furthering written and oral skills in contemporary Greek and learning about literature, society and culture.

50140

Modernisation and Social Change

(Faculty of Humanities and Social Sciences)

8cp; 4hpw

The aim of this subject is to provide students with an understanding of the processes of

modernisation and social change in a comparative context using case studies in countries of Western Europe, Latin America, East and South-East Asia. The lectures will highlight a number of key issues, for example whether the processes of social change are universal or specific; the consequences of modernisation in and for the economy, politics, society, culture and ideology of non-Western societies; and whether the established Eurocentric analytical models are still useful in understanding the modern world. It will be emphasised that differing interpretations of modernisation flow from various relations of power which lead to a multiplicity of views on its meanings and significance.

976401

Contemporary Europe

8cp; 2nd semester, 5hpw

This unit is an introduction and an overview laying the groundwork for the study of contemporary Europe. It surveys present-day European Union institutions and sociopolitical developments and provides a comparative study of political and social developments in the countries of Western and Eastern Europe. It aims to provide students with an understanding of the historical background of the present-day Europe and enable them to identify major contemporary policy issues in this region of the world.

977710

In-country Study 1: Greece

24cp; prerequisite: completion of 32 credit points in Language and Culture subjects as appropriate to the student's major

978710

In-country Study 2: Greece

24cp; prerequisite: 977710 In-country Study 1: Greece

Information on In-country Study in Greece

Content and assessment

Students spend two semesters studying at an institution of higher education in Greece, through arrangements made by the Institute. The program of study focuses on the history, culture and society of Greece. Subjects to be incorporated into the program of study are negotiated in consultation with the Institute for International Studies Coordinator and the

Coordinator at the Greek institution. Students are assessed on each semester separately and assessment is based on the subjects undertaken at the host institutions, as well as project and essay work administered by the Institute for International Studies.

Costs

The two semesters of In-country Study are full-credit subjects at UTS for which HECS is payable. Students receiving Austudy in Australia are still eligible to receive it while they are engaged in a period of In-country Study in Greece. The costs of tuition in host institutions overseas and travel between Sydney and the designated host institutions are borne by UTS except in cases where a scholarship has been awarded to the student with provision for these costs. Under those circumstances, the funds that would have otherwise been allocated towards the student's tuition and travel will be redirected to support the In-country Study program in general. Students may expect that no greater costs will be incurred through undertaking a period of In-country Study in Greece than are involved in living away from home in Sydney.

The information on the program of In-country Study in Greece is correct at the time of going to press. However, the Institute for International Studies reserves the right to make alterations to the location and content of any program of In-country Study at any time.

INDONESIA MAJOR

Outline

Indonesia is Australia's closest Asian neighbour. Partly as a consequence of this, Australia's relationship with Indonesia has often been ambiguous and even at times uneasy. Indonesia's vast population and its relative accessibility make the study of Indonesian an extremely attractive option for Australian students. The Indonesian language program accepts students with varying degrees of language ability ranging from complete beginners to advanced levels. UTS is a member of the Australia Indonesia Consortium for In-country Studies, and students in the International Studies program will study in Indonesia with other students from all over Australia under its auspices.

Language and Culture

971311	Indonesian Language and Culture 1	8cp
972311	Indonesian Language and Culture 2	8cp
973311	Indonesian Language and Culture 3	8cp
974311	Indonesian Language and Culture 4	8cp

Contemporary Society

50140	Modernisation and Social Change	8cp
976301	Contemporary South-East Asia	8cp

In-country Study

977311	In-country Study 1: Indonesia	24cp
978311	In-country Study 2: Indonesia	24cp

Subject descriptions

971311, 972311, 973311, 974311

Indonesian Language and Culture

This is a language and culture program for students who are either complete beginners or who first learnt Indonesian at school in Australia. In general, there are two points of entry: the first for complete beginners and the second for students who have successfully completed HSC-level Indonesian. Students take four units in the program, usually either units 1–4 (beginners) or 3–6 (post-HSC), determined by their point of entry.

The program is organised according to a series of themes that cover a broad range of communicative situations relevant to daily social interaction in Indonesia. The focus is on the development of speaking, listening, reading and writing skills appropriate to the situations that students are likely to encounter. Vocabulary and grammar are taught using written and audiovisual materials that cover a range of themes and situations. Upon successful completion of the program, students are expected to be able to communicate about familiar things, events and opinions, and to have developed skills and strategies for continuing their learning of the language in Indonesia. Those students with prior knowledge of Indonesian entering the program at a higher level are expected to be able to communicate comfortably on a wide range of themes with the ability to adjust their language according to social variables such as formality, age and status.

In exceptional circumstances, students with an advanced working competence in Indonesian will be required to take appropriate substitute subjects, either in Contemporary Society or in another Language and Culture. For details of

substitute subjects, see the List of Approved Substitute Subjects in this handbook. Any variation in the International Studies program is subject to the approval of the Board of Studies of the Institute.

Further descriptions of each subject can be found in the Language Studies section of this handbook.

50140

Modernisation and Social Change

(Faculty of Humanities and Social Sciences)
8cp; 4hpw

The aim of this subject is to provide students with an understanding of the processes of modernisation and social change in a comparative context using case studies in countries of Western Europe, Latin America, East and South-East Asia. The lectures will highlight a number of key issues, for example whether the processes of social change are universal or specific; the consequences of modernisation in and for the economy, politics, society, culture and ideology of non-Western societies; and whether the established Eurocentric analytical models are still useful in understanding the modern world. It will be emphasised that differing interpretations of modernisation flow from various relations of power which lead to a multiplicity of views on its meanings and significance.

976301

Contemporary South-East Asia

8cp; 2nd semester, 4hpw

This subject provides an introduction to the countries of Indonesia, Malaysia and Thailand. The themes of modernity and identity will be examined at a political-economic level and also at the individual level. Issues which will be explored include migration patterns in the context of regional interrelationships; increasing urbanisation; legacies of colonialism; the commodification of culture and the growing impact of tourism; new creative forms in visual, literary and performing arts; the beliefs about and behaviour of women in the region; and ways in which religion and social practice intersect.

977311

In-country Study 1: Indonesia

24cp; prerequisite: completion of 32 credit points in Language and Culture subjects as appropriate to the student's major

978311

In-country Study 2: Indonesia

24cp; prerequisite: 977311 In-country Study 1: Indonesia

Information on In-country Study in Indonesia

Content and assessment

Students spend two consecutive semesters studying language and culture at Universitas Gadjah Mada, Yogyakarta, through arrangements made by the Institute. In the first semester the focus is on the study of language and culture. In the second semester, where possible, the study of language and culture is geared more to the professional training of the students. Students are assessed on each semester separately and assessment is based on the subjects undertaken at the host institutions, as well as project and essay work administered by the Institute for International Studies.

Location

Yogyakarta

Yogyakarta is one of the art centres of Indonesia. It is rich with an array of architectural and cultural delights, from the performing arts to visual arts and intricate crafts. It also has a rich political and social history being the site of nationalist revolutionary activity during the mid-1940s and the centre of an active Sultanate. The region is given a distinguished place by the Indonesian government, being designated as *Daerah Istimewa* (special region). The Universitas Gadjah Mada (UGM), Yogyakarta dates back to 1946, when during the turmoil of independence wars, a private foundation was established in Yogyakarta by a group of Indonesian intellectuals and nationalists under the auspices of the Sultan of Yogyakarta. Now it is one of the biggest universities in the country with more than 37,000 students and over 2,000 faculty members.

Costs

The two semesters of In-country Study are full-credit subjects at UTS for which HECS is payable. Students receiving Austudy in Australia are still eligible to receive it while they are engaged in a period of In-country Study in Indonesia. The costs of tuition in host institutions overseas and travel between Sydney and the designated host institutions are borne by UTS except in cases where a

scholarship has been awarded to the student with provision for these costs. Under those circumstances, the funds that would have otherwise been allocated towards the student's tuition and travel will be redirected to support the In-country Study program in general. Students may expect that no additional costs will be incurred through undertaking a period of In-country Study in Indonesia other than those for accommodation and maintenance.

The information on the program of In-country Study in Indonesia is correct at the time of going to press. However, the Institute for International Studies reserves the right to make alterations to the location and content of any program of In-country Study at any time.

ITALY MAJOR

Outline

Over recent decades Italy has developed from an agricultural to an industrial country, although the pace of economic growth has not been uniform throughout the country. Italy's history, culture and vibrant modern life have proved internationally attractive. The Italian major is open to students at all levels of Italian language proficiency including complete beginners.

Language and Culture

971434/5	Italian Language and Culture 1	8cp
972434/5	Italian Language and Culture 2	8cp
973434/5	Italian Language and Culture 3	8cp
974434/5	Italian Language and Culture 4	8cp

Contemporary Society

50140	Modernisation and Social Change	8cp
976401	Contemporary Europe	8cp

In-country Study

97743x	In-country Study 1: Italy	24cp
97843x	In-country Study 2: Italy	24cp

Subject descriptions

971434/5, 972434/5, 973434/5, 974434/5

Italian Language and Culture

Italian Language and Culture is offered at the UTS City campus. The program accepts beginners as well as more advanced levels. Students are placed in classes appropriate to their level of competence.

50140

Modernisation and Social Change

*(Faculty of Humanities and Social Science
8cp; 4hpw)*

The aim of this subject is to provide students with an understanding of the processes of modernisation and social change in a comparative context using case studies in countries of Western Europe, Latin America, East and South-East Asia. The lectures will highlight a number of key issues, for example whether the processes of social change are universal or specific; the consequences of modernisation in and for the economy, politics, society, culture and ideology of non-Western societies; and whether the established Eurocentric analytical models are still useful in understanding the modern world. It will be emphasised that differing interpretations of modernisation flow from various relations of power which lead to a multiplicity of views on its meanings and significance.

976401

Contemporary Europe

8cp; 2nd semester, 5hpw

This unit is an introduction and an overview laying the groundwork for the study of contemporary Europe. It surveys present-day European Union institutions and sociopolitical developments and provides a comparative study of political and social developments in the countries of Western and Eastern Europe. It aims to provide students with an understanding of the historical background of the present-day Europe and enable them to identify major contemporary policy issues in this region of the world.

97743x

In-country Study 1: Italy

24cp; prerequisite: completing of 32 credit points in Language and Culture subjects as appropriate to the student's major

97843x

In-country Study 2: Italy

24cp; prerequisite: 97743x In-country Study 1: Italy

Information on In-country Study in Italy

Content and assessment

Students spend two consecutive semesters studying language and culture either the University of Siena for Foreigners, the University of Florence or the University of Bologna, through arrangements made by the Institute. The choice of location will depend on the level of Italian language proficiency attained by each student prior to the period of In-country Study. Where possible, the study of language and culture is geared more to the professional training of the students. Students are assessed on each semester separately and assessment is based on the subjects undertaken at the host institutions, as well as project and essay work administered by the Institute for International Studies.

Locations

Siena

Located in the Tuscan countryside, Siena is one of the Italian cities which has most carefully preserved its artistic and cultural heritage. During the period of its greatest splendour, between the 13th and 16th centuries, Siena was an artistic and economic centre of considerable importance. Siena can boast a long tradition of studying and teaching Italian language: the Italian language was first taught at what is now the University of Siena for Foreigners in 1588.

Today the University of Siena for Foreigners promotes international cultural relations and offers Italian language and culture courses at all levels as well as Diploma courses for teachers and translators. It is a small university located in the old town centre a few minutes walk from the *campo*.

The study program offered to UTS students will focus on Italian language and culture and is especially suited to students who entered the UTS Italian language and culture program as beginners. Other subjects in Italian Art and History can also be undertaken, depending on levels of language proficiency.

Florence

Florence is situated in the beautiful region of Tuscany and is the cradle of the Renaissance, home of Dante, Machiavelli, Michelangelo and the Medici. It contains a wealth of art, history and culture which includes the treasures of the Uffizi Gallery and of the many richly decorated churches and palaces.

The University of Florence had its origins in the *Studium* which was established in 1321 and moved to Pisa in 1472. It was recognised as a fully fledged university in 1923 and in the academic year 1995-96, it had an enrolment of 61,583 students in 11 faculties.

The study program followed by UTS students at the University of Florence will depend on each student's level of Italian language proficiency and will include Italian language and culture classes and university subjects related to contemporary Italian society, politics, economics, art and history.

Bologna

Bologna is an elegant city, capital of the wealthy Emilia-Romagna region, famous for its cooking which is regarded as an art. It contains an extremely beautiful and intact historical centre but is also a vibrant, dynamic, modern city, one of Europe's leading industrial and commercial centres.

The University of Bologna, where teaching began in 1088, is generally recognised as being the oldest university in the Western world. Its students have included many famous artists and writers including the poets Petrarch and Dante Alighieri and its campus is housed almost exclusively in Renaissance buildings in the old centre of the city. It is one of the largest universities in Italy with almost 100,000 students.

Only students with an advanced level of Italian (similar to a native speaker) will be able to undertake their In-country Study at the University of Bologna. They will be required to undertake a test in Italian language proficiency prior to enrolment at the University of Bologna.

Students will continue their study of Italian language and culture through subjects which can be chosen from those offered by the Faculties of Political Studies and Economics. However, with the permission of the host department or faculty at the University of Bologna and the Institute for International Studies, any subject offered by the University of Bologna may be followed.

Costs

The two semesters of In-country Study are full-credit subjects at UTS for which HECS is payable. Students receiving Austudy in Australia are still eligible to receive it while they are engaged in a period of In-country Study in Italy. The costs of tuition in host institutions overseas and travel between Sydney and the designated host institutions

are borne by UTS except in cases where a scholarship has been awarded to the student with provision for these costs. Under those circumstances, the funds that would have otherwise been allocated towards the student's tuition and travel will be redirected to support the In-country Study program in general.

Students may expect that no greater costs will be incurred through undertaking a period of In-country Study in Italy than are involved in living away from home in Sydney.

The information on the program of In-country Study in Italy is correct at the time of going to press. However, the Institute for International Studies reserves the right to make alterations to the location and content of any program of In-country Study at any time.

JAPAN MAJOR

Outline

Japan is Australia's single most important trade partner and the major economic power in the Asia-Pacific region. Japan offers an obvious economic advantage to students, but its culture, history and international relations are clearly of more than passing concern. The Japanese language program has provision for both complete beginners and those who have previously studied Japanese. The cost of living in Japan is high, for that reason, entry to this major will be limited.

Language and Culture

971211	Japanese Language and Culture 1	8cp
972211	Japanese Language and Culture 2	8cp
973211	Japanese Language and Culture 3	8cp
974211	Japanese Language and Culture 4	8cp

Contemporary Society

50140	Modernisation and Social Change	8cp
976211	Contemporary Japan	8cp

In-country Study

97721x	In-country Study 1: Japan	24cp
97821x	In-country Study 2: Japan	24cp

Subject descriptions

971211, 972211, 973211, 974211

Japanese Language and Culture

This program comprises six units offered in two main streams: beginners and post-HSC. There are two main points of entry into the Japanese Language and Culture program. Students with no prior experience of the

language enter the program at Japanese 1, whilst students with HSC-level Japanese or equivalent are required to enter the program at the post-HSC level (Japanese 3). All students who have previously studied Japanese (other than at the Institute) are required to contact the Japanese Language Program Coordinator for a level assessment and placement interview.

The program enables students to develop the skills to communicate in everyday situations in order to live, study and work in a Japanese-speaking environment, or interact with Japanese people in a social, university or work-related context. The emphasis is on the development of communication skills, particularly speaking and listening, with increased focus on reading and writing skills at the post-HSC level. The study of socio-cultural aspects of Japan is an integrated and essential part of the language program. Upon successful completion of the program, students are expected to be able to communicate about familiar things, events and opinions, and to have developed skills and strategies for continuing the learning of the language in Japan. Those students with prior knowledge of Japanese entering the program at a higher level are expected to have developed an awareness of how interpersonal relations are conducted in Japan and to be able to communicate comfortably on a wide range of topics with the ability to adjust their language according to social variables such as formality, age and status.

The main approach for teaching and learning is communicative and in order for students to successfully achieve the communicative competence outcomes set for each unit, regular attendance and active participation in all class activities is essential.

In exceptional circumstances, students with an advanced working competence in Japanese will be exempted from further studying Japanese and will be required to take appropriate substitute subjects, either in Contemporary Society or in another Language and Culture. For details of substitute subjects, see the List of Approved Substitute Subjects in this handbook.

The approval of the Board of Studies of the Institute is required for any student to vary any subject of instruction in the International Studies program.

Further descriptions of each subject can be found in the Language Studies section of this handbook.

50140**Modernisation and Social Change**

(Faculty of Humanities and Social Sciences)
8cp; 4hpw

The aim of this subject is to provide students with an understanding of the processes of modernisation and social change in a comparative context using case studies in countries of Western Europe, Latin America, East and South-East Asia. The lectures will highlight a number of key issues, for example whether the processes of social change are universal or specific; the consequences of modernisation in and for the economy, politics, society, culture and ideology of non-Western societies; and whether the established Eurocentric analytical models are still useful in understanding the modern world. It will be emphasised that differing interpretations of modernisation flow from various relations of power which lead to a multiplicity of views on its meanings and significance.

976211**Contemporary Japan**

8cp; 2nd semester, 4hpw

This subject provides an introduction to the dynamics of political, social and economic systems in Modern Japan. Central themes are the causes and consequences of social change and continuity in the context of Japan's emergence as an economic superpower. In the process, it offers a general introduction to Japan's culture. This subject requires no prior knowledge of Japan or of Japanese.

97721x**In-country Study 1: Japan**

24cp; prerequisite: completion of 32 credit points in Language and Culture subjects as appropriate to the student's major

97821x**In-country Study 2: Japan**

24cp; prerequisite: 97721x In-country Study 1: Japan

Information on In-country Study in Japan

Students spend two consecutive semesters studying at one of Hokkaido University of Education at Hakodate Campus in Hokkaido, Yokohama National University at Yokohama, Yamanashi University at Kofu, Obirin

University at Machida, or Kyoto University of Foreign Studies at Kyoto. The location and content of each student's period of In-country Study in Japan are determined by the student's level of language competence in Japanese. Students who have achieved a sound working knowledge of Japanese prior to undertaking their period of In-country Study, would be able to attend classes alongside local students in a broad range of subjects. All other students will in general, devote the first semester to the study of language and culture studies. In the second semester students, depending on their acquired level of language proficiency, may choose their subjects more broadly from the university's curriculum.

Locations**Hakodate**

A tourist city located in the South of Hokkaido Island was a port between Honshu and Hokkaido. Hokkaido University of Education, located in the middle of the city of Hakodate is a national university which specialises in teacher education.

Yokohama

One of the biggest international port cities in the world, Yokohama witnessed the changes in Japan's modern history. Yokohama National University offers special Japanese culture and language programs. The university has also a Faculty of Business Administration where students with an appropriate level of language competence may be able to attend classes in their subjects.

Yamanashi

Kofu is a historic city located in Yamanashi Prefecture, one-and-half-hours by rail from Tokyo metropolitan area. Yamanashi University is a national university with two faculties, Education and Engineering.

Obirin

Machida is one of the residential satellite cities of Tokyo. Obirin is a rather small but internationalised private university. They offer special programs in the School of International Studies.

Kyoto

Kyoto was the cultural centre of Japan for about one thousand years. Kyoto University of Foreign Studies is a private university specialising in international studies.

Costs

The two semesters of In-country Study are full-credit subjects at UTS for which HECS is payable. Students receiving Austudy in Australia are still eligible to receive it while they are engaged in a period of In-country Study in Japan. The costs of tuition in host institutions overseas and travel between Sydney and the designated host institutions are borne by UTS except in cases where a scholarship has been awarded to the student with provision for these costs. Under those circumstances, the funds that would have otherwise been allocated towards the student's tuition and travel will be redirected to support the In-country Study program in general.

Other costs e.g. accommodation and food are met by students, who should be aware that the cost of living in Japan is very high and has been estimated to be the highest in the world.

The information on the program of In-country Study in Japan is correct at the time of going to press. However, the Institute for international Studies reserves the right to make alterations to the location and content of any program of In-country Study at any time.

LATIN AMERICA MAJOR

Outline

Latin America is shaping up to be the world's fastest growing region after parts of Asia. In the past the continent had a reputation for political volatility and economic crises. Now every country (apart from Cuba) has democratically elected governments. Economic reforms and moves towards regional integration are helping to create conditions for sustainable development. In historical and cultural terms the study of Latin America is highly rewarding. The region has been a 'melting pot' of European and indigenous cultures ever since the Spanish conquest in the 15th century. Beneath a complex Iberian-Latin heritage, each country has evolved separate identities expressed in popular culture and the traditions of provincial society. Geographically, the 'frontier' is still alive in Latin America – mountains, jungles, deserts, glacier regions, and humid fertile plains are all exciting accessible places for students to explore. Students attend universities in any two countries (Argentina, Chile, Mexico), spending one semester in each.

Language and Culture

971501	Spanish Language and Culture 1	8cp
972501	Spanish Language and Culture 2	8cp
973501	Spanish Language and Culture 3	8cp
974501	Spanish Language and Culture 4	8cp

Contemporary Society

50140	Modernisation and Social Change	8cp
976501	Contemporary Latin America	8cp

In-country Study

97753x	In-country Study 1: Mexico	24cp
97852x	In-country Study 2: Chile	24cp
<i>or</i>		
97753x	In-country Study 1: Mexico	24cp
97851x	In-country Study 2: Argentina	24cp
<i>or</i>		
97752x	In-country Study 1: Chile	24cp
97851x	In-country Study 2: Argentina	24cp

Subject descriptions

971501, 972501, 973501, 974501

Spanish Language and Culture

This language program is designed for students who are either complete beginners or who first learnt Spanish at school in Australia. There are two points of entry: the first for complete beginners; the second for students who have successfully completed HSC, or its equivalent. Students take four units in the program, either units 1–4 (beginners) or 3–6 (post-HSC), determined by their point of entry. Students with a language competence in Spanish that is higher than the program offered at UTS may be able to undertake further studies of Spanish at other universities in the Sydney area through arrangements made by the Institute.

The language program is organised to cover a broad range of situations relevant to daily interaction in Spanish. The focus is on the development of speaking, listening, reading and writing skills appropriate to the situations that students are likely to encounter. Vocabulary and grammar are learnt in each subject, which are centred on written and audiovisual materials encompassing a range of themes and situations.

Upon successful completion of the program, students are expected to be able to communicate about familiar things, events and opinions and to have developed skills and strategies for continuing their learning of the language in Spanish-speaking countries. Those students with prior learning of Spanish entering the program at a higher

level are expected to be able to communicate comfortably on a wide range of themes with the ability to adjust their language according to social variables such as formality, age and status. Each subject will be covered in one semester (13 weeks). There are six hours of language classes per week.

Further descriptions of each subject can be found in the Language Studies section of this handbook.

50140

Modernisation and Social Change

(Faculty of Humanities and Social Sciences)

8cp; 4hpw

The aim of this subject is to provide students with an understanding of the processes of modernisation and social change in a comparative context using case studies in countries of Western Europe, Latin America, East and South-East Asia. The lectures will highlight a number of key issues, for example whether the processes of social change are universal or specific; the consequences of modernisation in and for the economy, politics, society, culture and ideology of non-Western societies; and whether the established Eurocentric analytical models are still useful in understanding the modern world. It will be emphasised that differing interpretations of modernisation flow from various relations of power which lead to a multiplicity of views on its meanings and significance.

976501

Contemporary Latin America

8cp; 2nd semester, 4hpw

Latin America has been a crucible for social, political and economic change in the 19th and 20th centuries. Intense struggles for nationhood, democracy, economic modernisation, and secularisation, have all resonated in the countries of Latin America. During the middle of the 20th century Latin America's primary concerns were focused on national self-determination, inward industrialisation, and populist authoritarian efforts to legitimise elite rule. In the late 20th century the emphasis has shifted towards economic growth, internationalisation, and pressures to improve the capacity and accountability of governments. The unit aims to prepare students with the historical background, cultural awareness and analytic skills to interpret everyday social, political and economic reality during their period of

In-country study. The subject requires no prior knowledge of Latin America or of Spanish.

97752x or 97753x

In-country Study 1: Chile or Mexico

24cp; prerequisite: completion of 32 credit points in Language and Culture subjects as appropriate to the student's major

97851x or 97852x

In-country Study 2: Argentina or Chile

24cp; prerequisite: 97753x In-country Study 1: Mexico or 97752x In-country Study 1: Chile

Information on In-country Study in Argentina, Chile and Mexico

Content and assessment

Students spend two consecutive semesters studying language and culture at institutions of higher education in two Latin American countries through arrangements made by the Institute. The focus of study varies each semester depending on individual student preferences and the availability of subjects at host institutions. Students are assessed on each semester separately and assessment is based on the subjects undertaken at the host institutions, as well as project work administered by the Institute for International Studies.

Locations

Monterrey

Located near the US border, this is Mexico's business capital with some of the country's largest companies. Modern commercial and colonial buildings stand in contrast to each other. The Instituto Tecnológico de Estudios Superiores de Monterrey (ITESM) has an international reputation. It is well known for its technological facilities, Business Administration courses, and a large international exchange program.

Concepción

Concepción is a medium-sized coastal city in Chile, south of the capital, Santiago. It is surrounded by forests and fishing villages, with easy access to the lake district, mountains, and Mapuche Indian territories. The university is the third largest in Chile with a wide range of excellent faculties. The picturesque campus near the town centre houses an important museum of Chilean art.

Córdoba

An historic city in the centre of Argentina close to hills and pampa. It is known for its universities, colonial architecture, cultural life, the country's car industry, and lively politics. The Universidad Nacional de Córdoba is Argentina's oldest, founded in 1613. It is still one of the country's best and largest universities with an extensive range of faculties and subject areas.

Costs

The two semesters of In-country Study are full-credit subjects at UTS for which HECS is payable. Students receiving Austudy in Australia are still eligible to receive it while they are engaged in a period of In-country Study in Argentina, Chile or Mexico. The costs of tuition in host institutions overseas and travel between Sydney and the designated host institutions are borne by UTS except in cases where a scholarship has been awarded to the student with provision for these costs. Under those circumstances, the funds that would have otherwise been allocated toward the student's tuition and travel will be redirected to support the In-country Study program in general. Because of the adjustment from one country to another students may find that their costs are slightly higher than the cost of living away from home for one year in Sydney.

The information on the program of In-country Study in Latin America is correct at the time of going to press. However, the Institute for International Studies reserves the right to make alterations to the location and content of any program of In-country Study at any time.

MALAYSIA MAJOR

Outline

Malaysia is a major force in South-East Asia. In economic terms its growth over recent years has stimulated international interest. Its close proximity to Australia makes the study of Malaysia and Malaysian particularly relevant. The Malaysian language and culture program concentrates on the training of students who are either complete beginners or have a basic knowledge of Malaysian through previous experience or study. Students in the International Studies program may study in Malaysia for a full academic year within this major, or spend one semester in Malaysia as part of a South-East Asia major.

Language and Culture

971331	Malaysian Language and Culture 1	8cp
972331	Malaysian Language and Culture 2	8cp
973331	Malaysian Language and Culture 3	8cp
974331	Malaysian Language and Culture 4	8cp

Contemporary Society

50140	Modernisation and Social Change	8cp
976301	Contemporary South-East Asia	8cp

In-country Study

97733x	In-country Study 1: Malaysia	24cp
97833x	In-country Study 2: Malaysia	24cp

Subject descriptions

971331, 972331, 973331, 974331

Malaysian Language and Culture

This is a language and culture program for students who intend to study Malaysian as part of a combined degree through the Institute for International Studies or as an elective for credit within their current degree. In general, there are two points of entry: the first for complete beginners, the second for students who have a basic knowledge of Malaysian through previous experience or study. Students take four units in the program, usually either units 1-4 (beginners) or 3-6 (students with previous knowledge), determined by their point of entry.

The program is organised according to a series of themes that cover a broad range of communicative situations relevant to daily interaction in Malaysia. The focus is on the development of speaking, listening, reading and writing skills appropriate to the situations that students are likely to encounter. Vocabulary and grammar are learnt within the context of the course content, which is centred on written and audiovisual materials encompassing a range of themes and situations. Upon successful completion of the program, students are expected to be able to communicate about familiar things, events and opinions and to have developed skills and strategies for continuing their learning of the language in Malaysia. Those students with prior knowledge of Malaysian entering the program at a higher level are expected to communicate comfortably on a wide range of themes with the ability to adjust their language according to social variables such as formality, age and status.

Due to the recognised similarities between Malaysian and Indonesian, the language and culture programs units 1-3 will cover the

structures and functions common to both languages while identifying the differentiating features in terms of vocabulary and grammar. Essentially, two streams will be created and each group will have access to authentic material. Malaysian units 4–6 will be conducted separately and will focus on the study of Malaysian at an advanced level.

In exceptional circumstances, students with advanced competence in Malaysian will be excluded from this language and culture program, and be required to substitute other appropriate units from a list of approved subjects or units. These units may be other units on offer in the International Studies program, including those related to the study of Contemporary Society, or those concerned with the study of another language and culture. The approval of the Board of Studies of the Institute is required for any student to vary any subject of instruction in the International Studies program.

Further descriptions of each subject can be found in the Language Studies section of this handbook.

50140

Modernisation and Social Change

(Faculty of Humanities and Social Sciences)

8cp; 4hpw

The aim of this subject is to provide students with an understanding of the processes of modernisation and social change in a comparative context using case studies in countries of Western Europe, Latin America, East and South-East Asia. The lectures will highlight a number of key issues, for example whether the processes of social change are universal or specific; the consequences of modernisation in and for the economy, politics, society, culture and ideology of non-Western societies; and whether the established Eurocentric analytical models are still useful in understanding the modern world. It will be emphasised that differing interpretations of modernisation flow from various relations of power which lead to a multiplicity of views on its meanings and significance.

976301

Contemporary South-East Asia

8cp; 2nd semester, 4hpw

This subject provides an introduction to the countries of Indonesia, Malaysia and Thailand. The themes of modernity and identity will be examined at a political-economic level and also

at the individual level. Issues which will be explored include migration patterns in the context of regional interrelationships; increasing urbanisation; legacies of colonialism; the commodification of culture and the growing impact of tourism; new creative forms in the visual, literary and performing arts; the beliefs about and behaviour of women in the region; and ways in which religion and social practice intersect.

97733x

In-country Study 1: Malaysia

24cp; prerequisite: completion of 32 credit points in Language and Culture subjects as appropriate to the student's major

97833x

In-country Study 2: Malaysia

24cp; prerequisite: 97733x In-country Study 1: Malaysia

Information on In-country Study in Malaysia

Content and assessment

Students may opt to spend their first semester at Universiti Malaysia Sarawak near Kuching in East Malaysia, and their second semester at Universiti Sains Malaysia in Penang in West Malaysia. Alternatively, they may spend two consecutive semesters of study on language and culture at Universiti Sains Malaysia, Penang. These arrangements will be made by the Institute. The first semester in Sarawak will consist of a field-based program with the Faculty of Resource Science and Technology. The second semester in Penang will consist of a program of language and culture studies. Students are assessed on each semester separately, with assessment based on courses followed at the host institution, project and essay work administered by the Institute for International Studies.

Locations

Penang

Penang was the first of the Straits Settlements – areas in which the British set up their empire trading outposts in the 18th century. It is now a bustling economic and tourist centre with some of the largest semi-conductor factories in the world and a plethora of high-rise hotels along the northern beaches. The Universiti Sains Malaysia (USM), Penang was established as the second university in the country in 1969. It was first known as Universiti Pulau Pinang.

In 1971, it took over the former military camp at Minden, a 239.4-hectare site which is about 10 kilometres south of the city of Georgetown. The student population has expanded rapidly and is now almost 19,000. Further expansion saw the setting up of two branch campuses at Kubang Kerian, Kelantan and Tronoh, Perak; the former houses the medical school and University Hospital while the latter houses the existing five engineering schools.

Sarawak

Sarawak is the largest state in Malaysia – 124,000 square kilometres. It lies in the northwest of the island of Borneo and along with neighbouring Sabah, makes up east Malaysia. Sarawak was under the loose control of the sultanate of Brunei from the 15th to the early 19th century. An English adventurer, James Brooke, arrived in what is now the capital, Kuching in 1839 and subsequently became the first of the ‘white rajahs’. The ‘white rajahs’ ruled until the World War II, after which Sarawak formally became a British colony. It became part of Malaysia in 1963 and now shows signs of rapid development and further integration into the global economy.

Costs

The two semesters of In-country Study are full-credit subjects at UTS for which HECS is payable. Students receiving Austudy in Australia are still eligible to receive it while they are engaged in a period of In-country Study in Malaysia. The costs of tuition in host institutions overseas and travel between Sydney and the designated host institutions are borne by UTS except in cases where a scholarship has been awarded to the student with provision for these costs. Under those circumstances, the funds that would have otherwise been allocated towards the student’s tuition and travel will be redirected to support the In-country Study program in general. Students may expect that no greater costs will be incurred through undertaking a period of In-country Study in Malaysia than are involved in living away from home in Sydney.

The information on the program of In-country Study in Malaysia is correct at the time of going to press. However, the Institute for International Studies reserves the right to make alterations to the location and content of any program of In-country Study at any time.

MEXICO MAJOR

Outline

Mexico’s geographic position between the United States and Latin America, gives the country special characteristics. Its predominantly Indian and ‘mestizo’ population maintains strong native and Catholic traditions. Mexico’s national consciousness is also shaped by its difficult relationship with the United States, and a deep ambivalence about North American culture. The continuous migration of Mexican workers, establishment of export-processing zones along the northern border, and the recent NAFTA free trade agreement all provide opportunities for integration with the world’s largest economy. Political events dominate the late 1990s as the one-party system, in place since the Mexican Revolution, yields to democratic pressures. Among Mexico’s great attractions are its outstanding examples of pre-colonial, Iberian-Latin, and traditional popular culture in, for example, architecture, music, and art.

Language and Culture

971501	Spanish Language and Culture 1	8cp
972501	Spanish Language and Culture 2	8cp
973501	Spanish Language and Culture 3	8cp
974501	Spanish Language and Culture 4	8cp

Contemporary Society

50140	Modernisation and Social Change	8cp
976501	Contemporary Latin America	8cp

In-country Study

977531	In-country Study 1: Mexico	24cp
978531	In-country Study 2: Mexico	24cp

Subject descriptions

971501, 972501, 973501, 974501

Spanish Language and Culture

This language program is designed for students who are either complete beginners or who first learnt Spanish at school in Australia. There are two points of entry: the first for complete beginners; the second for students who have successfully completed HSC, or its equivalent. Students take four units in the program, either units 1–4 (beginners) or 3–6 (post-HSC), determined by their point of entry. Students with a language competence in Spanish that is higher than the program offered

at UTS may be able to undertake further studies of Spanish at other universities in the Sydney area through arrangements made by the Institute.

The language program is organised to cover a broad range of situations relevant to daily interaction in Spanish. The focus is on the development of speaking, listening, reading and writing skills appropriate to the situations that students are likely to encounter. Vocabulary and grammar are learnt in each subject, which are centred on written and audiovisual materials encompassing a range of themes and situations.

Upon successful completion of the program, students would be expected to be able to communicate about familiar things, events and opinions and to have developed skills and strategies for continuing their learning of the language in Spanish-speaking countries. Those students with prior learning of Spanish entering the program at higher level would be expected to be able to communicate comfortably on a wide range of themes with the ability to adjust their language according to social variables such as formality, age and status. Each subject will be covered in one semester (13 weeks). There are six hours of language classes per week.

Further descriptions of each subject can be found in the Language Studies section of this handbook.

50140

Modernisation and Social Change

(Faculty of Humanities and Social Sciences)

8cp; 4hpw

The aim of this subject is to provide students with an understanding of the processes of modernisation and social change in a comparative context using case studies in countries of Western Europe, Latin America, East and South-East Asia. The lectures will highlight a number of key issues, for example whether the processes of social change are universal or specific; the consequences of modernisation in and for the economy, politics, society, culture and ideology of non-Western societies; and whether the established Eurocentric analytical models are still useful in understanding the modern world. It will be emphasised that differing interpretations of modernisation flow from various relations of power which lead to a multiplicity of views on its meanings and significance.

976501

Contemporary Latin America

8cp; 2nd semester, 4hpw

Latin America has been a crucible for social, political and economic change in the 19th and 20th centuries. Intense struggles for nationhood, democracy, economic modernisation, and secularisation, have all resonated in the countries of Latin America. During the middle of the 20th century Latin America's primary concerns were focused on national self-determination, inward industrialisation, and populist authoritarian efforts to legitimise elite rule. In the late 20th century the emphasis has shifted towards economic growth, internationalisation, and pressures to improve the capacity and accountability of governments. The unit aims to prepare students with the historical background, cultural awareness and analytic skills to interpret everyday social, political and economic reality during their period of In-country Study. The subject requires no prior knowledge of Latin America or of Spanish.

97753x

In-country Study 1: Mexico

24cp; prerequisite: completion of 32 credit points in Language and Culture subjects as appropriate to the student's major

97853x

In-country Study 2: Mexico

24cp; prerequisite: 97753x In-country Study 1: Mexico

Information on In-country Study in Mexico

Content and assessment

Students spend two consecutive semesters studying social science or culture and humanities subjects at an institution of higher education in Mexico through arrangements made by the Institute. The focus of study varies each semester depending on individual student preferences and the availability of subjects at host institutions. Students are assessed on each semester separately and assessment is based on the subjects undertaken at the host institutions, as well as project work administered by the Institute for International Studies.

Location

Monterrey

Located near the US border, this is Mexico's business capital with some of the country's largest companies. Modern commercial and colonial buildings stand in contrast to each other. The Instituto Tecnológico de Estudios Superiores de Monterrey (ITESM) has an international reputation. It is well known for its technological facilities, Business Administration courses, and a large international exchange program. ITESM also has campuses in other parts of Mexico which students may move to in the second semester.

Costs

The two semesters of In-country Study are full-credit subjects at UTS for which HECS is payable. Students receiving Austudy in Australia are still eligible to receive it while they are engaged in a period of In-country Study in Mexico. The costs of tuition in host institutions overseas and travel between Sydney and the designated host institutions are borne by UTS except in cases where a scholarship has been awarded to the student with provision for these costs. Under those circumstances, the funds that would have otherwise been allocated towards the student's tuition and travel will be redirected to support the In-country Study program in general. Other costs e.g. accommodation and food are met by students who may expect that no greater costs will be incurred through undertaking a period of In-country Study in Mexico than are involved in living away from home in Sydney.

The information on the program of In-country Study in Mexico is correct at the time of going to press. However, the Institute for International Studies reserves the right to make alterations to the location and content of any program of In-country Study at any time.

POLAND MAJOR

Outline

Modern Poland played a leading role in the rise of democracy throughout Eastern Europe. Its highlights include Warsaw, the centre of the country's economic revitalisation, now restored to its pre-World War II splendour; Gdansk, where a series of shipyard strikes gave birth to the Solidarity movement, led by Lech Walesa; and Cracow, long ago Poland's capital and renowned for its historical monuments. The Poland major is restricted to students who have a sound working knowledge of the Polish language. Students in the Poland major study Polish language and culture; learn about the history, politics, economics and society of contemporary Poland; and travel to Poland to study for one academic year at an institution of higher education.

Language and Culture

97174	Polish 1	8cp
972764	Polish 2	8cp
973764	Polish 3	8cp
974764	Polish 4	8cp

Contemporary Society

50140	Modernisation and Social Change	8cp
976401	Contemporary Europe	8cp

In-country Study

977761	In-country Study 1: Poland	24cp
978761	In-country Study 2: Poland	24cp

Subject descriptions

971764, 972764, 973764, 974764

Polish

Polish is offered to UTS students through an arrangement with Macquarie University. Students in the International Studies program must have a sound working knowledge of Polish. Students are placed in classes appropriate to their level of competence. The Polish language program allows students to improve their linguistic competence through practice in speaking and writing skills while consolidating their previous knowledge of grammar.

50140**Modernisation and Social Change***(Faculty of Humanities and Social Sciences)**8cp; 4hpw*

The aim of this subject is to provide students with an understanding of the processes of modernisation and social change in a comparative context using case studies in countries of Western Europe, Latin America, East and South-East Asia. The lectures will highlight a number of key issues, for example whether the processes of social change are universal or specific; the consequences of modernisation in and for the economy, politics, society, culture and ideology of non-Western societies; and whether the established Eurocentric analytical models are still useful in understanding the modern world. It will be emphasised that differing interpretations of modernisation flow from various relations of power which lead to a multiplicity of views on its meanings and significance.

976401**Contemporary Europe***8cp; 2nd semester, 5hpw*

This unit is an introduction and an overview laying the groundwork for the study of contemporary Europe. It surveys present-day European Union institutions and sociopolitical developments and provides a comparative study of political and social developments in the countries of Western and Eastern Europe. It aims to provide students with an understanding of the historical background of the present-day Europe and enable them to identify major contemporary policy issues in this region of the world.

977761**In-country Study 1: Poland**

24cp; prerequisite: completion of 32 credit points in Language and Culture subjects as appropriate to the student's major.

978761**In-country Study 2: Poland**

24cp; prerequisite: 977761 In-country Study 1: Poland

Information on In-country Study in Poland**Content and assessment**

Students spend two consecutive semesters studying in the Institute of Political Science at the University of Warsaw, through arrangements made by the Institute. Programs of study designed to enhance students' understanding of Polish history, culture and society are negotiated in consultation with the Institute for International Studies Coordinator and the Director of the Institute of Political Science. Students are assessed on each semester separately and assessment is based on the subjects undertaken at the host institutions, as well as project work administered by the Institute for International Studies.

Costs

The two semesters of In-country Study are full-credit subjects at UTS for which HECS is payable. Students receiving Austudy in Australia are still eligible to receive it while they are engaged in a period of In-country Study in Poland. The costs of tuition in host institutions overseas and travel between Sydney and the designated host institutions are borne by UTS except in cases where a scholarship has been awarded to the student with provision for these costs. Under those circumstances, the funds that would have otherwise been allocated towards the student's tuition and travel will be redirected to support the In-country Study program in general. Students may expect that no greater costs will be incurred through undertaking a period of In-country Study in Poland than are involved in living away from home in Sydney.

The information on the program of In-country Study in Poland is correct at the time of going to press. However, the Institute for International Studies reserves the right to make alterations to the location and content of any program of In-country Study at any time.

RUSSIA MAJOR

Outline

Russia is a country of astonishing resources. The two main cities are Moscow, in the country's historic heartland at the centre of European Russia, and St Petersburg, established 300 years ago as Russia's gateway to Europe. In these two places the tsars reigned and the world's greatest communist state was born. Recent developments in Russian politics have resulted in dramatic changes in Russia. The Russia major accepts beginners as well as more advanced levels. Students in the Russia major study Russian language and culture; learn about the history, politics, economics and society of contemporary Russia; and travel to Russia to study for one academic year at an institution of higher education.

Language and Culture

971734 Russian 1	8cp
972734 Russian 2	8cp
973734 Russian 3	8cp
974734 Russian 4	8cp

Contemporary Society

50140 Modernisation and Social Change	8cp
976401 Contemporary Europe	8cp

In-country Study

977731 In-country Study 1: Russia	24cp
978731 In-country Study 2: Russia	24cp

Subject descriptions

971734, 972734, 973734, 974734

Russian

Russian is offered to UTS students through an arrangement with Macquarie University. The program accepts beginners as well as more advanced levels. Students are placed in classes appropriate to their level of competence.

50140

Modernisation and Social Change

(Faculty of Humanities and Social Sciences)

8cp; 4hpw

The aim of this subject is to provide students with an understanding of the processes of modernisation and social change in a comparative context using case studies in countries of Western Europe, Latin America, East and South-East Asia. The lectures will highlight a number of key issues, for example whether the processes of social change are

universal or specific; the consequences of modernisation in and for the economy, politics, society, culture and ideology of non-Western societies; and whether the established Eurocentric analytical models are still useful in understanding the modern world. It will be emphasised that differing interpretations of modernisation flow from various relations of power which lead to a multiplicity of views on its meanings and significance.

976401

Contemporary Europe

8cp; 2nd semester, 5hpw

This unit is an introduction and an overview laying the groundwork for the study of contemporary Europe. It surveys present-day European Union institutions and sociopolitical developments and provides a comparative study of political and social developments in the countries of Western and Eastern Europe. It aims to provide students with an understanding of the historical background of the present-day Europe and enable them to identify major contemporary policy issues in this region of the world.

977731

In-country Study 1: Russia

24cp; prerequisite: completion of 32 credit points in Language and Culture subjects as appropriate to the student's major

978731

In-country Study 2: Russia

24cp; prerequisite: 977731 In-country Study 1: Russia

Information on In-country Study in Russia

Content and assessment

Students spend two consecutive semesters studying language and culture at St Petersburg State Technical University in Russia through arrangements made by the Institute. In the first semester the focus is on the study of language and culture. In the second semester, where possible, the study of language and culture is geared more to the professional training of the students. Students are assessed on each semester separately and assessment is based on the subjects undertaken at the host institutions, as well as project and essay work administered by the Institute for International Studies.

Costs

The two semesters of In-country Study are full-credit subjects at UTS for which HECS is payable. Students receiving Austudy in Australia are still eligible to receive it while they are engaged in a period of In-country Study in Russia. The costs of tuition in host institutions overseas and travel between Sydney and the designated host institutions are borne by UTS except in cases where a scholarship has been awarded to the student with provision for these costs. Under those circumstances, the funds that would have otherwise been allocated towards the student's tuition and travel will be redirected to support the In-country Study program in general. Students may expect that no greater costs will be incurred through undertaking a period of In-country Study in Russia than are involved in living away from home in Sydney.

The information on the program of In-country Study in Russia is correct at the time of going to press. However, the Institute for International Studies reserves the right to make alterations to the location and content of any program of In-country Study at any time.

SLOVENIA MAJOR

Outline

Slovenia is the meeting point of three European worlds – the Mediterranean, Alpine and Pannonian. It is not only one of the youngest, but also one of the smallest European countries with only two million inhabitants. Along the foothills of the Eastern end of the chain of Alps, at the very tip of the most northerly Mediterranean bay, it is a natural hub of European routes from north to south and west to east. Entry to the Slovenia major is restricted to students who have a sound working knowledge of the Slovenian language. Students in the Slovenia major study Slovenian language and culture; learn about the history, politics, economics and society of contemporary Slovenia; and travel to Slovenia to study for one academic year at an institution of higher education.

Language and Culture

971754 Slovenian 1	8cp
972754 Slovenian 2	8cp
973754 Slovenian 3	8cp
974754 Slovenian 4	8cp

Contemporary Society

50140 Modernisation and Social Change	8cp
976401 Contemporary Europe	8cp

In-country Study

977750 In-country Study 1: Slovenia	24cp
978750 In-country Study 2: Slovenia	24cp

Subject descriptions

971754, 972754, 973754, 974754

Slovenian

Slovenian is offered to UTS students through an arrangement with Macquarie University. Students in the International Studies program must have a sound working knowledge of Slovenian. Students are placed in classes appropriate to their level of competence. The aim of the Slovenian language program is to enhance students' communicative competence with particular emphasis being placed in broadening their vocabulary and grammar.

50140

Modernisation and Social Change

(Faculty of Humanities and Social Sciences)

8cp; 4hpw

The aim of this subject is to provide students with an understanding of the processes of modernisation and social change in a comparative context using case studies in countries of Western Europe, Latin America, East and South-East Asia. The lectures will highlight a number of key issues, for example whether the processes of social change are universal or specific; the consequences of modernisation in and for the economy, politics, society, culture and ideology of non-Western societies; and whether the established Eurocentric analytical models are still useful in understanding the modern world. It will be emphasised that differing interpretations of modernisation flow from various relations of power which lead to a multiplicity of views on its meanings and significance.

976401

Contemporary Europe

8cp; 2nd semester, 5hpw

This unit is an introduction and an overview laying the groundwork for the study of contemporary Europe. It surveys present-day European Union institutions and sociopolitical developments and provides a comparative study of political and social developments in the countries of Western and Eastern Europe.

It aims to provide students with an understanding of the historical background of the present-day Europe and enable them to identify major contemporary policy issues in this region of the world.

977750

In-country Study 1: Slovenia

24cp; prerequisite: completion of 32 credit points in Language and Culture subjects as appropriate to the student's major

978750

In-country Study 2: Slovenia

24cp; prerequisite: 977750 In-country Study 1: Slovenia

Information on In-country Study in Slovenia

Content and assessment

Students spend two semesters studying at an institution of higher education in Slovenia, through arrangements made by the Institute. The program of study focuses on the history, culture and society of Slovenia. Subjects to be incorporated into the program of study are negotiated in consultation with the Institute for International Studies Coordinator and the Coordinator at the Slovenian institution. Students are assessed on each semester separately and assessment is based on the subjects undertaken at the host institutions, as well as project and essay work administered by the Institute for International Studies.

Costs

The two semesters of In-country Study are full-credit subjects at UTS for which HECS is payable. Students receiving Austudy in Australia are still eligible to receive it while they are engaged in a period of In-country Study in Slovenia. The costs of tuition in host institutions overseas and travel between Sydney and the designated host institutions are borne by UTS except in cases where a scholarship has been awarded to the student with provision for these costs. Under those circumstances, the funds that would have otherwise been allocated towards the student's tuition and travel will be redirected to support the In-country Study program in general. Students may expect that no greater costs will be incurred through undertaking a period of In-country Study in Slovenia than are involved in living away from home in Sydney.

The information on the program of In-country Study in Slovenia is correct at the time of going to press. However, the Institute for International Studies reserves the right to make alterations to the location and content of any program of In-country Study at any time.

SOUTH CHINA MAJOR

Outline

Since the late 1980s, Hong Kong, Guangdong and Hainan – and their interaction – have become increasingly important in the economic and political geography of East Asia. The economic integration of Hong Kong and Guangdong has been a major factor in the dramatic economic growth of the People's Republic of China since 1989. With the incorporation of Hong Kong into the People's Republic of China, the political dimensions of the relationship between Hongkong and Guangdong have grown in importance. Hainan's establishment as a province and special economic zone of the People's Republic of China has also dramatically altered its economic prospects.

Paradoxically, South China has played a significant but often unrecognised part in the history of Australia, and particularly of Sydney and New South Wales. Migrants from Guangdong first started to arrive in the 1850s and provided the foundations of one of Australia's largest ethnic communities. More recently, in the 1980s and 1990s there has been significant migration from South China and South Chinese communities in East Asia and South-East Asia.

Students in the South China major study Cantonese language and culture; learn about the history, politics, economics and society of contemporary South China; and travel to both Hong Kong and Guangdong for one semester of study.

Language and Culture

971121	Cantonese Language and Culture 1	8cp
972121	Cantonese Language and Culture 2	8cp
973121	Cantonese Language and Culture 3	8cp
974121	Cantonese Language and Culture 4	8cp

Contemporary Society

50140	Modernisation and Social Change	8cp
976101	Chinese East Asia	8cp

In-country Study

97712x	In-country Study 1: Guangdong or Hong Kong	24cp
97812x	In-country Study 2: Guangdong or Hong Kong	24cp

Subject descriptions**971121, 972121, 973121, 974121****Cantonese Language and Culture****Cantonese Language and Culture A**

Cantonese A is a four-subject language program for students who are complete beginners.¹ The program aims at developing the students' basic communicative competence and linguistic skills in general social interactions where Cantonese is used. It also deals with Chinese characters and other features of Cantonese discourse. The teaching incorporates an introduction to Cantonese culture and helps students to appreciate the wider cultural ramifications of Cantonese in various contexts. The course is organised around communicative and functional themes so that students can learn the language in relevant social situations.

Each subject will be covered in one semester (13 weeks). There are six hours of language classes plus a one-hour session of language laboratory work per week. The teaching approach adopted is 'communicative' and students are expected to participate actively in all classroom activities to maximise the acquisition of language skills.

Further descriptions of each subject can be found in the Language Studies section of this handbook.

¹ In general, students who speak another Chinese language, and who have achieved a high proficiency in reading and writing Chinese are advised to take Cantonese B, which is a two-subject language program specifically designed to improve students' oral and aural skills in Cantonese.

Cantonese Language and Culture B

Cantonese B is a two-subject language program for students who speak at least one Chinese language other than Cantonese and have achieved a high proficiency in Chinese writing. The program is specifically designed to improve students' oral and listening skills in Cantonese and to provide them with the necessary linguistic competence for a period of study and work in South China. It will also provide students with the basic foundation and skills which are necessary to continue their learning of Cantonese.

Each subject in the program consists of 52 hours of classroom instruction, involving many interactive group and pair-work activities. Language items (such as vocabulary and phonological features) related to the communication goals, and socio-cultural items (such as kinships and different socio-cultural contexts) related to the socio-cultural goals will receive equal importance. Audiovisual equipment and computers will be used to facilitate the teaching and learning of the language. The teaching approach adopted is 'communicative' and students are expected to participate fully in all classroom activities in the process of acquiring language skills.

The course is organised around themes and topics so that students learn Cantonese in relevant social situations. The program incorporates an introduction to Cantonese culture and helps students to appreciate the wider cultural ramifications of Cantonese in various contexts.

Further descriptions of each subject can be found in the Language Studies section of this handbook.

50140**Modernisation and Social Change**

(Faculty of Humanities and Social Sciences)
8cp; 4hpw

The aim of this subject is to provide students with an understanding of the processes of modernisation and social change in a comparative context using case studies in countries of Western Europe, Latin America, East and South-East Asia. The lectures will highlight a number of key issues, for example whether the processes of social change are universal or specific; the consequences of modernisation in and for the economy, politics, society, culture and ideology of non-Western societies; and whether the established Eurocentric analytical models are still useful in understanding the modern world. It will be emphasised that differing interpretations of modernisation flow from various relations of power which lead to a multiplicity of views on its meanings and significance.

976101**Chinese East Asia**

8cp; 2nd semester, 4hpw

South China – Hong Kong, Taiwan and the Southern Chinese provinces of Fujian and Guangdong – is a region of global importance. It is a dynamo of economic growth for the East

Asia region that has grown out of the economic integration of Hong Kong, Taiwan and South China, and is now expanding to include East China. Yet its constituent parts have developed separately in different and often inimical political systems. As a result of all of these factors, South China is likely to be of increasing importance strategically, economically and politically. This subject examines the development of Hong Kong, Taiwan and South China and their interaction. It is an introductory subject that requires no prior knowledge of the region or of any Chinese language.

97712x

In-country Study 1: Guangdong or Hong Kong

24cp; prerequisite: completion of 32 credit points in Language and Culture subjects as appropriate to the student's major

97812x

In-country Study 2: Guangdong or Hong Kong

24cp; prerequisite: 97712x In-country Study 1: Guangdong or Hong Kong

Information on In-country Study in Guangdong and Hong Kong

Content and assessment

Students spend two consecutive semesters studying language and culture at institutions of higher education in South China through arrangements made by the Institute. They spend one semester at Zhongshan University, Guangzhou and another at the Hong Kong University of Science and Technology. In the first semester the focus is on the study of language and culture. In the second semester, where possible, the study of language and culture is geared more to the professional training of the students. Students are assessed on each semester separately and assessment is based on the subjects undertaken at the host institutions, as well as project and essay work administered by the Institute for International Studies.

Locations

Hong Kong and Guangzhou

Hong Kong is situated on the south-eastern tip of China. It is a small but very dynamic territory which has earned an international reputation as a leading manufacturing, commercial, financial and communications centre. Crossed by the Pearl River, Guangzhou is the capital of Guangdong Province, the largest metropolis in South China's coastal area, and China's southern gateway since ancient times. It is green all year around and is also known as a city of flowers for its tree-lined and flower decorated streets. Both cities have a subtropical climate. The Hong Kong University of Science and Technology (HKUST) is a world-class technological university. Zhongshan University is one of the top universities in China.

Costs

The two semesters of In-country Study are full-credit subjects at UTS for which HECS is payable. Students receiving Austudy in Australia are still eligible to receive it while they are engaged in a period of In-country Study in South China. The costs of tuition in host institutions overseas and travel between Sydney and the designated host institutions are borne by UTS except in cases where a scholarship has been awarded to the student with provision for these costs. Under those circumstances, the funds that would have otherwise been allocated towards the student's tuition and travel will be redirected to support the In-country Study program in general. Students should be aware that the cost of living in Hong Kong is higher than in Sydney.

The information on the program of In-country Study in South China is correct at the time of going to press. However, the Institute for International Studies reserves the right to make alterations to the location and content of any program of In-country Study at any time.

SOUTH-EAST ASIA MAJOR

Outline

Malaysia and Indonesia are Australia's closest Asian neighbours. Partly in consequence, Australia's relationships with these two countries have often been ambiguous and even at times uneasy. Their vast population and the relative ease of access for Australian students make their study extremely attractive. The Indonesian and Malaysian language programs concentrate on the training of students who are either complete beginners or have a basic knowledge of Malaysian or Indonesian through previous experience or study. UTS is a member of the Australia Indonesia Consortium for In-country Studies, and, under its auspices, students in the International Studies program may study in Indonesia with other students from all over Australia, as well as in Malaysia.

Language and Culture

971311	Indonesian Language and Culture 1	8cp
	<i>or</i>	
971331	Malaysian Language and Culture 1	8cp
972311	Indonesian Language and Culture 2	8cp
	<i>or</i>	
972331	Malaysian Language and Culture 2	8cp
973311	Indonesian Language and Culture 3	8cp
	<i>or</i>	
973331	Malaysian Language and Culture 3	8cp
974311	Indonesian Language and Culture 4	8cp
	<i>or</i>	
974331	Malaysian Language and Culture 4	8cp

Contemporary Society

50140	Modernisation and Social Change	8cp
976301	Contemporary South-East Asia	8cp

In-country Study

97731x	In-country Study 1: Indonesia	24cp
97833x	In-country Study 2: Malaysia	24cp

Subject descriptions

971311, 972311, 973311, 974311

Indonesian Language and Culture

This is a language and culture program for students who are either complete beginners or who first learnt Indonesian at school in Australia. In general, there are two points of entry: the first for complete beginners and the second for students who have successfully

completed HSC-level Indonesian. Students take four units in the program, usually either units 1–4 (beginners) or 3–6 (post-HSC), determined by their point of entry.

The program is organised according to a series of themes that cover a broad range of communicative situations relevant to daily social interaction in Indonesia. The focus is on the development of speaking, listening, reading and writing skills appropriate to the situational contexts that students are likely to encounter. Vocabulary and grammar are taught using written and audiovisual materials that cover a range of themes and situations. Upon successful completion of the program, students are expected to be able to communicate about familiar things, events and opinions, and to have developed skills and strategies for continuing their learning of the language in Indonesia. Those students with prior knowledge of Indonesian entering the program at a higher level are expected to be able to communicate comfortably on a wide range of themes with the ability to adjust their language appropriately according to considerations of social variables such as formality, age and status.

In exceptional circumstances, students with an advanced working competence in Indonesian will be exempted from further studying Indonesian and will be required to take appropriate substitute subjects: either in Contemporary Society or in another Language and Culture. For details of substitute subjects, see the List of Approved Substitute Subjects in this handbook. Any variation in the International Studies program is subject to the approval of the Board of Studies of the Institute.

971331, 972331, 973331, 974331

Malaysian Language and Culture

This is a language and culture program for students who intend to study Malaysian as part of a combined degree through the Institute for International Studies or as an elective for credit within their current degree. In general, there are two points of entry: the first for complete beginners, the second for students who have a basic knowledge of Malaysian through previous experience or study. Students take four units in the program, usually either units 1–4 (beginners) or 3–6 (students with previous knowledge), determined by their point of entry.

The program is organised according to a series of themes that cover a broad range of

communicative situations relevant to daily interaction in Malaysia. The focus is on the development of speaking, listening, reading and writing skills appropriate to the situational contexts that students are likely to encounter. Vocabulary and grammar are learnt within the context of the course content, which is centred on written and audiovisual materials encompassing a range of themes and situations. Upon successful completion of the program, students are expected to be able to communicate about familiar things, events and opinions and to have developed skills and strategies for continuing their learning of the language in Malaysia. Those students with prior knowledge of Malaysian entering the program at a higher level are expected to communicate comfortably on a wide range of themes with the ability to adjust their language appropriately according to considerations of social variables such as formality, age and status.

Due to the recognised similarities between Malaysian and Indonesian the language and culture programs units 1–3 will cover the structures and functions common to both languages while identifying the differentiating features in terms of vocabulary and grammar. Essentially two streams will be created and each group will have access to authentic material. Malaysian units 4–6 will be conducted separately and will focus on the study of Malaysian at an advanced level.

In exceptional circumstances, students with advanced competence in Malaysian will be excluded from this language and culture program, and required to substitute other appropriate units from a list of approved subjects or units. These units may be other units on offer in the International Studies program, including those related to the study of Contemporary Society, or those concerned with the study of another language and culture. The approval of the Board of Studies of the Institute is required for any student to vary any subject of instruction in the International Studies program.

50140

Modernisation and Social Change

(Faculty of Humanities and Social Sciences)
8cp; 4hpw

The aim of this subject is to provide students with an understanding of the processes of modernisation and social change in a comparative context using case studies in

countries of Western Europe, Latin America, East and South-East Asia. The lectures will highlight a number of key issues, for example whether the processes of social change are universal or specific; the consequences of modernisation in and for the economy, politics, society, culture and ideology of non-Western societies; and whether the established Eurocentric analytical models are still useful in understanding the modern world. It will be emphasised that differing interpretations of modernisation flow from various relations of power which lead to a multiplicity of views on its meanings and significance.

976301

Contemporary South-East Asia

8cp; 2nd semester, 4hpw

This subject provides an introduction to the countries of Indonesia, Malaysia and Thailand. The themes of modernity and identity will be examined at a political-economic level and also at the individual level. Issues which will be explored include migration patterns in the context of regional interrelationships; increasing urbanisation; legacies of colonialism; the commodification of culture and the growing impact of tourism; new creative forms in the visual, literary and performing arts; the beliefs about and behaviour of women in the region; and ways in which religion and social practice intersect.

97731x

In-country Study 1: Indonesia

24cp; prerequisite: completion of 32 credit points in Language and Culture subjects as appropriate to the student's major

97833x

In-country Study 2: Malaysia

24cp; prerequisite: 97731x In-country Study 1: Indonesia

Information on In-country Study in South-East Asia

Content and assessment

Students spend two consecutive semesters studying language and culture at institutions in each of Indonesia and Malaysia through arrangements made by the Institute. The focus of study varies each semester depending on the student's level of language competence, individual student preferences and the availability of subjects at host institutions.

Students are assessed on each semester separately. In-country Study is assessed through assignments organised by the Institute for International Studies, which include project work set by the Institute in addition to formal curricular activities at the host in-country institution. These additional assignments relate to contemporary Indonesian and Malaysian society and can be geared to individual students' interests.

Locations

Malaysia

Penang

Penang was the first of the Straits Settlements: – areas in which the British set up their empire trading outposts in the 18th century. It is now a bustling economic and tourist centre with some of the largest semi-conductor factories in the world and a plethora of high-rise hotels along the northern beaches. The Universiti Sains Malaysia (USM), Penang was established as the second university in the country in 1969. It was first known as Universiti Pulau Pinang. In 1971, it took over the former military camp at Minden, a 239.4-hectare site which is about 10 kilometres south of the city of Georgetown. The student population has expanded rapidly and is now almost 19,000. Further expansion saw the setting up of two branch campuses at Kubang Kerian, Kelantan and Tronoh, Perak; the former houses the medical school and University Hospital while the latter houses the existing five engineering schools.

Indonesia

Yogyakarta

Yogyakarta is one of the art centres of Indonesia. It is rich with an array of architectural and cultural delights, from the performing arts to visual arts and intricate crafts. It also has a rich political and social history being the site of nationalist revolutionary activity during the mid-1940s and the centre of an active Sultanate. The region is given a distinguished place by the Indonesian government, being designated as *Daerah Istimewa* (special region). The Universitas Gadjah Mada (UGM), Yogyakarta dates back to 1946, when during the turmoil of independence wars, a private foundation was established in Yogyakarta by a group of Indonesian intellectuals and nationalists under the auspices of the Sultan of Yogyakarta. Now it is the biggest university in the country

with more than 37,000 students and over 2,000 faculty members.

Costs

The two semester of In-country Study are full-credit subjects at UTS for which HECS is payable. Students receiving Austudy in Australia are still eligible to receive it while they are engaged in a period of In-country Study in Malaysia and Indonesia. The costs of tuition in host institutions overseas and travel between Sydney and the designated host institutions are borne by UTS except in cases where a scholarship has been awarded to the student with provision for these costs. Under those circumstances, the funds that would otherwise have been allocated towards the student's tuition and travel will be redirected to support the In-country Study program in general. Students may expect that costs incurred in undertaking a period of In-country Study are no greater than the costs of living away from home in Sydney.

The information on the program of In-country Study in South-East Asia is correct at the time of going to press. However, the Institute for International Studies reserves the right to make alterations to the location and content of any program of In-country Study at any time.

SPAIN MAJOR

Outline

Spain is an increasingly important part of the European Union. With a rich and long history, its development has been both singular and part of the main trends of European evolution. Students in the Spain major have the opportunity to learn Spanish and Catalan (where possible), to learn about Spain and Europe, and to spend an academic year of study in one of Barcelona, Salamanca or Malaga universities. The UTS Language and Culture program accepts students with varying degrees of language ability ranging from complete beginners to native speakers.

Language and Culture

971501	Spanish Language and Culture 1	8cp
972501	Spanish Language and Culture 2	8cp
973501	Spanish Language and Culture 3	8cp
974501	Spanish Language and Culture 4	8cp

Contemporary Society

50140	Modernisation and Social Change	8cp
976401	Contemporary Europe	8cp

In-country Study

97745x	In-country Study 1: Spain	24cp
97845x	In-country Study 2: Spain	24cp

Subject descriptions**971501, 972501, 973501, 974501****Spanish Language and Culture**

This language program is designed for students who are either complete beginners or who first learnt Spanish at school in Australia. There are two points of entry: the first for complete beginners; the second for students who have successfully completed HSC, or its equivalent. Students take four units in the program, either units 1–4 (beginners) or 3–6 (post-HSC), determined by their point of entry.

Students with a language competence in Spanish that is higher than the program offered at UTS may be able to undertake further studies of Spanish at other universities in the Sydney area through arrangements made by the Institute.

The language program is organised to cover a broad range of situations relevant to daily interaction in Spanish. The focus is on the development of speaking, listening, reading and writing skills appropriate to the situations that students are likely to encounter. Vocabulary and grammar are learnt in each subject, during the In-country Study period, centred on written and audiovisual materials encompassing a range of themes and situations.

Upon successful completion of the program, students would be expected to be able to communicate about familiar things, events and opinions and to have developed skills and strategies for continuing their learning of the language in Spanish-speaking countries. Those students with prior learning of Spanish entering the program at higher level would be expected to be able to communicate comfortably on a wide range of themes with the ability to adjust their language according to social variables such as formality, age and status. Each subject will be covered in one semester (13 weeks). There are six hours of language classes per week.

Further descriptions of each subject can be found in the Language Studies section of this handbook.

50140**Modernisation and Social Change**

(Faculty of Humanities and Social Sciences)
8cp; 4hpw

The aim of this subject is to provide students with an understanding of the processes of modernisation and social change in a comparative context using case studies in countries of Western Europe, Latin America, East and South-East Asia. The lectures will highlight a number of key issues, for example whether the processes of social change are universal or specific; the consequences of modernisation in and for the economy, politics, society, culture and ideology of non-Western societies; and whether the established Eurocentric analytical models are still useful in understanding the modern world. It will be emphasised that differing interpretations of modernisation flow from various relations of power which lead to a multiplicity of views on its meanings and significance.

976401**Contemporary Europe**

8cp; 2nd semester; 4hpw

This unit is an introduction and an overview laying the groundwork for the study of contemporary Europe. It surveys present-day European Union institutions and sociopolitical developments and provides a comparative study of political and social developments in the countries of Western and Eastern Europe. It aims to provide students with an understanding of the historical background of the present-day Europe and enable them to identify major contemporary policy issues in this region of the world.

97745x**In-country Study 1: Spain**

24cp; prerequisite: completion of 32 credit points in Language and Culture subjects as appropriate to the student's major

97845x**In-country Study 2: Spain**

24cp; prerequisite: 97745x In-country Study 1: Spain

Information on In-country Study in Spain

Content and assessment

Students spend up to two consecutive semesters studying language and culture at one of the Autonomous University of Barcelona (UAB), the University of Salamanca or the University of Malaga, through arrangements made by the Institute. Where possible, the study of language and culture is geared more to the professional training of the students. Students are assessed each semester separately and assessment is based on the subjects undertaken at the host institutions, as well as project and essay work administered by the Institute for International Studies.

Locations

Barcelona

The capital of Catalunya is at the heart of one of Europe's major regions of economic growth. Barcelona has long been a centre for artistic and architectural developments that have defined those fields during the 20th century. Students who select Barcelona for their period of In-country Study will spend up to two consecutive semesters studying language and culture at the Autonomous University of Barcelona (UAB) through arrangements made by the Institute. In the first semester, they will further their Spanish language and culture studies and attend classes alongside local students undertaking one subject on the contemporary society of Spain. During the second semester, students will continue their Spanish language and culture studies at a reduced load and attend regular classes at the UAB in two subjects selected from a list of options on contemporary Catalan and Spanish history, culture, economics, politics and society and Catalan language.

Salamanca

Salamanca is a town situated two hours' drive from Madrid. Its historic town centre has some of the finest examples of Spanish renaissance and baroque styles including the University of Salamanca itself. One of the most important parts of the town's daily life are the activities surrounding this university.

UTS students at the University of Salamanca will undertake further studies of Spanish language and culture depending on their individual level of language proficiency, as well as two subjects from the regular curriculum of the university.

Malaga

Malaga is a coastal town, part of the Costa del Sol, with all the attractions of the Andalusian culture and landscape. It is one-and-a-half hours' drive south from Granada.

UTS students at the University of Malaga will undertake three subjects from the regular curriculum of the university each semester and will be tutored in Spanish language.

Costs

The two semesters of In-country Study are full-credit subjects at UTS for which HECS is payable. Students receiving Austudy in Australia are still eligible to receive it while they are engaged in a period of In-country Study in Spain. The costs of tuition in host institutions overseas and travel between Sydney and the designated host institutions are borne by UTS except in cases where a scholarship has been awarded to the student with provision for these costs. Under those circumstances, the funds that would have otherwise been allocated towards the student's tuition and travel will be redirected to support the In-country Study program in general. Students may expect that no greater costs will be incurred through undertaking a period of In-country Study in Spain than are involved in living away from home in Sydney.

The following information on programs of In-country Study in Spain is correct at the time of going to press. However, the Institute for International Studies reserves the right to make alterations to the location and content of any program of In-country Study at any time.

TAIWAN MAJOR

Outline

Taiwan has become an integral part of East Asia and a major force in the Asia-Pacific region. The economic integration of Taiwan, Hong Kong and the southern provinces of China has, since the late 1980s, made this part of East Asia one of the fastest-growing areas in the world. Taiwan has, in its own right, achieved dramatic sustained economic growth through the 1970s, 1980s and 1990s. By the end of the century, it is likely to have an economy equal to that of Australia.

Understanding Taiwan and its development is important not only for those interested in Chinese studies or international relations,

but also for any graduates whose work and careers are likely to take them to Taiwan or bring them into contact with Taiwan-based or Taiwan-related concerns. Taiwan has been one of Australia's major trading partners for almost a decade and there are also considerable two-way flows of investment.

The Taiwan major at UTS is the only such course of study in Australia. Students in the Taiwan major study the Chinese language and culture; learn about the history, politics, economics and society of contemporary Taiwan and South China; and travel to Taiwan to study for one academic year at an institution of higher education. There are also opportunities for students to study classical Chinese.

Language and Culture

971111	Chinese Language and Culture 1	8cp
972111	Chinese Language and Culture 2	8cp
973111	Chinese Language and Culture 3	8cp
974111	Chinese Language and Culture 4	8cp

Contemporary Society

50140	Modernisation and Social Change	8cp
976101	Chinese East Asia	8cp

In-country Study

97713x	In-country Study 1: Taiwan	24cp
97813x	In-country Study 2: Taiwan	24cp

Subject descriptions

971111, 972111, 973111, 974111

Chinese Language and Culture

This program is open to students who are either complete beginners, who first learnt Chinese at secondary school level in Australia or who already have a working knowledge of Chinese characters and communicative competence in a Chinese language other than Modern Standard Chinese. There are three points of entry into this program: Chinese 1 for complete beginners, Chinese 3 for students who have successfully completed HSC 2/3-unit Chinese and Chinese 7 for students who have a working knowledge of Chinese characters as well as communicative competence in a Chinese language other than Modern Standard Chinese. Students take four consecutive units in the program, usually either units 1–4, 3–6 or 7–10, determined by their point of entry. Other programs may be negotiated according to the student's level of proficiency.

The Chinese language program is designed to provide students with the communicative skills necessary to undertake In-country study in China. A communicative approach is adopted for classroom instruction and students are expected to participate fully in class activities in the process of acquiring practical language skills. The teaching incorporates an introduction to Chinese culture and helps students to appreciate the wider cultural ramifications of Chinese in various contexts. The program will lay a solid foundation for further cultural studies in Chinese.

In exceptional circumstances, students with advanced skills in Chinese will be excluded from the Chinese Language and Culture program and will be required to substitute other appropriate subjects from the List of Approved Substitute Subjects. These subjects may be other subjects on offer in the International Studies program, including those relating to the study of Contemporary Society or those focusing on another Language and Culture. For details of substitute subjects, see the List of Approved Substitute Subjects. Students interested in studying classical Chinese or Chinese at a level not currently offered at UTS should inquire at the Institute about the possibility of undertaking Chinese subjects offered at other institutions. Students will need to obtain the approval of the Board of Studies of the Institute before they can vary any of their subjects of study in the International Studies program.

Further descriptions of each subject can be found in the Language Studies section of this handbook.

50140

Modernisation and Social Change

(Faculty of Humanities and Social Sciences)

8cp; 4hpw

The aim of this subject is to provide students with an understanding of the processes of modernisation and social change in a comparative context using case studies in countries of Western Europe, Latin America, East and South-East Asia. The lectures will highlight a number of key issues, for example whether the processes of social change are universal or specific; the consequences of modernisation in and for the economy, politics, society, culture and ideology of non-Western societies; and whether the established Eurocentric analytical models are still useful

in understanding the modern world. It will be emphasised that differing interpretations of modernisation flow from various relations of power which lead to a multiplicity of views on its meanings and significance.

976101

Chinese East Asia

8cp; 2nd semester, 4hpw

South China – Hong Kong, Taiwan and the Southern Chinese provinces of Fujian and Guangdong – is a region of global importance. It is a dynamo of economic growth for the East Asia region that has grown out of the economic integration of Hong Kong, Taiwan and South China, and is now expanding to include East China. Yet its constituent parts have developed separately in different and often inimical political systems. As a result of all of these factors, South China is likely to be of increasing importance strategically and politically, as well as economically. This subject examines the development of Hong Kong, Taiwan and South China and their interaction. It is an introductory subject that requires no prior knowledge of the region or of any Chinese language.

97713x

In-country Study 1: Taiwan

24cp; prerequisite: completion of 32 credit points in Language and Culture subjects as appropriate to the student's major

97813x

In-country Study 2: Taiwan

24cp; prerequisite: 97713x In-country Study 1: Taiwan

Information on In-country Study in Taiwan

Content and assessment

Students spend two consecutive semesters studying language and culture at the National Chengchi University through arrangements made by the Institute. In the first semester the focus is on the study of language and culture. In the second semester, where possible, the study of language and culture is geared more to the professional training of the students. Students are assessed on each semester separately and assessment is based on the subjects undertaken at the host institutions, as well as project and essay work administered by the Institute for International Studies.

Location

Taipei

Taipei, situated on the northern tip of Taiwan Island, is the capital of the Republic of China on Taiwan. It rests in a basin surrounded by mountains and crisscrossed by rivers. Taipei is truly a city of many faces, where traditional Chinese lifestyles and culture coexist with modern buildings and bustling business. The climate of Taipei is not much different from that of Sydney, though it is a bit colder during the winter. National Chengchi University, located in the South-Eastern suburbs of Taipei, is one of the leading universities in Taiwan. It is at the foot of Mt Chihnan, which provides a tranquil environment for studying.

Costs

The two semesters of In-country Study are full-credit subjects at UTS for which HECS is payable. Students receiving Austudy in Australia are still eligible to receive it while they are engaged in a period of In-country Study in Taiwan. The costs of tuition in host institutions overseas and travel between Sydney and the designated host institutions are borne by UTS except in cases where a scholarship has been awarded to the student with provision for these costs. Under those circumstances, the funds that would have otherwise been allocated towards the student's tuition and travel will be redirected to support the In-country Study program in general. Students may expect that no greater costs will be incurred through undertaking a period of In-country Study in Taiwan than are involved in living away from home in Sydney.

The information on the program of In-country Study in Taiwan is correct at the time of going to press. However, the Institute for International Studies reserves the right to make alterations to the location and content of any program of In-country Study at any time.

THAILAND MAJOR

Outline

Thailand is both an economic powerhouse and a fascinating political enigma of mainland South-East Asia. With a population of some 60 million people, it has not only experienced economic growth during the last three decades, but has a long, uninterrupted history of political continuity. Unlike most of South-East Asia, it has not experienced a colonial era and retains a traditional monarchy. Thailand is a devoutly Buddhist society, but is also affected by Islamic and Sinitic influences.

Language and Culture

971320 Thai 1	8cp
972320 Thai 2	8cp
973320 Thai 3	8cp
974320 Thai 4	8cp

Contemporary Society

50140 Modernisation and Social Change	8cp
976301 Contemporary South-East Asia	8cp

In-country Study

977322 In-country Study 1: Thailand	24cp
978322 In-country Study 2: Thailand	24cp

Subject descriptions

971320, 972320, 973320, 974320

Thai

A Thai language program is made available to UTS students through the Languages Consortium established by universities in the Sydney metropolitan area. The Thai language program is taught by staff at the University of Sydney. The program is geared to the needs of complete beginners, although students with some previous knowledge of Thai may also be accommodated.

50140

Modernisation and Social Change

(Faculty of Humanities and Social Sciences)
8cp; 4hpw

The aim of this subject is to provide students with an understanding of the processes of modernisation and social change in a comparative context using case studies in countries of Western Europe, Latin America, East and South-East Asia. The lectures will highlight a number of key issues, for example whether the processes of social change are

universal or specific; the consequences of modernisation in and for the economy, politics, society, culture and ideology of non-Western societies; and whether the established Eurocentric analytical models are still useful in understanding the modern world. It will be emphasised that differing interpretations of modernisation flow from various relations of power which lead to a multiplicity of views on its meanings and significance.

976301

Contemporary South-East Asia

8cp; 2nd semester, 4hpw

This subject provides an introduction to the countries of Indonesia, Malaysia and Thailand. The themes of modernity and identity will be examined at a political-economic level and also at the individual level. Issues which will be explored include migration patterns in the context of regional interrelationships; increasing urbanisation; legacies of colonialism; the commodification of culture and the growing impact of tourism; new creative forms in the visual, literary and performing arts; the beliefs about and behaviour of women in the region; and ways in which religion and social practice intersect.

977322

In-country Study 1: Thailand

24cp; prerequisite: completion of 32 credit points in Language and Culture subjects as appropriate to the student's major

978322

In-country Study 2: Thailand

24cp; prerequisite: 977322 In-country Study 1: Thailand

Information on In-country Study in Thailand

Content and assessment

Students spend two consecutive semesters studying language and culture at Khon Kaen University through arrangements made by the Institute. In the first semester the focus is on the study of language and culture. In the first semester students will undertake an intensive Thai language program. In the second semester, the students will continue their language studies and attend specific courses relating to Thai Society. Students are assessed on each semester separately

and assessment is based on the subjects undertaken at the host institutions, as well as project and essay work administered by the Institute for International Studies.

Costs

The two semesters of In-country Study are full-credit subjects at UTS for which HECS is payable. Students receiving Austudy in Australia are still eligible to receive it while they are engaged in a period of In-country Study in Thailand. The costs of tuition in host institutions overseas and travel between Sydney and the designated host institutions are borne by UTS except in cases where a scholarship has been awarded to the student with provision for these costs. Under those circumstances, the funds that would have otherwise been allocated towards the student's tuition and travel will be redirected to support the In-country Study program in general. Students may expect that no greater costs will be incurred through undertaking a period of In-country Study in Thailand than are involved in living away from home in Sydney.

The information on the program of In-country Study in Thailand is correct at the time of going to press. However, the Institute for International Studies reserves the right to make alterations to the location and content of any program of In-country Study at any time.

UKRAINE MAJOR

Outline

Settled since ancient times, Ukraine has a long tradition of cultural identity and statehood. Ukraine means borderland, and like many borderlands, its fate has been to be a battleground and coveted prize for a number of surrounding empires. Economic reforms in Ukraine are slow, although some foreign investment has occurred in recent years. Ukraine has the agricultural potential to achieve prosperity and landmark legislation has been introduced to encourage this. The Ukraine major is restricted to students who have a sound working knowledge of the Ukrainian language. Students in the Ukrainian major study Ukrainian language and culture; learn about the history, politics, economics and society of contemporary Ukraine; and travel to Ukraine to study for one academic year at an institution of higher education.

Language and Culture

971774	Ukrainian 1	8cp
972774	Ukrainian 2	8cp
973774	Ukrainian 3	8cp
974774	Ukrainian 4	8cp

Contemporary Society

50140	Modernisation and Social Change	8cp
976401	Contemporary Europe	8cp

In-country Study

977770	In-country Study 1: Ukraine	24cp
978770	In-country Study 2: Ukraine	24cp

Subject descriptions

971774, 972774, 973774, 974774

Ukrainian

Ukrainian is offered to UTS students through an arrangement with Macquarie University. To enter the program students in the International Studies program must have a sound knowledge of Ukrainian. Students are placed in classes appropriate to their level of competence. The Ukrainian language program allows students to improve their reading, writing and oral skills with particular emphasis being placed in the study of grammar and syntax.

50140

Modernisation and Social Change

(Faculty of Humanities and Social Sciences)
8cp; 4hpw

The aim of this subject is to provide students with an understanding of the processes of modernisation and social change in a comparative context using case studies in countries of Western Europe, Latin America, East and South-East Asia. The lectures will highlight a number of key issues, for example whether the processes of social change are universal or specific; the consequences of modernisation in and for the economy, politics, society, culture and ideology of non-Western societies; and whether the established Eurocentric analytical models are still useful in understanding the modern world. It will be emphasised that differing interpretations of modernisation flow from various relations of power which lead to a multiplicity of views on its meanings and significance.

976401**Contemporary Europe***8cp; 2nd semester, 5hpw*

This unit is an introduction which lays the groundwork for the study of contemporary Europe. It surveys present-day European Union institutions and sociopolitical developments and provides a comparative study of political and social developments in the countries of Western and Eastern Europe. It aims to provide students with an understanding of the historical background of the present-day Europe and enable them to identify major contemporary policy issues in this region of the world.

977770**In-country Study 1: Ukraine**

24cp; prerequisite: completion of 32 credit points in Language and Culture subjects as appropriate to the student's major

978770**In-country Study 2: Ukraine**

24cp; prerequisite: 977770 In-country Study 1: Ukraine

Information on In-country Study in Ukraine**Content and assessment**

Students spend two semesters studying at an institution of higher education in Ukraine, through arrangements made by the Institute. The program of study focuses on the history, culture and society of Ukraine. Subjects to be incorporated into the program of study are negotiated in consultation with the Institute for International Studies Coordinator and the Coordinator at the Ukrainian institution. Students are assessed on each semester separately and assessment is based on the subjects undertaken at the host institutions, as well as project and essay work administered by the Institute for International Studies.

Costs

The two semesters of In-country Study are full-credit subjects at UTS for which HECS is payable. Students receiving Austudy in Australia are still eligible to receive it while they are engaged in a period of In-country Study in Ukraine. The costs of tuition in host institutions overseas and travel between Sydney and the designated host institutions are borne by UTS except in cases where a scholarship has been awarded to the student with provision for these costs. Under those circumstances, the funds that would have otherwise been allocated towards the student's tuition and travel will be redirected to support the In-country Study program in general. Students may expect that no greater costs will be incurred through undertaking a period of In-country Study in Ukraine than are involved in living away from home in Sydney.

SPECIAL ARRANGEMENTS

Under certain circumstances, some students may need to vary the subjects of study prescribed by their major in the International Studies program.

Foreseeable reasons for such variation are:

- the level of language proficiency does not permit further study at UTS;
- there are individual and particular difficulties in undertaking a period of In-country Study.

In these and other exceptional circumstances, special arrangements can be made to cater for individual needs.

Under such circumstances, students are required to study one or more subjects from the list of approved substitutes to the equivalent value in credit points.

For any amendment so the course of study prescribed in the International Studies program, students need approval from the Board of Studies of the Institute for International Studies.

LIST OF APPROVED SUBSTITUTE SUBJECTS

Language and Culture subjects: Cantonese, Chinese, Croatian, French, German, Greek, Indonesian, Italian, Japanese, Malaysian, Polish, Russian, Slovenian, Spanish, Thai and Ukrainian.

- Asian and Pacific Politics
- Chinese East Asia
- Colonialism and Post-Colonialism
- Comparative Religions
- Contemporary China
- Contemporary Cultures 1
- Contemporary Cultures 2
- Contemporary Europe
- Contemporary Japan
- Contemporary Latin America
- Contemporary South-East Asia
- Gender, Culture and Power
- International Legal Studies
- International Politics
- Colonialism and Modernity
- Power and Change in Australia
- Power, Race and Ethnicity

All subjects in International Studies, except In-country Studies, have a value of eight credit points and are taught over one semester.

For further details, refer to the Language Studies section of this handbook.

52300

Asian and Pacific Politics

(Faculty of Humanities and Social Sciences)
8cp; 3hpw

This subject focuses on the history and current situation of societies and states in South-East Asia and the Pacific, with reference to Australian foreign policy and aid policies in the region. The Pacific rim has been the site of dynamic development in the late 20th century, while the Pacific region is variously described as an American lake, a nuclear dumping ground, an area of vital strategic significance to the superpowers and a tourist haven. This subject analyses social, political and economic trends in the area.

976101**Chinese East Asia***8cp; 2nd semester, 4hpw*

South China Hong Kong, Taiwan and the Southern Chinese provinces of Fujian and Guangdong – is a region of global importance. It is a dynamo of economic growth for the East Asia region that has grown out of the economic integration of Hong Kong, Taiwan and South China, and which is now expanding to include East China. Yet its constituent parts have developed separately in different and often inimical political systems. As a result of all of these factors, South China is likely to be of increasing importance strategically and politically, as well as economically. This subject examines the development of Hong Kong, Taiwan and South China and their interaction. It is an introductory subject that requires no prior knowledge of the region or of any Chinese language.

52321**Colonialism and Post-Colonialism***(Faculty of Humanities and Social Sciences)**8cp; 3hpw*

In this subject, students will inquire into the processes of colonialism by examining both the colonised and the coloniser, and by considering the elements of race, ethnicity and gender. Students will be asked to consider the meaning of and potential for 'post-colonial' history. The subject will raise these issues by exploring the interaction of colonising and colonised societies. The countries studied will usually be England, India and Australia although, depending on teaching staff interests, other countries may be studied. These interacting societies will be examined over a coinciding period, such as the 1850s, when colonial power relations were dominant but were also contested by both the colonised peoples and by groups within the coloniser societies. Alternatively, the understanding and representation of issues such as violence, resistance, development or 'the nation' will be compared in each set of societies. Particular attention will be paid to the recent writings of analysts from previously colonised societies, who are attempting to define and review 'post-colonial' history. Students will be required to conduct research on primary documents (in English) and write a comparative analysis of the period.

52302**Comparative Religions***(Faculty of Humanities and Social Sciences)**8cp; 3hpw*

This subject will cover some of the following topics: comparative religion and social structure, religious symbolism, magical belief and practices, religious philosophy, knowledge and transcendental thought. The content of the course will vary from year to year.

976111**Contemporary China***8cp; 2nd semester, 4hpw*

This subject examines the contours and dynamics of social, political and economic change in the People's Republic of China since the death of Mao Zedong and the start of the reform era. A central theme is the emerging relationship between state and society in a state socialist system in the process of change and reform. It is an introductory subject that requires no prior knowledge of the People's Republic of China or of any Chinese language.

50228**Contemporary Cultures I***(Faculty of Humanities and Social Sciences)**8cp*

This subject will investigate forms of culture as they appear in the late 20th century Australia. Employing a Cultural Studies approach, it aims to provide methods for analysing complex cultural phenomena in a media-saturated environment. The cultural complexity studied emerges through Aboriginal, Islander, European and other traditions and their hybrid forms. Theories associated with the textual manifestations of these traditions are presented, including modes of signification and representation, cultural and social differences, canons and their contestations and generic and multi-generic forms. Media and multimedia are studied as written, visual and aural products which have specific institutional bases (e.g. Hollywood) for their production and particular audiences for their consumption.

50229**Contemporary Cultures 2***(Faculty of Humanities and Social Sciences)**8cp*

This subject will introduce students to the main concepts and methods of the field of Cultural Studies. The subject will present critical readings in the broad field of Cultural Studies in the first half of the semester before proceeding in the second half to a specific case study, for example, the city, performing popular culture, bodies and sexualities, or critiques of anthropology.

976401**Contemporary Europe***8cp; 2nd semester, 5hpw*

This unit is an introduction and an overview laying the groundwork for the study of contemporary Europe. It surveys present-day European Union institutions and sociopolitical developments and provides a comparative study of political and social developments in the countries of Western and Eastern Europe. It aims to provide students with an understanding of the historical background of the present-day Europe and enable them to identify major contemporary policy issues in this region of the world.

976211**Contemporary Japan***8cp; 2nd semester, 4hpw*

This subject provides an introduction to the dynamics of political, social and economic systems in Modern Japan. Central themes are the causes and consequences of social change and continuity in the context of Japan's emergence as an economic superpower. In the process, it offers a general introduction to Japan's culture. This subject requires no prior knowledge of Japan or of Japanese.

976501**Contemporary Latin America***8cp; 2nd semester, 4hpw*

Latin America has been a crucible for social, political and economic change in the 19th and 20th centuries. Intense struggles for nationhood, democracy, economic modernisation, and secularisation, have all resonated in the countries of Latin America. During the middle of the 20th century Latin America's primary concerns were focused

on national self-determination, inward industrialisation, and populist authoritarian efforts to legitimise elite rule. In the late 20th century the emphasis has shifted towards economic growth, internationalisation, and pressures to improve the capacity and accountability of governments. The unit aims to provide students with the historical background, cultural awareness and analytic skills to interpret everyday social, political and economic reality during their period of In-country study. The subject requires no prior knowledge of Latin America or of Spanish.

976301**Contemporary South-East Asia***8cp; 2nd semester, 4hpw*

This subject provides an introduction to the countries of Indonesia, Malaysia and Thailand. The themes of modernity and identity will be examined at a political-economic level and also at the individual level. Issues which will be explored include migration patterns in the context of regional interrelationships; increasing urbanisation; legacies of colonialism; the commodification of culture and the growing impact of tourism; new creative forms in the visual, literary and performing arts; the beliefs about and behaviour of women in the region; and ways in which religion and social practice intersect.

52306**Gender, Culture and Power***(Faculty of Humanities and Social Sciences)**8cp; 3hpw*

This subject focuses on the social and historical construction of gender and sexuality, and on the institutional, representational and discursive practices which reproduce and alter gender power relations. It examines various feminist perspectives developed to analyse and confront the dynamics of sexual and gender oppression.

77600**International Legal Studies**

(Faculty of Law)
8cp; 4hpw

This subject deals with the comparative methods of legal research, and examines the growing 'interdependence' and similarity of the civil law and common law systems.

The subject consists of two sections.

The first section consists of an overview of the major legal systems in the world. These legal systems will be compared with the common law system. Among the topics covered will be an examination of the meaning, sources and structure of law in the legal systems under consideration.

The second section allows students to look at the reception of legal systems in the countries of their International Studies majors. This may be illustrated with the example of the reception of English law and Islamic law in the countries of South and South-East Asia.

52222**International Politics**

(Faculty of Humanities and Social Sciences)
8cp; 3hpw

This subject focuses on the global political and economic structure and its inherent problems. It examines the role of the IMF, World Bank, United Nations and GATT, and assesses attempts to erect a post-Cold War new world order based on global capitalism, human rights and democracy. Problems discussed will include environmental degradation, Third World debt, the feminisation of poverty, and the growing gap between rich and poor.

50231**Colonialism and Modernity**

(Faculty of Humanities and Social Sciences)
8cp

This subject will allow students to analyse Australia's situation in relation to the world and our region by investigating the history of colonialism, including its engagement with modernity and the history of anti-colonial movements. Students will deepen their knowledge of the political, economic, social and cultural processes of colonial expansion and imperialism as they affected the colonised peoples, the colonising settlers and the metropolitan powers. The subject will investigate the development of 'modernity' in

Europe and its colonies. The subject will explore the roots of many present-day intellectual disciplines and tools, investigating, for example, the relationship between anthropology and colonialism, as well as the role of new technologies such as photography in colonial processes. Using international and Australian comparisons, the subject will introduce students to many perspectives: those of colonised indigenous peoples; those of members of diasporas (the populations which were dispersed by invasion, slavery and indentured labour schemes); those of the invading 'settlers' who established the colonies and those of people remaining in or migrating into the colonisers' home country.

50230**Power and Change in Australia**

(Faculty of Humanities and Social Sciences)
8cp

This subject is focused on the question of how decisions are made in Australia. Students will investigate three case studies where decisions were taken after periods of intense conflict and debate. These case studies will introduce students to the varying but complementary approaches of historians, political scientists, anthropologists and sociologists in their analyses of the ways power is exercised, of the importance of collective beliefs and values and of the many formal and informal processes by which Australians generate and experience change. Students will be asked to investigate critically the relationships between the different arenas of decision making: from the floor of Parliament, to the negotiating tables 'behind the scenes', from the public drama of street demonstrations, to the 'private' sites of kitchen, bedroom and everyday life.

52316**Power, Race and Ethnicity**

(Faculty of Humanities and Social Sciences)
8cp; 3hpw

This subject looks at theories of colonialism and post-colonialism in relation to orientalism, racism and ethnicity. The focus of the subject will vary from year to year depending on the theme chosen. Examples may be orientalist theory and popular culture; social and historical theories of race and ethnicity; and migration (national and global), cultural pluralism and diaspora communities.

Undergraduate courses

LIST OF COURSES

The Institute for International Studies offers the degree of Bachelor of Arts in International Studies through combined degree programs only. Twenty-six combined degrees have been established between the Institute for International Studies and the Faculties of Business; Design, Architecture and Building; Education; Engineering; Humanities and Social Sciences; Law; Mathematical and Computing Sciences; Nursing; and Science. These are:

Course name	Code
Bachelor of Business/Bachelor of Arts in International Studies	B006
Bachelor of Arts in Human Movement Studies and in International Studies	BL15
Bachelor of Arts in Leisure Management and in International Studies	BL17
Bachelor of Arts in Tourism Management and in International Studies	BL16
Bachelor of Building in Construction Economics/Bachelor of Arts in International Studies	AB08
Bachelor of Building in Construction Management/Bachelor of Arts in International Studies	AB09
Bachelor of Design in Fashion and Textile Design/Bachelor of Arts in International Studies	DF03
Bachelor of Design in Interior Design/Bachelor of Arts in International Studies	DT02
Bachelor of Design in Industrial Design/Bachelor of Arts in International Studies	DD02
Bachelor of Design in Visual Communication/Bachelor of Arts in International Studies	DV02
Bachelor of Land Economics/Bachelor of Arts in International Studies	AB10
Bachelor of Education/Bachelor of Arts in International Studies	TE21
Bachelor of Engineering, Diploma in Engineering Practice/Bachelor of Arts in International Studies	xxxx
Bachelor of Applied Science in Information Studies/Bachelor of Arts in International Studies	HL12
Bachelor of Arts in Social Science and in International Studies	HH06
Bachelor of Arts in Communication (Journalism) and in International Studies	H026
Bachelor of Arts in Communication (Media Arts and Production) and in International Studies	H027
Bachelor of Arts in Communication (Public Communication) and in International Studies	H028
Bachelor of Arts in Communication (Writing and Contemporary Cultures) and in International Studies	H029
Bachelor of Laws/Bachelor of Arts in International Studies	LL07
Bachelor of Science in Computing Science/Bachelor of Arts in International Studies	MC05
Bachelor of Science in Mathematics/Bachelor of Arts in International Studies	MM05
Bachelor of Mathematics and Finance/Bachelor of Arts in International Studies	MM06
Bachelor of Nursing/Bachelor of Arts in International Studies	KN10
Bachelor of Health Science in Acupuncture/Bachelor of Arts in International Studies	NH01
Bachelor of Science/Bachelor of Arts in International Studies	N004

Bachelor of Business/ Bachelor of Arts in International Studies

Course code: B006

The Bachelor of Business/Bachelor of Arts in International Studies is offered jointly by the Faculty of Business and the Institute for International Studies, UTS. The five-year full-time degree integrates the study of Business with a major in the language and culture of another country. Students spend the fourth year of study at a university overseas.

Admission requirements

Admission to the combined degree will be on merit according to the admissions policy for the Bachelor of Business. There are no prior language requirements for the International Studies component of this combined degree, however, some majors within the International Studies program do have specific admission requirements. Entry to the Greece, Poland, Slovenia and Ukraine majors is restricted to students who have a sound working knowledge of the language of their selected specialisation. Students are admitted to the International Studies program with no guarantee of entry to a specific major, although every effort is made to meet their preferences.

Arrangements for In-country Study

All students are required to complete four consecutive semesters of study of language and culture before proceeding to In-country Study. The costs of tuition in host institutions overseas and travel between Sydney and the designated host institutions are borne by UTS except in cases where a scholarship has been awarded to the student with provision for these costs. Under those circumstances, the funds that would have otherwise been allocated towards the student's tuition and travel will be redirected to support the In-country Study program in general. In most cases the cost of living for the period of In-country Study will not exceed the cost of living away from home in Sydney. However, students should be aware that the cost of living in some countries – notably Argentina, France, Germany, Hong Kong, Japan and Taiwan – may be higher than in Sydney.

Course structure

All students must complete 240 credit points of study comprising 144 credit points relating to the Bachelor of Business and 96 credit points relating to the Bachelor of Arts in International Studies. For full details of the Bachelor of Business component of the combined degree, please refer to the Bachelor of Business program in the *Faculty of Business Handbook*.

In the International Studies component, students choose one of the following majors – Argentina, Chile, China, Croatia, France, Germany, Greece, Indonesia, Italy, Japan, Latin America, Malaysia, Mexico, Poland, Russia, Slovenia, South China, South-East Asia, Spain, Taiwan, Thailand and Ukraine. Australia and the Asia-Pacific Region is available as a major for international students.

Each major includes 32 credit points (four x 8cp subjects) of instruction in Language and Culture; 8 credit points of study of Modernisation and Social Change; 8 credit points of study of Contemporary Society; and 48 credit points (two semesters) of study at an institution of higher education in a country of the major.

Course program

Semester 1

22105	Accounting A
21125	International Business Environment
25110	Microeconomics
26122	Quantitative Methods for Business
25308	Financial Markets

Semester 2

22205	Accounting B
21130	Management and Organisations
25209	Macroeconomics
25314	Business Finance
24105	Marketing Principles
79202	Business Law

Semester 3

2xxxx	Bachelor of Business first major
2xxxx	Bachelor of Business first major
971xxx	Language and Culture 1
50140	Modernisation and Social Change

Semester 4

2xxxx	Bachelor of Business first major
2xxxx	Bachelor of Business second major, sub-major or elective
972xxx	Language and Culture 2

Semester 5

2xxxx	Bachelor of Business first major
2xxxx	Bachelor of Business second major, sub-major or elective
973xxx	Language and Culture 3

Semester 6

2xxxx	Bachelor of Business first major
2xxxx	Bachelor of Business second major, sub-major or elective
974xxx	Language and Culture 4
976xxx	Contemporary Society

Semester 7

977xxx	In-country Study 1
--------	--------------------

Semester 8

978xxx	In-country Study 2
--------	--------------------

Semester 9

2xxxx	Bachelor of Business first major
2xxxx	Bachelor of Business first major
2xxxx	Bachelor of Business second major, sub-major or elective
2xxxx	Bachelor of Business second major, sub-major or elective

Semester 10

2xxxx	Bachelor of Business first major
2xxxx	Bachelor of Business second major, sub-major or elective
2xxxx	Bachelor of Business second major, sub-major or elective
2xxxx	Bachelor of Business second major, sub-major or elective
21609	Business Strategy

Further details of Business subjects may be found in the *Faculty of Business Handbook*. Alternatively, queries may be addressed to the Faculty of Business on 9514 3500 or 9514 5355. Queries regarding the International Studies component of the course should be addressed to the Institute itself on 9514 1574.

Combined degree students are required to confirm, during the University enrolment period, the subjects they intend to take for the year with the Institute at 9-11 Broadway (next door to the Co-op Bookshop).

Bachelor of Arts in Human Movement Studies and in International Studies

Course code: BL15

The Bachelor of Arts in Human Movement Studies and in International Studies is offered jointly by the Faculty of Business and the Institute for International Studies, UTS. The five-year full-time degree integrates Human Movement Studies with a major in the language and culture of another country. Students spend the fourth year of study at a university overseas.

Admission requirements

Admission to the combined degree will be on merit according to the admissions policy for the Bachelor of Arts in Human Movement Studies. There are no prior language requirements for the International Studies component of this combined degree, however, some majors within the International Studies program do have specific admission requirements. Entry to the Greece, Poland, Slovenia and Ukraine majors is restricted to students who have a sound working knowledge of the language of their selected specialisation. Study of Language and Culture depends on the individual student's level of language proficiency before entry to the program. There is a range of entry levels to the various Language and Culture programs. Students are admitted to the International Studies program with no guarantee of entry to a specific major, although every effort is made in trying to meet students' preferences.

Arrangements for In-country Study

All students are required to complete four consecutive semesters of study of language and culture before proceeding to In-country Study.

The costs of tuition in host institutions overseas and travel between Sydney and the designated host institutions are borne by UTS except in cases where a scholarship has been awarded to the student with provision for these costs. Under those circumstances, the funds that would have otherwise been allocated towards the student's tuition and travel will be redirected to support the In-country Study

program in general. In most cases the cost of living for the period of In-country Study will not exceed the cost of living away from home in Sydney. However, students should be aware that the cost of living in some countries – notably Argentina, France, Germany, Hong Kong, Japan and Taiwan – may be higher than in Sydney.

Course structure

All students must complete 240 credit points of study comprising 144 credit points relating to the Bachelor of Arts in Human Movement Studies and 96 credit points relating to the Bachelor of Arts in International Studies.

In the International Studies component, students choose one of the following majors – Argentina, Chile, China, Croatia, France, Germany, Greece, Indonesia, Italy, Japan, Latin America, Malaysia, Mexico, Poland, Russia, Slovenia, South China, South-East Asia, Spain, Taiwan, Thailand and Ukraine. Australia and the Asia-Pacific Region is available as a major for international students.

Each major includes 32 credit points (four x 8cp subjects) of instruction in Language and Culture; 8 credit points of study of Modernisation and Social Change; 8 credit points of study of Contemporary Society; and 48 credit points (two semesters) of study at an institution of higher education in a country of the major.

Course program

Semester 1

- 27183 Introduction to Human Movement Studies
- 65014 Chemistry (Human Movement)
- 27149 Performance Studies 1
- 27180 Functional Kinesiology
- 27189 Professional Practice 1

Semester 2

- 91429 Physiological Bases of Human Movement
- 27223 Mechanics of Human Motion
- 27106 Social Psychology of Leisure
- 27249 Performance Studies 2
- 27181 Human Motor Development
- 27189 Professional Practice 1 (cont.)

Semester 3

- 27152 Measurement and Development of Physical Capacity
- 971xxx Language and Culture 1
- 50140 Modernisation and Social Change
- 27155 Research Design and Statistics for Human Movement

Semester 4

- 27307 Administration of Australian Sport
- 27249 Performance Studies 2 (cont.)
- 27349 Performance Studies 3
- 27160 Sport and Exercise Behaviour
- 972xxx Language and Culture 2

Semester 5

- 27171 Applied Kinesiology
- 27175 Energetics of Human Movement
- 27186 Leisure and Human Movement in Social Context
- 27349 Performance Studies 3 (cont.)
- 973xxx Language and Culture 3

Semester 6

- 27173 Efficiency of Human Movement 1
- 27159 Social Issues in Sport and Exercise
- 974xxx Language and Culture 4
- 976xxx Contemporary Society

Semester 7

- 977xxx In-country Study 1

Semester 8

- 978xxx In-country Study 2

Semester 9

Kinesiology major

- 27449 Performance Studies 4
- 27331 Motor Learning and Control
- 27190 Professional Practice 2 – Project
- 2xxxx Bachelor of Arts in Human Movement Studies elective
- 2xxxx Bachelor of Arts in Human Movement Studies elective

Sports Management major

- 21130 Management and Organisations
- 22028 Accounting for Managers
- 27190 Professional Practice 2 – Project
- 2xxxx Bachelor of Arts in Human Movement Studies elective
- 2xxxx Bachelor of Arts in Human Movement Studies elective

Semester 10

Kinesiology major

- 27174 Efficiency of Human Movement 2
- 27222 Exercise Prescription
- 27190 Professional Practice 2 – Project (cont.)
- 27449 Performance Studies 4 (cont.)
- 2xxxx Bachelor of Arts in Human Movement Studies elective
- 2xxxx Bachelor of Arts in Human Movement Studies elective

Sports Management major

24105	Marketing Principles
27628	Law for Leisure, Sport and Tourism
27190	Professional Practice 2 – Project (cont.)
2xxxx	Bachelor of Arts in Human Movement Studies elective
2xxxx	Bachelor of Arts in Human Movement Studies elective

Further details of Human Movement Studies subjects may be found in the *Faculty of Business Handbook*. Alternatively, queries may be addressed to School of Leisure and Tourism Management Studies on 9514 5497. Queries regarding the International Studies component of the course should be addressed to the Institute itself on 9514 1574.

Combined degree students are required to confirm, during the University enrolment period, the subjects they intend to take for the year with the Institute at 9-11 Broadway (next door to the Co-op Bookshop).

Bachelor of Arts in Leisure Management and in International Studies

Course code: BL17

The Bachelor of Arts in Leisure Management and in International Studies is offered jointly by the Faculty of Business and the Institute for International Studies, UTS. The five-year full-time degree integrates Leisure Management with a major in the language and culture of another country. Students spend the fourth year of study at a university overseas.

Admission requirements

Admission to the combined degree will be on merit according to the admissions policy for the Bachelor of Arts in Leisure Management. There are no prior language requirements for the International Studies component of this combined degree, however, some majors within the International Studies program do have specific admission requirements. Entry to the Greece, Poland, Slovenia and Ukraine majors is restricted to students who have a sound working knowledge of the language of their selected specialisation. Study of Language and Culture depends on the individual student's level of language proficiency before entry to the program. There is a range of entry levels to the various

Language and Culture programs. Students are admitted to the International Studies program with no guarantee of entry to a specific major, although every effort is made in trying to meet students preferences.

Arrangements for In-country Study

All students are required to complete four consecutive semesters of study of language and culture before proceeding to In-country Study.

The costs of tuition in host institutions overseas and travel between Sydney and the designated host institutions are borne by UTS except in cases where a scholarship has been awarded to the student with provision for these costs. Under those circumstances, the funds that would have otherwise been allocated towards the student's tuition and travel will be redirected to support the In-country Study program in general. In most cases the cost of living for the period of In-country Study will not exceed the cost of living away from home in Sydney. However, students should be aware that the cost of living in some countries – notably Argentina, France, Germany, Hong Kong, Japan and Taiwan – may be higher than in Sydney.

Course structure

All students must complete 240 credit points of study comprising 144 credit points relating to the Bachelor of Arts in Leisure Management and 96 credit points relating to the Bachelor of Arts in International Studies.

In the International Studies component, students choose one of the following specialisations – Argentina, Chile, China, Croatia, France, Germany, Greece, Indonesia, Italy, Japan, Latin America, Malaysia, Mexico, Poland, Russia, Slovenia, South China, South-East Asia, Taiwan, Thailand or Ukraine. Australia and the Asia-Pacific Region is available as a major to international students.

Each major includes 32 credit points (four x 8cp subjects) of instruction in Language and Culture; 8 credit points of study of Modernisation and Social Change; 8 credit points of study of Contemporary Society; and 48 credit points (two semesters) of study at an institution of higher education in a country of the major.

Course program

Semester 1

- 27126 Leisure in Australia
 27189 Professional Practice 1
 27187 Leisure Concepts
 023504 Introduction to Developmental and Educational Psychology
 25222 Applied Economics

Semester 2

- 21130 Management and Organisations
 22028 Accounting for Managers
 27186 Leisure and Human Movement in Social Context
 27106 Social Psychology of Leisure
 27326 Leisure and Specific Populations
 27189 Professional Practice 1 (cont.)

Semester 3

- 27179 Festivals and Special Events
 27156 Research Methods 1
 971xxx Language and Culture 1
 50140 Modernisation and Social Change

Semester 4

- 27323 Leisure and Public Policy
 27157 Research Methods 2
 972xxx Language and Culture 2
 27216 Leisure Services Management

Semester 5

- 24105 Marketing Principles
 973xxx Language and Culture 3
 2xxxx BA in Leisure Management elective
 21555 Human Resource Management

Semester 6

- 974xxx Language and Culture 4
 976xxx Contemporary Society
 2xxxx BA in Leisure Management elective
 2xxxx BA in Leisure Management elective

Semester 7

- 977xxx In-country Study 1

Semester 8

- 978xxx In-country Study 2

Semester 9

- 27523 Leisure and Tourism Planning
 27526 Leisure Theory
 27190 Professional Practice 2 – Project
 27606 Contemporary Issues in Leisure
 2xxxx BA in Leisure Management elective

Semester 10

- 27628 Law for Leisure, Sport and Tourism
 27606 Contemporary Issues in Leisure (cont.)
 27190 Professional Practice 2 – Project (cont.)

2xxxx BA in Leisure Management elective

2xxxx BA in Leisure Management elective

Further details of Leisure Management subjects may be found in the *Faculty of Business Handbook*. Alternatively, queries may be addressed to the School of Leisure and Tourism Studies on 9514 5497. Queries regarding the International Studies component of the course should be addressed to the Institute itself on 9514 1574.

Combined degree students are required to confirm, during the University enrolment period, the subjects they intend to take for the year with the Institute at 9-11 Broadway (next door to the Co-op Bookshop).

Bachelor of Arts in Tourism Management and in International Studies

Course code: BL16

The Bachelor of Arts in Tourism Management and in International Studies is offered jointly by the Faculty of Business and the Institute for International Studies, UTS. The five-year full-time degree integrates the study of Tourism Management with a major in the language and culture of another country. Students spend the fourth year of study at a university overseas.

Admission requirements

Admission to the combined degree will be on merit according to the admissions policy for the Bachelor of Arts in Tourism Management. There are no prior language requirements for the International Studies component of this combined degree, however, some majors within the International Studies program do have specific admission requirements. Entry to the Greece, Poland, Slovenia and Ukraine majors is restricted to students who have a sound working knowledge of the language of their selected specialisation. Study of Language and Culture depends on the individual student's level of language proficiency before entry to the program. There is a range of entry levels to the various Language and Culture programs. Students are admitted to the International Studies program with no guarantee of entry to a specific major, although every effort is made in trying to meet students preferences.

Arrangements for In-country Study

All students are required to complete four consecutive semesters of study of language and culture before proceeding to In-country Study.

The costs of tuition in host institutions overseas and travel between Sydney and the designated host institutions are borne by UTS except in cases where a scholarship has been awarded to the student with provision for these costs. Under those circumstances, the funds that would have otherwise been allocated towards the student's tuition and travel will be redirected to support the In-country Study program in general. In most cases the cost of living for the period of In-country Study will not exceed the cost of living away from home in Sydney. However, students should be aware that the cost of living in some countries – notably Argentina, France, Germany, Hong Kong, Japan and Taiwan – may be higher than in Sydney.

Course structure

All students must complete 240 credit points of study comprising 144 credit points relating to the Bachelor of Arts in Tourism Management and 96 credit points relating to the Bachelor of Arts in International Studies.

In the International Studies component, students choose one of the following specialisations – Argentina, Chile, China, Croatia, France, Germany, Greece, Indonesia, Italy, Japan, Latin America, Malaysia, Mexico, Poland, Russia, Slovenia, South China, South-East Asia, Spain, Taiwan, Thailand and Ukraine. Australia and the Asia-Pacific Region is available as a major to international students.

Each major includes 32 credit points (four x 8cp subjects) of instruction in Language and Culture; 8 credit points of study of Modernisation and Social Change; 8 credit points of study of Contemporary Society; and 48 credit points (two semesters) of study at an institution of higher education in a country of the major.

Course program

Semester 1

27184	Introduction to Tourism Systems
27648	The Tourism Industry
27187	Leisure Concepts
22105	Accounting A
25222	Applied Economics

Semester 2

27644	Hospitality Operations 1 <i>and</i>
27654	Hospitality Operations 2 <i>or</i>
27643	Travel and Tourism Operations 1 <i>and</i>
27653	Travel and Tourism Operations 2
27185	Introduction to Tourist Behaviour
22205	Accounting B
21130	Management and Organisations

Semester 3

27327	Tourism's Environmental Interactions
27156	Research Methods 1
971xxx	Language and Culture 1
50140	Modernisation and Social Change
27163	Tourism Industry Practicum

Semester 4

24105	Marketing Principles
27323	Leisure and Public Policy
27157	Research Methods 2
972xxx	Language and Culture 2
27163	Tourism Industry Practicum (cont.)

Semester 5

27164	Tourism Services Management
21555	Human Resource Management
973xxx	Language and Culture 3
27523	Leisure and Tourism Planning

Semester 6

974xxx	Language and Culture 4
976xxx	Contemporary Society
27642	Tourism Services Marketing

Semester 7

977xxx	In-country Study 1
--------	--------------------

Semester 8

978xxx	In-country Study 2
--------	--------------------

Semester 9

27165	Tourism Studies Project 1
2xxxx	BA in Tourism Management elective
2xxxx	BA in Tourism Management elective
2xxxx	BA in Tourism Management elective

Semester 10

27167	Tourist Destination Marketing and Management
27166	Tourism Studies Project 2
2xxxx	BA in Tourism Management elective
27628	Law for Leisure, Sport and Tourism

Further details of Tourism Management subjects may be found in the *Faculty of Business Handbook*. Alternatively, queries may be addressed to the School of Leisure and Tourism Studies on 9514 5497. Queries regarding the International Studies component of the course should be addressed to the Institute itself on 9514 1574.

Combined degree students are required to confirm, during the University enrolment period, the subjects they intend to take for the year with the Institute at 9-11 Broadway (next door to the Co-op Bookshop).

Bachelor of Building in Construction Economics/ Bachelor of Arts in International Studies

Course code: AB08

The Bachelor of Building in Construction Economics and Bachelor of Arts in International Studies is a six-year degree program combining the Bachelor of Building in Construction Economics program with the University's Bachelor of Arts in International Studies.

The Construction Economics degree program provides quantity surveying education in applied economics for the construction industry, and leads to a professional qualification in quantity surveying. Quantity surveyors provide financial and economic advice relating to the cost management of projects from the time of their conception throughout the design, construction and deployment phases. The aim of the combined degree is to provide graduates not only with those skills, but also the ability to deal with other languages and cultures, both within Australia and internationally.

Course structure

Students are required to undertake periods of approved industrial training. The degree may be conferred with First or Second Class Honours for meritorious performance.

Construction Economics covers all the important areas within the discipline and has a clear economic bias. A range of topics are dealt with including quantity surveying, economics, law, design, computing, management, materials science, estimating, construction and services.

The construction subjects are a core element of the course and are undertaken in conjunction with the Construction Management program. Students are required to undertake practical studies as part of these subjects which typically involve field work or simulated office practice.

The Bachelor of Arts in International Studies requires undergraduates to study a major – a region or country of specialisation – over a minimum of three years. In Sydney students study Language and Culture for at least two years, followed by a period of study overseas.

The following majors are available: Argentina, Chile, China, Croatia, France, Germany, Greece, Indonesia, Italy, Japan, Latin America, Malaysia, Mexico, Poland, Russia, Slovenia, South China, South-East Asia, Spain, Taiwan, Thailand and Ukraine. The Greece, Poland, Slovenia and Ukraine specialisations are only available to students with a sound working knowledge of the language of their selected specialisation.

Australia and the Asia-Pacific Region is available as a major to international students.

Each of the specialisations within the International Studies program is 96 credit points, and includes 32 credit points (four subjects) of instruction in Language and Culture; 8 credit points of study of Modernisation and Social Change; 8 credit points of study of Contemporary Society; and 48 credit points (two semesters) of study at an institution of higher education in a country of the major.

Those who have not previously studied a language and culture other than English are as able to complete this program as those who have.

Arrangements for In-country Study

All students are required to complete four consecutive semesters of study of Language and Culture before proceeding to In-country Study. There are different classes available for students according to their level of language proficiency.

The Institute for International Studies makes arrangements for students to spend two semesters of In-country Study at an institution of higher education in the country of their major. The costs of tuition in host institutions overseas and travel between Sydney and the designated host institutions are borne by UTS except in cases where a scholarship has been awarded to the student with provision for these costs. Under those circumstances, the funds that would have otherwise been allocated towards the student's tuition and travel will be redirected to support the In-country Study program in general. In most cases the cost of living for the period of In-country Study will not exceed the cost of living away from home in Sydney. However, students should be aware that the cost of living in some countries – notably Argentina, France, Germany, Hong Kong, Japan and Taiwan – may be higher than in Sydney.

Course program

Year 1

16001	Preparatory Studies	8cp
16115	Construction 1	8cp
16721	Materials Science	8cp
50140	Modernisation and Social Change (Autumn semester)	8cp
976xx	Contemporary Society (Spring semester)	8cp
16621	Design Evaluation	8cp

Year 2

16161	Statistics	8cp
16116	Construction 2	8cp
971xxx	Language and Culture 1 (Autumn semester)	8cp
972xxx	Language and Culture 2 (Spring semester)	8cp
16501	Quantity Surveying 1	8cp
16622	Environmental Planning	8cp

Year 3

16502	Quantity Surveying 2	8cp
16805	Legal Studies 1	8cp
xxxxx	Estimating	8cp
973xxx	Language and Culture 3 (Autumn semester)	8cp
974xxx	Language and Culture 4 (Spring semester)	8cp
16310	Engineering Services	8cp

Year 4

977xxx	In-country Study 1 (Autumn semester)	24cp
978xxx	In-country Study 2 (Spring semester)	24cp

Year 5

16521	Cost Planning and Modelling	8cp
16117	Construction 3	8cp
16806	Legal Studies 2	8cp
16534	Project Planning and Risk	8cp
16522	Economic Development	8cp
16503	Quantity Surveying 3	8cp

Year 6

16411	Contract Administration	8cp
16118	Construction 4	8cp
16523	Advanced Cost Engineering	8cp
16513	Economic Analysis	8cp
16506	Quantity Surveying Practice*	8cp
xxxxx	Electives*	8cp

*Final Year Alternative

16224	Quantity Surveying Project	12cp
xxxxx	Elective	4cp

Further details of Construction Economics subjects may be found in the *Faculty of Design, Architecture and Building Handbook*. Queries regarding the International Studies component of the course should be addressed to the Institute itself on 9514 1574.

Combined degree students are required to confirm, during the University enrolment period, the subjects they intend to take for the year with the Institute at 9-11 Broadway (next door to the Co-op Bookshop).

Bachelor of Building in Construction Management/Bachelor of Arts in International Studies

Course code: AB09

The Bachelor of Building in Construction Management/Bachelor of Arts in International Studies is a six-year degree program in which Construction Management studies are combined with International Studies. The Building graduate is concerned with management of construction and building projects. Extensive technological skills are required alongside the capacity to manage people, materials, equipment and plant in order to carry out this task as effectively as possible. The aim of the combined degree in Construction Management and International Studies is to produce graduates who have not only those skills but also developed perspectives and understandings that will enable them to meet the demands of an internationalised professional environment.

The combined degree program in Building in Construction Management and International Studies provides students specialising in Construction Management with additional practical skills by providing the opportunity to acquire knowledge and understanding of a language and culture other than English.

Course structure

To graduate a student is required to have completed 288 credit points: 192 credit points in Construction Management; and 96 credit points in International Studies. Students are also required to undertake periods of approved industrial training. The degree may be conferred with First or Second Class Honours for meritorious performance.

Construction Management concerns the management of the construction stage of building projects on time, within estimated cost targets and to the level of quality established in the contract documents, and fulfilling the needs of the community. The course focuses on resource and site management but also covers areas such as materials, structures, services, estimating, law, economics and construction technology.

Students are required to undertake practical studies as part of these subjects which typically involve field work or simulated office practice.

The Bachelor of Arts in International Studies requires undergraduates to study a major – a region or country of specialisation – over a minimum of three years. In Sydney students study Language and Culture for at least two years, followed by a period of study overseas.

The following majors are available: Argentina, Chile, China, Croatia, France, Germany, Greece, Indonesia, Italy, Japan, Latin America, Malaysia, Mexico, Poland, Russia, Slovenia, South China, South-East Asia, Spain, Taiwan, Thailand and Ukraine. The Greece, Poland, Slovenia and Ukraine specialisations are only available to students with a sound working knowledge of the language of their selected specialisation.

Australia and the Asia-Pacific Region is available as a major to international students.

Each of the specialisations within the International Studies program is 96 credit points, and includes 32 credit points (four subjects) of instruction in Language and Culture; 16 credit points (two subjects) of study of Contemporary Society; and 48 credit points (two semesters) of study at a university or institution of higher education in the culture of specialisation.

Those who have not previously studied a language and culture other than English are as able to complete this program as those who have.

Arrangements for In-country Study

All students are required to complete four consecutive semesters of study of Language and Culture before proceeding to In-country Study. There are different classes available for students according to their level of language proficiency.

The Institute for International Studies makes arrangements for students to spend two semesters of In-country Study at an institution of higher education in a country of their major. The costs of tuition in host institutions overseas and travel between Sydney and the designated host institutions are borne by UTS except in cases where a scholarship has been awarded to the student with provision for these costs. Under those circumstances, the funds that would have otherwise been allocated towards the student's tuition and travel will be redirected to support the In-country Study program in general. In most cases the cost of living for the period of In-country Study will not exceed the cost of living away from home

in Sydney. However, students should be aware that the cost of living in some countries – notably Argentina, France, Germany, Hong Kong, Japan and Taiwan – may be higher than in Sydney.

Course program

Year 1

16201	Drawing and Surveying 1	4cp
16111	Construction 1	8cp
16101	Construction Project 1	8cp
16901	Structures 1	6cp
16407	Building Communications	6cp
50140	Modernisation and Social Change (Autumn semester)	8cp
976xxx	Contemporary Society (Spring semester)	8cp

Year 2

16211	Computations	6cp
16112	Construction 2	8cp
16543	Quantities	6cp
16301	Services 1	6cp
971xxx	Language and Culture 1	8cp
972xxx	Language and Culture 2	8cp
16725	Materials Science 1	6cp

Year 3

16202	Drawing and Surveying 2	6cp
16020	Construction Project 2	8cp
16902	Structures 2	6cp
16807	Introduction to Law	6cp
16531	Estimating 1	6cp
973xxx	Language and Culture 3	8cp
974xxx	Language and Culture 4	8cp

Year 4

977xxx	In-country Study 1 (Autumn semester)	24cp
978xxx	In-country Study 2 (Spring semester)	24cp

Year 5

16515	Building Company Performance	6cp
16516	Development Appraisal	4cp
16726	Materials Science 2	6cp
16903	Structures 3	6cp
16030	Construction Project 3	8cp
16113	Construction 3	8cp
16302	Services 2	4cp
16808	Construction Law	6cp

Year 6

16040	Construction Project 4	8cp
16131	Professional Practice	4cp
16621	Graduating Project	12cp
16114	Construction 4	8cp
xxxxx	Elective(s)	8cp
16532	Estimating 2	8cp

Further details of Construction Management subjects may be found in the *Faculty of Design, Architecture and Building Handbook*. Queries regarding the International Studies component of the course should be addressed to the Institute itself on 9514 1574.

Combined degree students are required to confirm, during the University enrolment period, the subjects they intend to take for the year with the Institute at 9-11 Broadway (next door to the Co-op Bookshop).

Bachelor of Design in Fashion and Textile Design/Bachelor of Arts in International Studies

Course code: DF03

Fashion and textile design is concerned with the design of fashion clothing, surface and textiles, their related fields and technologies.

The aim of the combined degree in Fashion and Textile Design and International Studies is to produce graduates who have developed perspectives and understandings that will enable them to meet the professional demands of an internationalised marketplace.

The Bachelor of Design in Fashion and Textile Design and Bachelor of Arts in International Studies is a six-year degree in which the study of Fashion and Textile Design is integrated with a major in the language and culture of another country. Students spend the fourth year of study at a university overseas.

The combined degree program in Fashion and Textile Design and International Studies provides students with additional practical skills, in particular those that make them aware of the international contexts of fashion and textile design by providing the opportunity to acquire knowledge and understanding of a language and culture other than English.

Course structure

The Bachelor of Design in Fashion and Textile Design curriculum is based on a problem-solving approach and self-directed learning. Students take a common first semester of multidisciplinary study. Fashion and Textile Design studies commence in the second semester and focus on core design fundamentals of both fashion and textiles, with a strong base of technology across both disciplines. All students are required to gain

practical experience in professional design practice to augment and complement their academic studies.

The Bachelor of Arts in International Studies requires undergraduates to study a major – a region or country specialisation – over a minimum of three years. In Sydney students study language and culture for at least two years, followed by a period of study overseas. The following range of majors is available: Argentina, Chile, China, Croatia, France, Germany, Greece, Indonesia, Italy, Japan, Latin America, Malaysia, Mexico, Poland, Russia, Slovenia, South China, South-East Asia, Spain, Taiwan, Thailand and Ukraine. The Greece, Poland, Slovenia and Ukraine specialisations are only available to students with a sound working knowledge of the language of their selected specialisation.

Australia and the Asia-Pacific Region is available as a major to international students.

Each of the specialisations within the International Studies program is 96 credit points, and includes 32 credit points (four subjects) of instruction in Language and Culture; 16 credit points (two subjects) of study of Contemporary Society; and 48 credit points (two semesters) of study at a university or institution of higher education in the country or region of specialisation.

Those who have not previously studied a language and culture other than English are as able to complete this program as those who have.

Arrangements for In-country Study

All students are required to complete four consecutive semesters of study of Language and Culture before proceeding to In-country Study. There are different classes available for students according to their level of language proficiency.

The Institute for International Studies makes arrangements for students to spend two semesters of In-country Study at an institution of higher education in a country of their major. The costs of tuition in host institutions overseas and travel between Sydney and the designated host institutions are borne by UTS except in cases where a scholarship has been awarded to the student with provision for these costs. Under those circumstances, the funds that would have otherwise been allocated towards the student's tuition and travel will be redirected to support the

In-country Study program in general. In most cases the cost of living for the period of In-country Study will not exceed the cost of living away from home in Sydney. However, students should be aware that the cost of living in some countries – notably Argentina, France, Germany, Hong Kong, Japan and Taiwan – may be higher than in Sydney.

Course program

Year 1

Stage 1

85000 Design 1 24cp

Stage 2

83220 Design Project Fashion and Textiles 2 24cp

Year 2

Stage 3

xxxxx Minor study 6cp

xxxxx General study 4cp

971xxx Language and Culture 1 8cp

50140 Modernisation and Social Change 8cp

Stage 4

xxxxx Minor study 6cp

xxxxx General study 4cp

972xxx Language and Culture 2 8cp

976xxx Contemporary Society 8cp

Year 3

Stage 5

83330 Design Project Fashion and Textiles 3 14cp

973xxx Language and Culture 3 8cp

Stage 6

83440 Design Project Fashion and Textiles 4 14cp

974xxx Language and Culture 4 8cp

Year 4

Stage 7

977xxx In-country Study 1 24cp

Stage 8

978xxx In-country Study 2 24cp

Year 5

Stage 9

83550 Design Project Fashion and Textiles 5 14cp

xxxxx Minor study 6cp

xxxxx General study 4cp

Stage 10

83660 Design Project Fashion and Textiles 6 14cp

xxxxx Minor study 6cp

xxxxx General study 4cp

Year 6

Stage 11

83770 Design Project Fashion and Textiles 7 16cp
 83780 Research Dissertation F&T 8cp

Stage 12

83880 Major Project Fashion and Textiles 24cp

Further details of Fashion and Textile Design subjects may be found in the *Faculty of Design, Architecture and Building Handbook*. Queries regarding the International Studies component of the course should be addressed to the Institute itself on 9514 1574.

Combined degree students are required to confirm, during the University enrolment period, the subjects they intend to take for the year with the Institute at 9-11 Broadway (next door to the Co-op Bookshop).

Bachelor of Design in Interior Design/Bachelor of Arts in International Studies

Course code: DT02

Interior design is concerned with the design of all facets of the interior environment in response to the particular human activities occurring within. The interior designer works with the building construction and product supply industries to create interior environments for specific purposes.

The aim of the combined degree in Interior Design and International Studies is to produce graduates who have developed perspectives and understandings that will enable them to meet the professional demands of an internationalised marketplace.

The Bachelor of Design in Interior Design and Bachelor of Arts in International Studies is a six-year degree in which the study of Interior Design is integrated with a major in the language and culture of another country. Students spend the fourth year of study at a university overseas.

The combined degree program in Interior Design and International Studies provides students with additional practical skills, in particular those that make them aware of the international contexts of Interior Design by providing the opportunity to acquire knowledge and understanding of a language and culture other than English.

Course structure

The Bachelor of Design in Interior Design curriculum is based on a problem-solving approach and self-directed learning. Students take a common first semester of multidisciplinary study. Interior Design studies commence in the second semester and focus on core design fundamentals of interior design, with a strong base of technology. All students are required to gain practical experience in professional design practice to augment and complement their academic studies.

The Bachelor of Arts in International Studies requires undergraduates to study a major – a region or country specialisation – over a minimum of three years. In Sydney, students study language and culture for at least two years, followed by a period of study overseas. The following range of majors is available: Argentina, Chile, China, Croatia, France, Germany, Greece, Indonesia, Italy, Japan, Latin America, Malaysia, Mexico, Poland, Russia, Slovenia, South China, South-East Asia, Spain, Taiwan, Thailand and Ukraine. The Greece, Poland, Slovenia and Ukraine specialisations are only available to students with a sound working knowledge of the language of their selected specialisation.

Australia and the Asia-Pacific Region is available as a major to international students.

Each of the specialisations within the International Studies program is 96 credit points, and includes 32 credit points (four subjects) of instruction in Language and Culture; 16 credit points (two subjects) of study of Contemporary Society; and 48 credit points (two semesters) of study at a university or institution of higher education in the country or region of specialisation.

Those who have not previously studied a language and culture other than English are as able to complete this program as those who have.

Arrangements for In-country Study

All students are required to complete four consecutive semesters of study of Language and Culture before proceeding to In-country Study. There are different classes available for students according to their level of language proficiency.

The Institute for International Studies makes arrangements for students to spend two

semesters of In-country Study at an institution of higher education in a country of their major. The costs of tuition in host institutions overseas and travel between Sydney and the designated host institutions are borne by UTS except in cases where a scholarship has been awarded to the student with provision for these costs. Under those circumstances, the funds that would have otherwise been allocated towards the student's tuition and travel will be redirected to support the In-country Study program in general. In most cases, the cost of living for the period of In-country Study will not exceed the cost of living away from home in Sydney. However, students should be aware that the cost of living in some countries – notably Argentina, France, Germany, Hong Kong, Japan and Taiwan – may be higher than in Sydney.

Course program

Year 1

Stage 1

85000 Design 1 24cp

Stage 2

86220 Design Project Interior Design (IT) 2 24cp

Year 2

Stage 3

xxxxx Minor study 6cp

xxxxx General study 4cp

971xxx Language and Culture 1 8cp

50140 Modernisation and Social Change 8cp

Stage 4

xxxxx Minor study 6cp

xxxxx General study 4cp

972xxx Language and Culture 2 8cp

976xxx Contemporary Society 8cp

Year 3

Stage 5

86330 Design Project IT 3 14cp

973xxx Language and Culture 3 8cp

Stage 6

86440 Design Project IT 4 14cp

974xxx Language and Culture 4 8cp

Year 4

Stage 7

977xxx In-country Study 1 24cp

Stage 8

978xxx In-country Study 2 24cp

Year 5

Stage 9

86550 Design Project IT 5 14cp

xxxxx Minor study 6cp

xxxxx General study 4cp

Stage 10

86660 Design Project IT 6 14cp

xxxxx Minor study 6cp

xxxxx General study 4cp

Year 6

Stage 11

86770 Design Project IT 7 16cp

86780 Research Dissertation IT 8cp

Stage 12

86880 Major Project IT 24cp

Further details of Interior Design subjects may be found in the *Faculty of Design, Architecture and Building Handbook*. Queries regarding the International Studies component of the course should be addressed to the Institute itself on 9514 1574.

Combined degree students are required to confirm, during the University enrolment period, the subjects they intend to take for the year with the Institute at 9-11 Broadway (next door to the Co-op Bookshop).

Bachelor of Design in Industrial Design/ Bachelor of Arts in International Studies

Course code: *DD02*

Industrial design is concerned with the design of products for the manufacturing industry. The industrial designer works with manufacturers and has the responsibility not only for the visual and tactile qualities of products but also to a large extent for their safety, efficiency and cost effectiveness.

The aim of the combined degree in Industrial Design and International Studies is to produce graduates who have developed perspectives and understandings that will enable them to meet the professional demands of an internationalised marketplace.

The Bachelor of Design in Industrial Design and Bachelor of Arts in International Studies is a six-year degree in which the study of Industrial Design is integrated with a major in the language and culture of another country. Students spend the fourth year of study at a university overseas.

The combined degree program in Industrial Design and International Studies provides students with additional practical skills, in particular those that make them aware of the international contexts of Industrial Design by providing the opportunity to acquire knowledge and understanding of a language and culture other than English.

Course structure

The Bachelor of Design in Industrial Design curriculum is based on a problem-solving approach and self-directed learning. Students take a common first semester of multidisciplinary study. Industrial Design studies commence in the second semester and focus on core design fundamentals of industrial design with a strong base of technology. All students are required to gain practical experience in professional design practice to augment and complement their academic studies.

The Bachelor of Arts in International Studies requires undergraduates to study a major – a region or country specialisation – over a minimum of three years. In Sydney, students study language and culture for at least two years, followed by a period of study overseas.

The following range of majors is available: Argentina, Chile, China, Croatia, France, Germany, Greece, Indonesia, Italy, Japan, Latin America, Malaysia, Mexico, Poland, Russia, Slovenia, South China, South-East Asia, Spain, Taiwan, Thailand and Ukraine. The Greece, Poland, Slovenia and Ukraine specialisations are only available to students with a sound working knowledge of the language of their selected specialisation.

Australia and the Asia-Pacific Region is available as a major to international students.

Each of the specialisations within the International Studies program is 96 credit points, and includes 32 credit points (four subjects) of instruction in Language and Culture; 16 credit points (two subjects) of study of Contemporary Society; and 48 credit points (two semesters) of study at a university or institution of higher education in the country or region of specialisation.

Those who have not previously studied a language and culture other than English are as able to complete this program as those who have.

Arrangements for In-country Study

All students are required to complete four consecutive semesters of study of Language and Culture before proceeding to In-country Study. There are different classes available for students according to their level of language proficiency.

The Institute for International Studies makes arrangements for students to spend two semesters of In-country Study at an institution of higher education in a country of their major. The costs of tuition in host institutions overseas and travel between Sydney and the designated host institutions are borne by UTS except in cases where a scholarship has been awarded to the student with provision for these costs. Under those circumstances, the funds that would have otherwise been allocated towards the student's tuition and travel will be redirected to support the In-country Study program in general. In most cases the cost of living for the period of In-country Study will not exceed the cost of living away from home in Sydney. However, students should be aware that the cost of living in some countries – notably Argentina, France, Germany, Hong Kong, Japan and Taiwan – may be higher than in Sydney.

Course program

Year 1

Stage 1

85000 Design 1 24cp

Stage 2

84220 Design Project Industrial
Design (ID) 2 24cp

Year 2

Stage 3

xxxxx Minor study 6cp

xxxxx General study 4cp

971xxx Language and Culture 1 8cp

50140 Modernisation and Social Change 8cp

Stage 4

xxxxx Minor study 6cp

xxxxx General study 4cp

972xxx Language and Culture 2 8cp

976xxx Contemporary Society 8cp

Year 3

Stage 5

84330 Design Project ID 3 14cp

973xxx Language and Culture 3 8cp

Stage 6

84440 Design Project ID 4 14cp

974xxx Language and Culture 4 8cp

Year 4

Stage 7

977xxx In-country Study 1 24cp

Stage 8

978xxx In-country Study 2 24cp

Year 5

Stage 9

84550 Design Project ID 5 14cp

xxxxx Minor study 6cp

xxxxx General study 4cp

Stage 10

84660 Design Project ID 6 14cp

xxxxx Minor study 6cp

xxxxx General study 4cp

Year 6

Stage 11

84770 Design Project ID 7 16cp

84780 Research Dissertation ID 8cp

Stage 12

84880 Major Project ID 24cp

Further details of Industrial Design subjects may be found in the *Faculty of Design, Architecture and Building Handbook*. Queries regarding the International Studies component of the course should be addressed to the Institute itself on 9514 1574.

Combined degree students are required to confirm, during the University enrolment period, the subjects they intend to take for the year with the Institute at 9-11 Broadway (next door to the Co-op Bookshop).

Bachelor of Design in Visual Communication/ Bachelor of Arts in International Studies

Course code: DV02

Design of visual communication involves the creation, processing and production of messages in a visual form. Designers in this area are employed to use their creativity and knowledge to determine the optimum effectiveness of the message, visually communicated to a selected group of people. The message may be designed to instruct, direct, inform, entertain or persuade, most often incorporating words and images produced freehand or with the assistance of photographic, video and digital technologies. In visual communication, designed messages are reproduced or transmitted to the end user/viewer through print or screen media.

The aim of the combined degree in Visual Communication and International Studies is to produce graduates who have developed perspectives and understandings that will enable them to meet the professional demands of an internationalised marketplace.

The Bachelor of Design in Visual Communication and Bachelor of Arts in International Studies is a six-year degree in which the study of Visual Communication is integrated with a major in the language and culture of another country. Students spend the fourth year of study at a university overseas.

The combined degree program in Visual Communication and International Studies provides students with additional practical skills, in particular those that make them aware of the international contexts of Visual Communication by providing the opportunity to acquire knowledge and understanding of a language and culture other than English.

Course structure

The Bachelor of Design in Visual Communication curriculum is based on a problem-solving approach and self-directed learning. Students take a common first semester of multidisciplinary study. Visual Communication studies commence in the second semester and integral to the course is an understanding of the way the design process is mediated by the contemporary sociopolitical framework within which it occurs. All students are required to gain practical experience in professional design practice to augment and complement their academic studies.

The Bachelor of Arts in International Studies requires undergraduates to study a major – a region or country specialisation – over a minimum of three years. In Sydney, students study language and culture for at least two years, followed by a period of study overseas. The following range of majors is available: Argentina, Chile, China, Croatia, France, Germany, Greece, Indonesia, Italy, Japan, Latin America, Malaysia, Mexico, Poland, Russia, Slovenia, South China, South-East Asia, Spain, Taiwan, Thailand and Ukraine. The Greece, Poland, Slovenia and Ukraine specialisations are only available to students with a sound working knowledge of the language of their selected specialisation.

Australia and the Asia-Pacific Region is available as a major to international students.

Each of the specialisations within the International Studies program is 96 credit points, and includes 32 credit points (four subjects) of instruction in Language and Culture; 16 credit points (two subjects) of study of Contemporary Society; and 48 credit points (two semesters) of study at a university or institution of higher education in the country or region of specialisation.

Those who have not previously studied a language and culture other than English are as able to complete this program as those who have.

Arrangements for In-country Study

All students are required to complete four consecutive semesters of study of Language and Culture before proceeding to In-country Study. There are different classes available for students according to their level of language proficiency.

The Institute for International Studies makes arrangements for students to spend two semesters of In-country Study at an institution of higher education in a country of their major. The costs of tuition in host institutions overseas and travel between Sydney and the designated host institutions are borne by UTS except in cases where a scholarship has been awarded to the student with provision for these costs. Under those circumstances, the funds that would have otherwise been allocated towards the student’s tuition and travel will be redirected to support the In-country Study program in general. In most cases, the cost of living for the period of In-country Study will not exceed the cost of living away from home in Sydney. However, students should be aware that the cost of living in some countries – notably Argentina, France, Germany, Hong Kong, Japan and Taiwan – may be higher than in Sydney.

Course program

Year 1

Stage 1

85000 Design 1 24cp

Stage 2

87220 Design Project Visual Communication (VC) 2 24cp

Year 2

Stage 3

xxxxx Minor study 6cp

xxxxx General study 4cp

971xxx Language and Culture 1 8cp

50140 Modernisation and Social Change 8cp

Stage 4

xxxxx Minor study 6cp

xxxxx General study 4cp

972xxx Language and Culture 2 8cp

976xxx Contemporary Society 8cp

Year 3

Stage 5

87330 Design Project VC 3 14cp

973xxx Language and Culture 3 8cp

Stage 6

87440 Design Project VC 4 14cp

974xxx Language and Culture 4 8cp

Year 4

Stage 7

977xxx In-country Study 1 24cp

Stage 8

978xxx In-country Study 2 24cp

Year 5

Stage 9

87550 Design Project VC 5 14cp

xxxxx Minor study 6cp

xxxxx General study 4cp

Stage 10

87660 Design Project VC 6 14cp

xxxxx Minor study 6cp

xxxxx General study 4cp

Year 6

Stage 11

87770 Design Project VC 7 16cp

87780 Research Dissertation VC 8cp

Stage 12

87880 Major Project VC 24cp

Further details of Visual Communication subjects may be found in the *Faculty of Design, Architecture and Building Handbook*. Queries regarding the International Studies component of the course should be addressed to the Institute itself on 9514 1574.

Combined degree students are required to confirm, during the University enrolment period, the subjects they intend to take for the year with the Institute at 9-11 Broadway (next door to the Co-op Bookshop).

Bachelor of Land Economics/Bachelor of Arts in International Studies

Course code: AB10

The Bachelor of Land Economics/Bachelor of Arts in International Studies is a six-year degree which aims to produce broadly educated graduates prepared for careers in the property industry, and to equip students with an understanding of the legalities, principles and processes required in those professional careers. The combined degree program in Land Economics and International Studies will provide graduates not only with the necessary skills in those areas of expertise, but also develop perspectives and understandings that will enable them to meet the demands of an internationalised professional environment.

The course leads to award of a Bachelor of Land Economics degree that is granted with Honours where a high standard has been achieved. The degree, as awarded by UTS, is the professionally accepted qualification for employment as a land economist, valuer and real estate agent, on-site residential property manager, business agent and stock and station agent.

The combined degree program in Land Economics and International Studies provides students specialising in Land Economics with additional practical skills by providing the opportunity to acquire knowledge and understanding of a language and culture other than English.

Course structure

To graduate a student is required to have completed 264 credit points: 168 credit points in Land Economics; and 96 credit points in International Studies.

The Bachelor of Arts in International Studies requires undergraduates to study a major – a region or country specialisation – over a minimum of three years. In Sydney students study Language and Culture for at least two years, followed by a period of study overseas. The following range of majors is available: Argentina, Chile, China, Croatia, France, Germany, Greece, Indonesia, Italy, Japan, Latin America, Malaysia, Mexico, Poland, Russia, Slovenia, South China, South-East Asia, Spain, Taiwan, Thailand and Ukraine. The Greece, Poland, Slovenia and Ukraine

specialisations are only available to students with a sound working knowledge of the language of their selected specialisation.

Australia and the Asia-Pacific Region is available as a major to international students.

Each of the specialisations within the International Studies program is 96 credit points, and includes 32 credit points (four subjects) of instruction in Language and Culture; 16 credit points (two subjects) of study of Contemporary Society; and 48 credit points (two semesters) of study at a university or institution of higher education in the culture of specialisation.

Those who have not previously studied a language and culture other than English are as able to complete this program as those who have.

Arrangements for In-country Study

All students are required to complete four consecutive semesters of study of Language and Culture before proceeding to In-country Study. There are different classes available for students according to their level of language proficiency.

The Institute for International Studies makes arrangements for students to spend two semesters of In-country Study at an institution of higher education in a country of their major. The costs of tuition in host institutions overseas and travel between Sydney and the designated host institutions are borne by UTS except in cases where a scholarship has been awarded to the student with provision for these costs. Under those circumstances, the funds that would have otherwise been allocated towards the student's tuition and travel will be redirected to support the In-country Study program in general. In most cases the cost of living for the period of In-country Study will not exceed the cost of living away from home in Sydney. However, students should be aware that the cost of living in some countries – notably Argentina, France, Germany, Hong Kong, Japan and Taiwan – may be higher than in Sydney.

Course program

Year 1		
16163	Appraisal and Statistics	8cp
16150	Land Studies 1	8cp
16351	Introduction to Valuation	6cp
16361	Real Estate 1	6cp

50140	Modernisation and Social Change (Autumn semester)	8cp
976xxx	Contemporary Society (Spring semester)	8cp

Year 2

16551	Economics	8cp
16352	Valuation Methodology	8cp
16552	Financial and Trust Accounting	6cp
16851	Introduction to Law	6cp
16652	Environmental Design	4cp
16998	Land Economics Experience	
971xxx	Language and Culture 1	8cp
972xxx	Language and Culture 2	8cp

Year 3

16152	Land Studies 2	4cp
16153	Building Technology	6cp
16354	Rural Valuation	6cp
16553	Finance and Investment Analysis	8cp
16854	Real Estate Law	4cp
16651	Urban Planning	4cp
16998	Land Economics Experience	
973xxx	Language and Culture 3	8cp
974xxx	Language and Culture 4	8cp

Year 4

977xxx	In-country Study 1	24cp
978xxx	In-country Study 2	24cp

Year 5

16155	Facility Evaluation	4cp
16355	Specialised Valuation Topics	8cp
16454	Investment and Portfolio Management	4cp
16453	Development Management and Maintenance	4cp
16456	Real Estate 2	8cp
16554	Urban Economics	8cp
16853	Planning and Environmental Law	4cp
16997	Land Economics Experience	

Year 6

16353	Advanced Valuation Methods	8cp
16751	International Real Estate Investment	6cp
16356	Statutory Valuation and Litigation	4cp
16452	Land Studies 3	4cp
16455	Real Estate 3	4cp
16961	Project	10cp
16997	Land Economics Experience	

Further details of Land Economics subjects may be found in the *Faculty of Design, Architecture and Building Handbook*. Queries regarding the International Studies component of the course should be addressed to the Institute itself on 9514 1574.

Combined degree students are required to confirm, during the University enrolment period, the subjects they intend to take for the year with the Institute at 9-11 Broadway (next door to the Co-op Bookshop).

Bachelor of Education/ Bachelor of Arts in International Studies

Course code: TE21

The combined degree in Education and International Studies aims to provide students with the professional education necessary for preparation for primary teaching while at the same time providing an opportunity to acquire knowledge and understanding of another language and culture.

The Bachelor of Education/Bachelor of Arts in International Studies is a five-year degree. Students spend the fourth year of study at a university overseas. All existing arrangements for both the Bachelor of Education and the Bachelor of Arts in International Studies apply equally to the combined degree program.

Admission requirements

Admission to the combined degree will be according to the admissions policy for the Bachelor of Education. There are no prior language requirements for the International Studies component of this combined degree, however, some majors within the International Studies program do have specific admission requirements. Entry to the Greece, Poland, Slovenia and Ukraine majors is restricted to students who have a sound working knowledge of the language of their selected specialisation. Students are admitted to the International Studies program with no guarantee of entry to a specific major, although every effort is made in trying to meet students preferences.

Students do not need to have previously studied a language and culture other than English to be able to successfully complete the program. There are different classes available for students with different levels of language proficiency.

Arrangements for In-country Study

All students are required to complete four consecutive semesters of study of language and culture before proceeding to In-country Study.

The costs of tuition in host institutions overseas and travel between Sydney and the designated host institutions are borne by UTS except in cases where a scholarship has been awarded to the student with provision for these costs.

Under those circumstances, the funds that would have otherwise been allocated towards the student's tuition and travel will be redirected to support the In-country Study program in general. In most cases the cost of living for the period of In-country Study will not exceed the cost of living away from home in Sydney. However, students should be aware that the cost of living in some countries – notably Argentina, France, Germany, Hong Kong, Japan and Taiwan – may be higher than in Sydney.

Course structure

To graduate, a student is required to have completed 240 credit points of study: 144 credit points in Teacher Education and 96 credit points in International Studies.

In the first year students undertake the same core Teacher Education program as other Bachelor of Education students. Then, in the second and third years, they continue their study of Teacher Education while studying a particular language and culture in preparation for spending their fourth year at a university overseas. The fifth year is spent completing the Teacher Education program.

The International Studies program requires undergraduates to study one major – a country or region of specialisation – over a minimum of three years. Each of the majors within the International Studies program has a value of 96 credit points, and includes 32 credit points (four subjects) of instruction in an appropriate Language and Culture; 8 credit points (one subject) on Modernisation and Social Change; 8 credit points (one subject) on Contemporary Society; and 48 credit points (two semesters) of study at a university or institution of higher education in a country of the major. The following majors are offered: Argentina, Chile, China, Croatia, France, Germany, Greece, Indonesia, Italy, Japan, Latin America, Malaysia, Mexico, Poland, Russia, Slovenia, South China, South-East Asia, Spain, Taiwan, Thailand and Ukraine.

Australia and the Asia-Pacific Region is available as a major to international students.

Each student's choice of major and subjects to study in the International Studies program requires the approval of the Board of Studies of the Institute for International Studies.

In exceptional circumstances, students may, with the approval of the Board of Studies of the Institute for International Studies, vary the designated subjects in their International

Studies major. Refer to the List of Approved Substitute Subjects in this handbook.

Course structure

Year 1

Semester 1

023111	Practicum 1: Beginning Teaching – Issues in the Primary School	8cp
021322	Information Technology (FY)	
024211	English Education 1 (FY)	
023512	Sociological Bases of Education	4cp
029311	Aboriginal and Torres Strait Islanders History and Cultures	4cp
029312	Australian Studies (FY)	

Semester 2

023112	Practicum 2: Developing Classroom Management	8cp
021311	Information Technology (FY)	4cp
023511	Developmental Psychology	4cp
024211	English Education 1 (FY)	6cp
025211	Mathematics Education 1	4cp
027211	PDHPE Education 1	4cp
029312	Australian Studies (FY)	4cp

Year 2

Semester 3

023113	Practicum 3: Promoting Student-Centred Learning	8cp
971xxx	Language and Culture 1	8cp
025212	Mathematics Education 2 (FY)	
028211	Science and Technology Education 1	4cp
027212	PDHPE Education 2	4cp

Semester 4

023114	Practicum 4: Managing Learning Difficulties	8cp
972xxx	Language and Culture 2	8cp
025212	Mathematics Education 2 (FY)	4cp
026211	Music Education 1	4cp

Year 3

Semester 5

023115	Practicum 5: Designing Educational Programs	6cp
024213	English Education 3: Teaching ESL	4cp
020211	Visual Art and Craft Education (FY)	
50140	Modernisation and Social Change	8cp
973xxx	Language and Culture 3	8cp

Semester 6

023116	Practicum 6: Assessing and Evaluating in Education	6cp
029211	Visual Art and Craft Education (FY)	6cp
976xxx	Contemporary Society	8cp
974xxx	Language and Culture 4	8cp

Year 4

Semester 7

977xxx	In-country Study 1	24cp
--------	--------------------	------

Semester 8

978xxx	In-country Study 2	24cp
--------	--------------------	------

Year 5

Semester 9

023117	Practicum 7: Reflecting on Educational Practice (FY)	
025213	Mathematics Education 3	4cp
026212	Music Education 2	4cp
024222	English Education 2A (FY)	
024214	English Education 4	4cp
029211	Social and Environmental Education (FY)	

Semester 10

023117	Practicum 7: Reflecting on Educational Practice (FY)	8cp
023506	Philosophical Bases of Education	4cp
028212	Science and Technology Education 2	4cp
024222	English Education 2A (FY)	6cp
029211	Social and Environmental Education (FY)	6cp

Further details of Teacher Education subjects may be found in the *Faculty of Education Handbook*. Alternatively, queries may be addressed to the combined degree course coordinator in the Faculty of Education on 9514 5245. Queries regarding the International Studies component of the course should be addressed to the Institute itself on 9514 1574.

Combined degree students are required to confirm, during the University enrolment period, the subjects they intend to take for the year with the Institute at 9-11 Broadway (next door to the Co-op Bookshop).

Bachelor of Engineering, Bachelor of Arts in International Studies, Diploma in Engineering Practice

Course code: E002

The Faculty of Engineering offers a combined degree program leading to the award of a Bachelor of Engineering (BE), Diploma in Engineering Practice (DipEngPrac) in one of the Faculty's fields of specialisation and a Bachelor of Arts (BA) degree in International Studies. The program is offered in collaboration with the Institute for International Studies.

The purpose of the program is to provide skills appropriate for a leadership role in the professional practice of engineering in an international setting. It is offered in the belief that engineering is increasingly international in character, and that Australian professionals can benefit from the early development of an international perspective and a fluency in cross-cultural interactions.

The program links traditional engineering studies with the study of a language and culture, other than English, and the practice of engineering in a foreign country or countries. It is available in association with the Bachelor of Engineering course in any of the fields already offered:

- Civil Engineering
- Civil and Environmental Engineering
- Computer Systems Engineering
- Electrical Engineering
- Telecommunications Engineering
- Mechanical Engineering

Exemptions

Under normal circumstances no exemptions will be granted for previous study of languages for students enrolled in this program. The Language and Culture subjects admit students a different levels in order to enhance each student's communicative ability.

Admission requirements

Students normally enter the program directly from high school and are admitted on the basis of academic performance, a demonstrated proficiency in one of the target languages, a commitment to a career in engineering and prospects for leadership in the profession.

The proficiency in language may have been developed at high school, through private study or through the student's family background.

Entry requirements of the relevant Bachelor of Engineering course, including its minimum TER cut-off, must be met. The minimum TER for the BE BA program has been set at 80. Selection is made through UAC (Universities Admissions Centre) and a UTS interview. In order to be selected for an UTS interview, candidates must complete a questionnaire available from the Faculty of Engineering. Quotas will be set for each engineering and culture specialisation based on the expected support of industry.

Attendance

The program is offered only on a sandwich attendance basis, although students will be able to transfer to part-time attendance for periods during the course, if their circumstances make this desirable.

The overall duration of the program is a minimum of six years. It requires satisfactory completion of eight semesters of academic work, plus at least 24 weeks of appropriate industrial experience in Australia (refer to the *Faculty of Engineering Handbook*), and a year of academic study and work experience overseas. The overseas year will normally count as one semester of academic work and 24 weeks of industrial experience. For the purpose of calculating HECS, the course is deemed to be equivalent to five years of full-time study.

Course structure

Students will be required to complete a total of 264 credit points, comprising 188 credit points of BE studies, 64 credit points of International Studies and 12 credit points in the Engineering Practical Component. Engineering and International Studies are integrated throughout the program, and the combined degree is awarded on completion. It is not possible to complete either degree separately at an intermediate point.

The program requires each student to spend a full year overseas, normally in the fourth year of enrolment. This will be preceded by preparatory courses in the language and culture of the country to be visited, undertaken during the second and third years concurrently with the engineering curriculum at UTS. The overseas year includes further intensive exposure to language and culture, the study of academic subjects at a host university, and the study of the practice of engineering in the country concerned, preferably in conjunction with a period of employment in industry.

UTS is developing a network of partner universities and industry contacts in several countries, and will extend the network as circumstances permit. Overseas travel and living costs are the responsibility of each student, but UTS aims to establish industry sponsorship schemes to cover all or part of these costs. Students who fail to satisfactorily complete either engineering or arts subjects at an overseas location will be required to complete alternative studies at UTS.

Course program

Within the integrated program, subjects principally associated with the Bachelor of Arts in International Studies component are planned as follows:

	CP	HPW
Stages 1, 2		
971xxx Language and Culture 1	8	6
972xxx Language and Culture 2	8	6
Stage 3		
973xxx Language and Culture 3	8	6
Stage 4		
974xxx Language and Culture 4	8	6
Stage 5		
xxxxx Engineering experience		
Stage 6		
— — — —		
Stage 7		
50140 Modernisation and Social Change	8	4
97xxxx Language and Culture 5	8	6

Stage 8		
97xxxx Language and Culture 6	8	6
Stage 9		
48502 Engineering Experience 2 (overseas)		2
Stage 10		
xxxxxx Overseas study elective	24	4
Stage 11		
— — — —		
Stage 12		
976xxx Contemporary Society	8	

The program will focus principally, but not exclusively, on Pacific rim countries. The languages that have been approved for students to study are Chinese, French, German, Indonesian, Japanese, Spanish and Thai. Others may be added to these in future years.

The program is expected to gain full accreditation by the Institution of Engineers, Australia.

Further details of Engineering subjects may be found in the *Faculty of Engineering Handbook*. Alternatively, queries may be addressed to the combined degree course coordinator in the Faculty of Engineering on 9514 2591. Queries regarding the International Studies component of the course should be addressed to the Institute itself on 9514 1574.

The Institute for International Studies is not responsible for the period of 'International Practice of Engineering' for Engineering students. Further details of the Engineering 'In-country Study' should be obtained from the Faculty of Engineering.

Bachelor of Applied Science in Information Studies/Bachelor of Arts in International Studies

Course code: H031

The enormous technological advances that have occurred over the past decade in the management of information have placed a great deal of pressure on information professionals and their environment. Not only is there more information to access and organise, but the wealth of information is increasingly less likely to be produced in English or from a cultural background immediately accessible to Australian information professionals. The combined degree program in Information Studies and International Studies provides students of information studies with a knowledge and understanding of another language and culture. Apart from its wider educational goals, the program should also help graduates become more effective as information professionals, whether in Australia or overseas.

The Bachelor of Applied Science in Information Studies/Bachelor of Arts in International Studies is a five-year degree program that integrates Information Studies with a major in the language and culture of another country. Students spend the fourth year of study at a university overseas. All existing arrangements for both the Bachelor of Applied Science in Information Studies and the Bachelor of Arts in International Studies apply equally to the combined degree program in Information Studies and International Studies.

To graduate, a student is required to have completed 240 credit points of study: 144 credit points in Information Studies and 96 credit points in International Studies. For details on patterns of study of the Information Studies section of this combined degree, please consult the *Faculty of Humanities and Social Sciences Handbook*.

The International Studies program requires undergraduates to study one major – a country or region of specialisation – over a minimum of three years. Students study language and culture for at least two years in Sydney, and this is followed by a period of study overseas. The following majors are offered: Argentina, Australia and the Asia-Pacific Region, Chile, China, Croatia, France, Germany, Greece, Indonesia, Italy, Japan, Latin America,

Malaysia, Mexico, Poland, Russia, Slovenia, South China, South-East Asia, Spain, Taiwan, Thailand and Ukraine.

Students are admitted to the International Studies program with no guarantee of entry to a specific major, although students' preferences are taken into consideration. The Institute reserves the right to allocate places in majors according to its resources and arrangements with overseas universities.

There are no prior language requirements for the International Studies component of this combined degree, however, some majors within the International Studies program do have specific admission requirements. Entry to the Greece, Poland, Slovenia and Ukraine majors is restricted to students who have a sound working knowledge of the language of their selected specialisation.

Each student's choice of major and subjects to study in the International Studies Program requires the approval of the Board of Studies of the Institute for International Studies.

In exceptional circumstances, students may, with the approval of the Board of Studies of the Institute for International Studies, vary the designated subjects in their International Studies major. Refer to the List of Approved Substitute Subjects in this handbook.

Each of the majors within the International Studies program has a value of 96 credit points, and includes 32 credit points (four subjects) of instruction in an appropriate Language and Culture; 8 credit points (one subject) on Modernisation and Social Change; 8 credit points (one subject) on Contemporary Society; and 48 credit points (two semesters) of study at a university or institution of higher education in a country of the major.

Students do not need to have previously studied a language and culture other than English to be able to successfully complete the program. All students are required to complete four consecutive semesters of study of Language and Culture before proceeding to In-country Study. There are different classes available for students with different levels of language proficiency.

The Institute for International Studies makes the arrangements for students to spend two semesters of In-country Study at an institution of higher education in a country of their major. The costs of tuition in host institutions overseas and travel between Sydney and the designated host institutions are borne by UTS except in cases where a scholarship has been awarded

to the student with provision for these costs. Under those circumstances, the funds that would have otherwise been allocated towards the student's tuition and travel will be redirected to support the In-country Study program in general. In most cases the cost of living for the period of In-country Study will not exceed the cost of living away from home in Sydney. However, students should be aware that the cost of living in some countries – notably Argentina, France, Germany, Hong Kong, Japan and Taiwan – may be higher than in Sydney.

Course program

Year 1

Autumn semester

D 50105	Communication and Information Environments	6cp
D 50107	Contemporary Cultures 1	6cp
D 50109	Power and Change in Australia	6cp
P 50112	Information in Society	6cp

Spring semester

D 50106	Media, Information and Society	6cp
D 50108	Contemporary Cultures 2	6cp
D 50111	Colonialism and Modernity	6cp
P 50113	Information Resources	6cp

Year 2

Autumn semester

I 971xxx	Language and Culture 1	8cp
I 50140	Modernisation and Social Change	
D 50124	Information Needs and Uses (prerequisite 50105 and 50106)	8cp

Spring semester

I 972xxx	Language and Culture 2	8cp
D 50126	Information and the Organisation (prerequisite 50124)	8cp
E xxxxx	Elective	8cp

Year 3

Autumn semester

I 973xxx	Language and Culture 3	8cp
P xxxxx	one subject at the 200 level from the Information Professional strand	8cp
E xxxxx	Elective	8cp

Spring semester

I 974xxx	Language and Culture 4	8cp
I 976xxx	Contemporary Society	8cp
P 50144	Organising and Retrieving Information (prerequisite 50113)	8cp

Year 4

Autumn semester

I 977xxx	In-country Study 1	24cp
----------	--------------------	------

Spring semester

I 978xxx	In-country Study 2	24cp
----------	--------------------	------

Year 5

Autumn semester

D 50173	Knowledge, Organisation and Access (prerequisite 50124)	8cp
---------	--	-----

P xxxxx	one subject at the 300 level from the Information Professional strand	8cp
---------	---	-----

E xxxxx	Elective	8cp
---------	----------	-----

Spring semester

D 50172	Information, Society and Policy (prerequisite 50124)	8cp
---------	---	-----

P 50190	Professional Project	8cp
---------	----------------------	-----

E xxxxx	Elective	8cp
---------	----------	-----

D = Disciplinary Studies subject

P = Professional Studies subject

I = International Studies subject

E = Elective subject

Further details of Information Studies subjects can be found in the *Faculty of Humanities and Social Sciences Handbook*. Queries regarding the International Studies component of the course should be addressed to the Institute itself on 9514 1574.

Combined degree students are required to confirm, during the University enrolment period, the International Studies subjects they intend to take for the year with the Institute at 9-11 Broadway (next door to the Co-op Bookshop).

Bachelor of Arts in Social Science and in International Studies

Course code: H030

The combined degree program in Social Science and International Studies provides social science students with a knowledge and understanding of another language and culture. Apart from its wider educational goals, the program should also assist social science graduates in living and working outside Australia. In a globalised world, there is an increased number of work opportunities in international organisations. Aid, development, community services, education and training are examples of areas rapidly expanding in many of the countries in our region, as well as elsewhere.

The Bachelor of Arts in Social Science and in International Studies is a five-year degree program in which the study of Social Science is integrated with a major in the language and culture of another country. Students spend the fourth year of study at a university overseas. All existing arrangements for both the Bachelor of Arts in Social Science and the Bachelor of Arts in International Studies apply equally to the combined degree program in Social Science and International Studies.

To graduate, a student is required to have completed 240 credit points of study: 144 credit points in Social Science and 96 credit points in International Studies. For detailed information on patterns of study of the Social Sciences component of this combined degree, please consult the *Faculty of Humanities and Social Sciences Handbook*.

The Bachelor of Arts in International Studies requires undergraduates to study one major – a country or region of specialisation – over a minimum of three years. Students study language and culture for at least two years in Sydney, and this is followed by a period of study overseas. The following majors are offered: Argentina, Australia and the Asia-Pacific Region, Chile, China, Croatia, France, Germany, Greece, Indonesia, Italy, Japan, Latin America, Malaysia, Mexico, Poland, Russia, Slovenia, South China, South-East Asia, Spain, Taiwan, Thailand and Ukraine.

In general, there are no prior language requirements for the International Studies component of this combined degree, however, some majors within the International Studies

program do have specific admission requirements. Entry to the Greece, Poland, Slovenia and Ukraine majors is restricted to students who have a sound working knowledge of the language of their selected specialisation. Students are admitted to the International Studies program with no guarantee of entry to a specific major, although students' preferences are taken into consideration. The Institute reserves the right to allocate places in majors according to its resources and arrangements with overseas universities.

Each student's choice of major and subjects to study in the International Studies program requires the approval of the Board of Studies of the Institute for International Studies.

In exceptional circumstances, students may, with the approval of the Board of Studies of the Institute for International Studies, vary the designated subjects in their International Studies major. Refer to the List of Approved Substitute Subjects in this handbook.

Each of the majors within the International Studies program has a value of 96 credit points, and includes 32 credit points (four subjects) of instruction in an appropriate Language and Culture; 8 credit points (one subject) on Modernisation and Social Change; 8 credit points (one subject) on Contemporary Society; and 48 credit points (two semesters) of study at a university or institution of higher education in a country of the major.

Students do not need to have previously studied a language and culture other than English to be able to successfully complete the program. All students are required to complete four consecutive semesters of study of Language and Culture before proceeding to In-country Study. There are different classes available for students with different levels of language proficiency.

The Institute for International Studies makes the arrangements for students to spend two semesters of In-country Study at an institution of higher education in a country of their major. The costs of tuition in host institutions overseas and travel between Sydney and the designated host institutions are borne by UTS except in cases where a scholarship has been awarded to the student with provision for these costs. Under those circumstances, the funds that would have otherwise been allocated towards the student's tuition and travel will be redirected to support the In-country Study program in general. In most cases the cost of

living for the period of In-country Study will not exceed the cost of living away from home in Sydney. However, students should be aware that the cost of living in some countries – notably Argentina, France, Germany, Hong Kong, Japan and Taiwan – may be higher than in Sydney.

Course program

Year 1

Autumn semester

D 50105	Communication and Information Environments	6cp
D 50107	Contemporary Cultures 1	6cp
D 50109	Power and Change in Australia	6cp
P 50120	Introduction to Social Inquiry	6cp

Spring semester

D 50106	Media, Information and Society	6cp
D 50108	Contemporary Cultures 2	6cp
D 50111	Colonialism and Modernity	6cp
P 50121	Theory and Method	6cp

Year 2

Autumn semester

I 971xxx	Language and Culture 1	8cp
I 50140	Modernisation and Social Change	8cp
D 50142	Social Theory	8cp

Spring semester

I 972xxx	Language and Culture 2	8cp
D xxxxx	one subject at the 200 level from the Social, Political and Historical Studies Disciplinary strand	8cp
E xxxxx	Elective	8cp

Year 3

Autumn semester

I 973xxx	Language and Culture 3	8cp
P 50164	Research Methods 1	8cp
E xxxxx	Elective	8cp

Spring semester

I 974xxx	Language and Culture 4	8cp
I 976xxx	Contemporary Society	
P xxxxx	one subject at the 200 level from the Social Inquiry and Change Professional strand	8cp

Year 4

Autumn semester

I 977xxx	In-country Study 1	24cp
----------	--------------------	------

Spring semester

I 978xxx	In-country Study 2	24cp
----------	--------------------	------

Year 5

Autumn semester

D xxxxx	one subject at the 300 level from the Social, Political and Historical Studies Disciplinary strand	8cp
P xxxxx	one subject at the 300 level from the Social Inquiry and Change Professional strand	8cp
E xxxxx	Elective	8cp

Spring semester

D xxxxx	one subject at the 300 level from the Social, Political and Historical Studies Disciplinary strand	8cp
P xxxxx	one subject at the 300 level from the Social Inquiry and Change Professional strand	8cp
E xxxxx	Elective	8cp

D = Disciplinary Studies subject
 P = Professional Studies subject
 I = International Studies subject
 E = Elective subject

Further details of Social Science subjects can be found in the *Faculty of Humanities and Social Sciences Handbook*. Queries regarding the International Studies component of the course should be addressed to the Institute itself on 9514 1574.

Combined degree students are required to confirm, during the University enrolment period, the International Studies subjects they intend to take for the year with the Institute at 9-11 Broadway (next door to the Co-op Bookshop).

Bachelor of Arts in Communication (Journalism) and in International Studies

Course code: H026

The combined degree program in Communication (Journalism) and International Studies provides students specialising in Journalism with additional practical skills, in particular those that increase awareness of international contexts through providing the opportunity to acquire knowledge and understanding of a language and culture other than English. In the age of global communications, it is more important than ever for journalists to have an understanding of international affairs and broader cultural perspectives.

The structure of the five-year degree in Communication (Journalism) and International Studies is derived from the combination of the Bachelor of Arts in Communication (Journalism) and the Bachelor of Arts in International Studies.

All arrangements currently in force for both the Bachelor of Arts in Communication (Journalism) and the Bachelor of Arts in International Studies apply equally to the combined degree program in Communication (Journalism) and International Studies.

To graduate a student is required to have completed 240 credit points: 144 credit points in Communication (Journalism); and 96 credit points in International Studies. For detailed information on the Communication (Journalism) pattern of study, please consult the *Faculty of Humanities and Social Sciences handbook*.

The Bachelor of Arts in International Studies requires undergraduates to study a major – a region or country specialisation – over a minimum of three years. In Sydney students study language and culture for at least two years, followed by a period of study overseas. The following range of majors is available: Argentina, Australia and the Asia-Pacific Region, Chile, China, Croatia, France, Germany, Greece, Indonesia, Italy, Japan, Latin America, Malaysia, Mexico, Poland, Russia, Slovenia, South China, South-East Asia, Spain, Taiwan, Thailand and Ukraine. Entry to the Greece, Poland, Slovenia and Ukraine specialisations is restricted to students with a sound working knowledge of the language of their selected specialisation.

Each of the specialisations within the International Studies program is 96 credit points, and includes 32 credit points (four subjects) of instruction in Language and Culture; 16 credit points (two subjects) of study of contemporary society; and 48 credit points (two semesters) of study at a university or institution of higher education in the country or region of specialisation.

Those who have not previously studied a language and culture other than English are as able to complete this program as those who have. All students are required to complete four consecutive semesters of study of Language and Culture before proceeding to In-country Study. There are different classes available for students according to their level of language proficiency.

The Institute for International Studies makes arrangements for students to spend two semesters of In-country Study at an institution of higher education in a country of their major. The costs of tuition in host institutions overseas and travel between Sydney and the designated host institutions are borne by UTS except in cases where a scholarship has been awarded to the student with provision for these costs. Under those circumstances, the funds that would have otherwise been allocated towards the student's tuition and travel will be redirected to support the In-country Study program in general. In most cases the cost of living for the period of In-country Study will not exceed the cost of living away from home in Sydney. However, students should be aware that the cost of living in some countries – notably Argentina, France, Germany, Hong Kong, Japan and Taiwan – may be higher than in Sydney.

Course program

Year 1

Autumn semester

D	50105	Communication and Information Environments	6cp
D	50107	Contemporary Cultures 1	6cp
D	50109	Power and Change in Australia	6cp
P	50114	Journalism 1	6cp

Spring semester

D	50106	Media, Information and Society	6cp
D	50108	Contemporary Cultures 2	6cp
D	50111	Colonialism and Modernity	6cp
P	50115	Journalism 2	6cp

Year 2

Autumn semester

I	971xxx	Language and Culture 1	8cp
I	50140	Modernisation and Social Change	8cp
D	50128	Media, Information and the Law	8cp

Spring semester

I	972xxx	Language and Culture 2	8cp
D	50129	News and Current Affairs	8cp
P	xxxxx	one subject at the 200 level in the Journalism Professional strand	8cp

Year 3

Autumn semester

I	973xxx	Language and Culture 3	8cp
P	xxxxx	one subject at the 200 level from the Journalism Professional strand	8cp
E	xxxxx	Elective	8cp

Spring semester

I	974xxx	Language and Culture 4	8cp
I	976xxx	Contemporary Society	8cp
E	xxxxx	Elective	8cp

Year 4

Autumn semester

I	977xxx	In-country Study 1	24cp
---	--------	--------------------	------

Spring semester

I	978xxx	In-country Study 2	24cp
---	--------	--------------------	------

Year 5

Autumn semester

D	50174	Professional Practice and Culture	8cp
P	xxxxx	one subject at the 300 level from the Journalism Professional strand	8cp
E	xxxxx	Elective	8cp

Spring semester

P	xxxxx	one subject at the 300 level from the Journalism Professional strand	8cp
E	xxxxx	Elective	8cp
E	xxxxx	Elective	8cp

D = Disciplinary Studies subject
 P = Professional Studies subject
 I = International Studies subject
 E = Elective subject

Further details of the Communication (Journalism) component can be found in the *Faculty of Humanities and Social Sciences Handbook*. Queries regarding the International Studies component of the course should be addressed to the Institute itself on 9514 1574.

Combined degree students are required to confirm, during the University enrolment period, the International Studies subjects

they intend to take for the year with the Institute at 9-11 Broadway (next door to the Co-op Bookshop).

Bachelor of Arts in Communication (Media Arts and Production) and in International Studies

Course code: H027

The combined degree program in Media Arts and Production and International Studies provides students with additional practical skills, in particular those that increase awareness of their international contexts through providing the opportunity to acquire knowledge and understanding of a language and culture other than English. The emphasis in Media Arts and Production lies in recognising that the media and cultural industries are undergoing enormous changes in identities and audiences. The course offers students a deep understanding of this through teaching the integration of historical, conceptual and aesthetic techniques associated with audiovisual media. The program should also assist students to deal more effectively as media arts and production professionals in Australia and overseas.

The structure of the five-year degree in Communication (Media Arts and Production) and International Studies is derived from the combination of the Bachelor of Arts in Communication (Media Arts and Production) and the Bachelor of Arts in International Studies.

All arrangements currently in force for both the Bachelor of Arts in Communication (Media Arts and Production) and the Bachelor of Arts in International Studies apply equally to the proposed combined degree program.

To graduate a student is required to have completed 240 credit points: 144 credit points in Communication (Media Arts and Production); and 96 credit points in International Studies. For detailed information on the Communication (Media Arts and Production) pattern of study of this combined degree, please consult the *Faculty of Humanities and Social Sciences Handbook*.

The Bachelor of Arts in International Studies requires undergraduates to study a major – a region or country specialisation – over a minimum of three years. In Sydney students

study language and culture for at least two years, followed by a period of study overseas. The following range of majors is available: Argentina, Australia and the Asia-Pacific Region, Chile, China, Croatia, France, Germany, Greece, Indonesia, Italy, Japan, Latin America, Malaysia, Mexico, Poland, Russia, Slovenia, South China, South-East Asia, Spain, Taiwan, Thailand and Ukraine. Entry to the Greece, Poland, Slovenia and Ukraine specialisations is restricted to students with a sound working knowledge of the language of their selected specialisation.

Each of the specialisations within the International Studies program is 96 credit points, and includes 32 credit points (four subjects) of instruction in Language and Culture; 16 credit points (two subjects) of study of Contemporary Society; and 48 credit points (two semesters) of study at a university or institution of higher education in the country or region of specialisation.

Those who have not previously studied a language and culture other than English are as able to complete this program as those who have. All students are required to complete four consecutive semesters of study of Language and Culture before proceeding to In-country Study. There are different classes available for students according to their level of language proficiency.

The Institute for International Studies makes arrangements for students to spend two semesters of In-country Study at an institution of higher education in a country of their major. The costs of tuition in host institutions overseas and travel between Sydney and the designated host institutions are borne by UTS except in cases where a scholarship has been awarded to the student with provision for these costs. Under those circumstances, the funds that would have otherwise been allocated towards the student's tuition and travel will be redirected to support the In-country Study program in general. In most cases the cost of living for the period of In-country Study will not exceed the cost of living away from home in Sydney. However, students should be aware that the cost of living in some countries – notably Argentina, France, Germany, Hong Kong, Japan and Taiwan – may be higher than in Sydney.

Course program

Year 1

Autumn semester

D	50105	Communication and Information Environments	6cp
D	50107	Contemporary Cultures 1	6cp
D	50109	Power and Change in Australia	6cp
D	50117	Media Arts and Production 1	6cp

Spring semester

D	50106	Media, Information and Society	6cp
D	50108	Contemporary Cultures 2	6cp
D	50111	Colonialism and Modernity	6cp
D	50118	Media Arts and Production 2	6cp

Year 2

Autumn semester

I	971xxx	Language and Culture 1	8cp
I	50140	Modernisation and Social Change	8cp
D	xxxxx	one subject at the 200 level from the Cultural Studies Disciplinary strand	8cp

Spring semester

I	972xxx	Language and Culture 2	8cp
E	xxxxx	Elective	8cp
E	xxxxx	Elective	8cp

Year 3

Autumn semester

I	973xxx	Language and Culture 3	8cp
P	xxxxx	one subject at the 200 level in the Media Arts and Production Professional strand	8cp
E	xxxxx	Elective	8cp

Spring semester

I	974xxx	Language and Culture 4	8cp
I	976xxx	Contemporary Society	8cp
P	xxxxx	one subject at the 200 level in the Media Arts and Production Professional strand	8cp

Year 4

Autumn semester

I	977xxx	In-country Study	24cp
---	--------	------------------	------

Spring semester

I	978xxx	In-country Study	24cp
---	--------	------------------	------

Year 5

Autumn semester

D	xxxxx	one subject at the 300 level in the Cultural Studies Disciplinary strand	8cp
---	-------	--	-----

P	xxxxx	one subject at the 300 level in the Media Arts and Production strand	8cp
E	xxxxx	Elective	8cp

Spring semester

P	xxxxx	one subject at the 300 level in the Media Arts and Production Professional strand	8cp
E	xxxxx	Elective	8cp
E	xxxxx	Elective	8cp

- D = Disciplinary Studies subject
- P = Professional Studies subject
- I = International Studies subject
- E = Elective subject

Further details of the Communication (Media Arts and Production) component can be found in the *Faculty of Humanities and Social Sciences Handbook*. Queries regarding the International Studies component of the course should be addressed to the Institute itself on 9514 1574.

Combined degree students are required to confirm, during the University enrolment period, the International Studies subjects they intend to take for the year with the Institute at 9-11 Broadway (next door to the Co-op Bookshop).

Bachelor of Arts in Communication (Public Communication) and in International Studies

Course code: H028

The combined degree program in Public Communication and International Studies provides students with additional practical skills, in particular those that increase awareness of their international contexts through providing the opportunity to acquire knowledge and understanding of a language and culture other than English. Different cultural, political and social systems and practices are reflected in the different ways in which public communication is practised globally. International perspectives on public relations and advertising enable graduates to transcend national barriers and be competitive in a global environment.

The structure of the five-year degree in Public Communication and International Studies is derived from the combination of the Bachelor of Arts in Communication (Public Communication) and the Bachelor of Arts in International Studies.

All arrangements currently in force for both the Bachelor of Arts in Communication (Public Communication) and the Bachelor of Arts in International Studies apply equally to the proposed combined degree program.

To graduate a student is required to have completed 240 credit points: 144 credit points in Communication; and 96 credit points in International Studies. For detailed information on the Public Communication pattern of study, please consult the *Faculty of Humanities and Social Sciences handbook*.

The Bachelor of Arts in International Studies requires undergraduates to study a major – a region or country specialisation – over a minimum of three years. In Sydney students study language and culture for at least two years, followed by a period of study overseas. The following range of majors is available: Argentina, Australia and the Asia-Pacific Region, Chile, China, Croatia, France, Germany, Greece, Indonesia, Italy, Japan, Latin America, Malaysia, Mexico, Poland, Russia, Slovenia, South China, South-East Asia, Spain, Taiwan, Thailand and Ukraine. Entry to the Greece, Poland, Slovenia and Ukraine specialisations is restricted to students with a sound working knowledge of the language of their selected specialisation.

Each of the specialisations within the International Studies Program is 96 credit points, and includes 32 credit points (four subjects) of instruction in Language and Culture; 16 credit points (two subjects) of study of Contemporary Society; and 48 credit points (two semesters) of study at a university or institution of higher education in the country or region of specialisation.

Those who have not previously studied a language and culture other than English are as able to complete this program as those who have. All students are required to complete four consecutive semesters of study of Language and Culture before proceeding to In-country Study. There are different classes available for students according to their level of language proficiency.

The Institute for International Studies makes arrangements for students to spend two semesters of In-country Study at an institution of higher education in a country of their major. The costs of tuition in host institutions overseas and travel between Sydney and the designated host institutions are borne by UTS except in cases where a scholarship has been awarded to the student with provision for these costs.

102 UNDERGRADUATE COURSES

Under those circumstances, the funds that would have otherwise been allocated towards the student's tuition and travel will be redirected to support the In-country Study program in general. In most cases the cost of living for the period of In-country Study will not exceed the cost of living away from home in Sydney. However, students should be aware that the cost of living in some countries – notably Argentina, France, Germany, Hong Kong, Japan and Taiwan – may be higher than in Sydney.

Course program

Year 1

Autumn semester

D	50105	Communication and Information Environments	6cp
D	50107	Contemporary Cultures 1	6cp
D	50109	Power and Change in Australia	6cp
P	50118	Public Communication Processes	6cp

Spring semester

D	50106	Media, Information and Society	6cp
D	50108	Contemporary Cultures 2	6cp
D	50111	Colonialism and Modernity	6cp
P	50119	Public Communication Challenges	6cp

Year 2

Autumn semester

International Studies			
I	971xxx	Language and Culture 1	8cp
I	50140	Modernisation and Social Change	8cp
D	xxxxx	one subject at the 200 level from any one of the three Disciplinary strands	8cp

Spring semester

I	972xxx	Language and Culture 2	8cp
D	xxxxx	one subject at the 200 level from the same Disciplinary strand as above	8cp
E	xxxxx	Elective	8cp

Year 3

Autumn semester

I	973xxx	Language and Culture 3	8cp
P	xxxxx	one subject at the 200 level from the Public Communication Professional strand	8cp
E	xxxxx	Elective	8cp

Spring semester

I	974xxx	Language and Culture 4	8cp
I	976xxx	Contemporary Society	8cp

P	xxxxx	one subject at the 200 level from the Public Communication Professional strand	8cp
---	-------	--	-----

Year 4

Autumn semester

I	977xxx	In-country Study 1	24cp
---	--------	--------------------	------

Spring semester

I	978xxx	In-country Study 2	24cp
---	--------	--------------------	------

Year 5

Autumn semester

D	xxxxx	one subject at the 300 level from the Disciplinary strand from which 200 level subjects were completed	8cp
P	50214	Public Communication Contexts (<i>prerequisite 50160 or 50162</i>)	8cp
E	xxxxx	Elective	8cp

Spring semester

P	50215	Public Communication Professional Practice (<i>prerequisite 50214</i>)	8cp
E	xxxxx	Elective	8cp
E	xxxxx	Elective	8cp

D = Disciplinary Studies subject

P = Professional Studies subject

I = International Studies subject

E = Elective subject

Further details of the Communication (Public Communication) component can be found in the *Faculty of Humanities and Social Sciences Handbook*. Queries regarding the International Studies component of the course should be addressed to the Institute itself on 9514 1574.

Combined degree students are required to confirm, during the University enrolment period, the International Studies subjects they intend to take for the year with the Institute at 9-11 Broadway (next door to the Co-op Bookshop).

Bachelor of Arts in Communication (Writing and Contemporary Cultures) and in International Studies

Course code: H029

The combined degree program in Communication (Writing and Contemporary Cultures) and International Studies provides students with additional practical skills, in particular those that increase awareness of their international contexts through providing the opportunity to acquire knowledge and understanding of a language and culture other than English. Writing at UTS is studied as a craft, but a craft undertaken in close engagement with, and responsiveness to, the writer's society. Australia is uniquely positioned, historically and geographically, to play a significant role in the 21st century. Its writers will be a vital part of understanding and defining this role, and they will be better equipped for this task if they have a broader understanding of contemporary cultures.

The structure of the five-year degree in Communication (Writing and Contemporary Cultures) and International Studies is derived from the combination of the Bachelor of Arts in Communication (Writing and Contemporary Cultures) and the Bachelor of Arts in International Studies.

All arrangements currently in force for both the Bachelor of Arts in Communication (Writing and Contemporary Cultures) and the Bachelor of Arts in International Studies apply equally to the proposed combined degree program.

To graduate a student is required to have completed 240 credit points: 144 credit points in Communication (Writing and Contemporary Cultures); and 96 credit points in International Studies. For detailed information on the Writing and Contemporary Cultures pattern of study, please consult the *Faculty of Humanities and Social Sciences Handbook*.

The Bachelor of Arts in International Studies requires undergraduates to study a major – a region or country specialisation – over a minimum of three years. In Sydney students study language and culture for at least two years, followed by a period of study overseas. The following range of majors is available:

Argentina, Australia and the Asia-Pacific Region, Chile, China, Croatia, France, Germany, Greece, Indonesia, Italy, Japan, Latin America, Malaysia, Mexico, Poland, Russia, Slovenia, South China, South-East Asia, Spain, Taiwan, Thailand and Ukraine. Entry to the Greece, Poland, Slovenia and Ukraine specialisations is restricted to students with a sound working knowledge of the language of their selected specialisation.

Each of the specialisations within the International Studies program is 96 credit points, and includes 32 credit points (four subjects) of instruction in Language and Culture; 16 credit points (two subjects) of study of Contemporary Society; and 48 credit points (two semesters) of study at a university or institution of higher education in the country or region of specialisation.

Those who have not previously studied a language and culture other than English are as able to complete this program as those who have. All students are required to complete four consecutive semesters of study of Language and Culture before proceeding to In-country Study. There are different classes available for students according to their level of language proficiency.

The Institute for International Studies makes arrangements for students to spend two semesters of In-country Study at an institution of higher education in a country of their major. The costs of tuition in host institutions overseas and travel between Sydney and the designated host institutions are borne by UTS except in cases where a scholarship has been awarded to the student with provision for these costs. Under those circumstances, the funds that would have otherwise been allocated towards the student's tuition and travel will be redirected to support the In-country Study program in general. In most cases the cost of living for the period of In-country Study will not exceed the cost of living away from home in Sydney. However, students should be aware that the cost of living in some countries – notably Argentina, France, Germany, Hong Kong, Japan and Taiwan – may be higher than in Sydney.

Course program

Year 1

Autumn semester

D	50105	Communication and Information Environments	6cp
D	50107	Contemporary Cultures 1	6cp
D	50109	Power and Change in Australia	6cp
P	50122	Writing: Style and Structure	6cp

Spring semester

D	50106	Media, Information and Society	6cp
D	50108	Contemporary Cultures 2	6cp
D	50111	Colonialism and Modernity	6cp
P	50123	Narrative Writing	6cp

Year 2

Autumn semester

I	971xxx	Language and Culture 1	8cp
I	50140	Modernisation and Social Change	8cp
D	xxxxx	one subject at the 200 level from the Cultural Studies Disciplinary strand	8cp

Spring semester

I	972xxx	Language and Culture 2	8cp
E	xxxxx	Elective	8cp
E	xxxxx	Elective	8cp

Year 3

Autumn semester

I	973xxx	Language and Culture 3	8cp
P	xxxxx	one subject at the 200 level from the Writing Professional strand	8cp
E	xxxxx	Elective	8cp

Spring semester

I	974xxx	Language and Culture 4	8cp
I	976xxx	Contemporary Society	8cp
P	xxxxx	one subject at the 200 level from the Writing Professional strand	8cp

Year 4

Spring semester

I	977xxx	In-country Study 1	24cp
---	--------	--------------------	------

Autumn semester

I	978xxx	In-country Study 2	24cp
---	--------	--------------------	------

Year 5

Autumn semester

D	xxxxx	one subject at the 300 level from the Cultural Studies Disciplinary strand	8cp
P	xxxxx	one subject at the 300 level from the Writing Professional strand	8cp
E	xxxxx	Elective	8cp

Spring semester

P	xxxxx	one subject at the 300 level from the Writing Professional strand	8cp
E	xxxxx	Elective	8cp
E	xxxxx	Elective	8cp

D = Disciplinary Studies subject

P = Professional Studies subject

I = International Studies subject

E = Elective subject

Further details of the Communication (Writing and Contemporary Cultures) component can be found in the *Faculty of Humanities and Social Sciences Handbook*. Queries regarding the International Studies component of the course should be addressed to the Institute itself on 9514 1574.

Combined degree students are required to confirm, during the University enrolment period, the International Studies subjects they intend to take for the year with the Institute at 9-11 Broadway (next door to the Co-op Bookshop).

Bachelor of Laws/ Bachelor of Arts in International Studies

Course code: LL07

The Bachelor of Laws/Bachelor of Arts in International Studies program is offered jointly by the Faculty of Law and the Institute for International Studies. The degree provides full-time study for students wishing to obtain a professional qualification that satisfies the basic academic requirements of the Supreme Court of New South Wales for admission as a legal practitioner. A single testamur of LLB Bachelor of Arts (International Studies) is awarded. The LLB component may be awarded with First or Second Class Honours. The program is designed for students who wish to obtain an international perspective and expertise to enable them to work overseas, provide specialised legal services to Australian ethnic communities, and satisfy the demand in firms for legal practitioners who can act for foreign investors.

In addition to pursuing the full program of the Bachelor of Laws, students are required to follow a major – a country or region of specialisation – in the International Studies program. Students study language and culture for at least two years in Sydney, and this is

followed by a period of study overseas. The following majors are offered: Argentina, Chile, China, Croatia, France, Germany, Greece, Indonesia, Italy, Japan, Latin America, Malaysia, Mexico, Poland, Russia, Slovenia, South China, South-East Asia, Spain, Taiwan, Thailand and Ukraine.

Australia and the Asia-Pacific Region is available as a major to International students.

Students are admitted to the International Studies program with no guarantee of entry to a specific major, although every effort is made in trying to meet students' preferences. The Institute reserves the right to allocate places in majors according to its resources and arrangements with overseas universities.

In general, there are no prior language requirements for the International Studies component of this combined degree, however, some majors within the International Studies program do have specific admission requirements. Entry to the Greece, Poland, Slovenia and Ukraine majors is restricted to students who have a sound working knowledge of the language of their selected specialisation.

Each student's choice of major and subjects to study in the International Studies program requires the approval of the Board of Studies of the Institute for International Studies.

In exceptional circumstances, students may, with the approval of the Board of Studies of the Institute for International Studies, vary the designated subjects in their International Studies major. Refer to the List of Approved Substitute Subjects in this handbook.

All students are required to complete four consecutive semesters of study of Language and Culture before proceeding to In-country Study. There are different classes available for students with different levels of language proficiency.

The Institute for International Studies makes the arrangements for students to spend two semesters of In-country Study at an institution of higher education in a country of their major. The costs of tuition in host institutions overseas and travel between Sydney and the designated host institutions are borne by UTS except in cases where a scholarship has been awarded to the student with provision for these costs. Under those circumstances, the funds that would have otherwise been allocated towards the student's tuition and travel will be redirected to support the In-country Study program in general. In most cases the cost of

living for the period of In-country Study will not exceed the cost of living away from home in Sydney. However, students should be aware that the cost of living in some countries – notably Argentina, France, Germany, Hong Kong, Japan and Taiwan – may be higher than in Sydney.

Course structure and attendance pattern

All law subjects are taught over one semester. Students attend 12–15 hours of lectures and seminars per week. Students may be required to attend evening classes. The degree normally requires five years of full-time study for completion. For the International Studies component, students are required to complete a sequence of four subjects in Language and Culture; a subject in Contemporary Society; two semesters of study at an overseas university or institution of higher education; and a subject titled International Legal Studies.

Course program

Stage 1

70113	Legal Process and History	10cp
70105	Legal Research	4cp
76600	International Legal Studies	8cp

Stage 2

70217	Criminal Law	6cp
70211	Law of Contract	8cp
976xxx	Contemporary Society	8cp

Stage 3

70311	Law of Tort	8cp
70616	Federal Constitutional Law	8cp
971xxx	Language and Culture 1	8cp

Stage 4

70317	Real Property	8cp
70318	Personal Property	4cp
76xxx	Elective subject 1	6cp
972xxx	Language and Culture 2	8cp

Stage 5

70417	Corporate Law	8cp
70617	Administrative Law	8cp
973xxx	Language and Culture 3	8cp

Stage 6

70516	Equity and Trusts	8cp
76xxx	Elective subject 2	6cp
974xxx	Language and Culture 4	8cp

Stage 7

977xxx	In-country Study 1	24cp
--------	--------------------	------

Stage 8

978xxx In-country Study 2	24cp
---------------------------	------

Stage 9

71005 Practice and Procedure	4cp
71116 Remedies	6cp
71216 Law of Evidence	6cp
76xxx Elective subject 3	6cp
76xxx Elective subject 4	6cp

Stage 10

Legal practice major (PLT)	24cp
<i>or</i>	
Four Law electives	24cp

The Faculty of Law reserves the right to alter this information at any time without notice.

Further details of Law subjects may be found in the *Faculty of Law Handbook*. Alternatively, queries may be addressed to the combined degree course coordinator in the Faculty of Law on 9514 3769.

Queries regarding the International Studies component of the course should be addressed to the Institute itself on 9514 1574.

Combined degree students are required to confirm, during the University enrolment period, the subjects they intend to take for the year with the Institute at 9-11 Broadway (next door to the Co-op Bookshop).

Bachelor of Science in Computing Science/ Bachelor of Arts in International Studies

Course code: MC05

The combined degree program in Computing Science and International Studies provides students specialising in computing science with additional practical skills, in particular those that increase awareness of their international contexts through providing the opportunity to acquire knowledge and understanding of a language and culture other than English.

Few technologies embody the principles of globalisation as comprehensively as computing science. Even before the advent of the information highway and developments in multimedia, computers and computing had become symbols of internationalised knowledge, education and training.

The Bachelor of Science in Computing Science and Bachelor of Arts in International Studies

is a six-year degree program combining the Bachelor of Science in Computing Science with the University's Bachelor of Arts in International Studies.

To graduate a student is required to have completed 240 credit points: 144 credit points in Computing Science; and 96 credit points in International Studies.

The Computing Science component of the course aims to provide a sound education in all aspects of computing for students who intend to make a career in the profession. It is intended that the course will provide a suitable background covering all aspects of computing science short of the actual design and construction of the 'hardware' systems.

All students in the BSc in Computing Science are required to pass two Industrial Training subjects. There are a substantial number of prerequisites for Industrial Training, which in this combined degree program is normally undertaken in Years 5 and 6. To gain credit for Industrial Training students are required to obtain an approved, full-time job within the information technology industry.

The Bachelor of Arts in International Studies requires undergraduates to study a major – a region or country specialisation – over a minimum of three years. In Sydney students study language and culture for at least two years, followed by a period of study overseas. The following range of majors is available: Argentina, Chile, China, Croatia, France, Germany, Greece, Indonesia, Italy, Japan, Latin America, Malaysia, Mexico, Poland, Russia, Slovenia, South China, South-East Asia, Spain, Taiwan, Thailand and Ukraine. The Greece, Poland, Slovenia and Ukraine specialisations are only available to students with a sound working knowledge of the language of their selected specialisation.

Australia and the Asia-Pacific Region is available as a major to international students.

Each of the specialisations within the International Studies program is 96 credit points, and includes 32 credit points (four subjects) of instruction in Language and Culture; 16 credit points (two subjects) of study of Contemporary Society; and 48 credit points (two semesters) of study at a university or institution of higher education in the country or region of specialisation.

Those who have not previously studied a language and culture other than English are as able to complete this program as those who have. All students are required to complete

four consecutive semesters of study of Language and Culture before proceeding to In-country Study. There are different classes available for students according to their level of language proficiency.

The Institute for International Studies makes arrangements for students to spend two semesters of In-country Study at an institution of higher education in a country of their major. The costs of tuition in host institutions overseas and travel between Sydney and the designated host institutions are borne by UTS except in cases where a scholarship has been awarded to the student with provision for these costs. Under those circumstances, the funds that would have otherwise been allocated towards the student's tuition and travel will be redirected to support the In-country Study program in general. In most cases the cost of living for the period of In-country Study will not exceed the cost of living away from home in Sydney. However, students should be aware that the cost of living in some countries – notably Argentina, France, Germany, Hong Kong, Japan and Taiwan – may be higher than in Sydney.

Course structure

Year 1

Autumn semester

31414	Information Systems	6cp
31415	Principles of Software Development A	6cp
31416	Computing Systems Architecture	6cp
31417	Computing Practice	6cp

Spring semester

31424	Systems Modelling	6cp
31425	Principles of Software Development B	6cp
31428	Quantitative Modelling	6cp
31429	Procedural Programming	6cp

Year 2

Autumn semester

31434	Database Design	6cp
971xxx	Language and Culture 1	8cp
50140	Modernisation and Social Change	8cp
xxxxx	Computing Science elective	4cp

Spring semester

31436	Systems Software and Networks	8cp
972xxx	Language and Culture 2	8cp
xxxxx	Computing Science elective	4cp

Year 3

Autumn semester

31444	Systems Design and Development	10cp
973xxx	Language and Culture 3	8cp
xxxxx	Computing Science elective	4cp

Spring semester

22615	Accounting Information Systems	4cp
974xxx	Language and Culture 4	8cp
976xxx	Contemporary Society	8cp
xxxxx	Computing Science elective	4cp

Year 4

Autumn semester

977xxx	In-country Study 1	24cp
--------	--------------------	------

Spring semester

978xxx	In-country Study 2	24cp
--------	--------------------	------

Year 5

Autumn semester

31455	Software Development Case Study	5cp
xxxxx	Computing Science electives	8cp
31698	Industrial Training	

Spring semester

31455	Software Development Case Study	5cp
xxxxx	Computing Science elective	4cp
31698	Industrial Training	

Year 6

Autumn semester

31454	Project Management and the Professional	8cp
xxxxx	Computing Science elective	4cp
31699	Industrial Training	

Spring semester

31464	Information Technology Planning and Design	6cp
xxxxx	Computing Science electives	8cp
31699	Industrial Training	

Further details of Information Studies subjects may be found in the *Faculty of Mathematical and Computing Sciences Handbook*. Queries regarding the International Studies component of the course should be addressed to the Institute itself on 9514 1574.

Combined degree students are required to confirm, during the University enrolment period, the subjects they intend to take for the year with the Institute at 9-11 Broadway (next door to the Co-op Bookshop).

Bachelor of Science in Mathematics/Bachelor of Arts in International Studies

Course code: MM05

The combined degree program in Mathematics and International Studies provides students specialising in mathematics with additional practical skills, in particular those that increase awareness of their international contexts through providing the opportunity to acquire knowledge and understanding of a language and culture other than English.

Mathematics is inherently an internationalised activity. To quote the contemporary Chinese academic, Fang Lizhi 'There is no such thing as a German, Jewish or Chinese mathematician; there are just mathematicians.' Mathematics as a study has developed from international links – personal and professional – and clearly transcends national boundaries in its operation and contribution to knowledge.

The Bachelor of Science in Mathematics degree aims to prepare students for professional practice in industry, commerce and government and to provide the foundation for graduate studies and research. It provides great flexibility by allowing students to follow a course of study which best suits their interests and aspirations. It aims to assist the students to acquire sufficient experience and understanding in a broad range of mathematical disciplines, to enable them to apply mathematical and computing techniques to industrial and commercial problems.

The Bachelor of Science in Mathematics and Bachelor of Arts in International Studies is a five-year degree program combining the Bachelor of Science in Mathematics with the University's Bachelor of Arts in International Studies. All arrangements in force for both the Bachelor of Mathematics and the International Studies program apply equally to the combined degree program in Mathematics and International Studies.

The structure of the five-year degree in Mathematics and International Studies is derived from the combination of the Bachelor of Science in Mathematics with the Bachelor of Arts in International Studies.

To graduate a student is required to have completed 240 credit points: 144 credit points

in Mathematics; and 96 credit points in International Studies.

The Mathematics component of the combined degree is structured in three distinct sections: students follow core studies, a major in an area of the mathematical sciences, and an elective component. The core provides a thorough grounding in the elements of mathematics, statistics, operations research, computing, and their applications. Core studies, which occupy half of the Mathematics component of the joint degree, are taught predominantly in the earlier parts of the program.

Students follow a Mathematics major in one of the areas of pure or applied mathematics, statistics, or operations research. This framework provides for specialised study of a particular area of application. The major is taken in the final (fifth) year of studies.

Electives occupy 48 credit points of the Mathematics component of the program and are chosen by students to develop or strengthen their understanding in one or more areas of their choice. Electives may be chosen from any part of the University, subject to certain restrictions. Common choices are the computing major offered by the School of Mathematical Sciences, an additional major in mathematics, or a sub-major in computing, finance or one of the sciences. Students must complete at least 24 credit points of their electives in a structured sequence (typically in the form of a sub-major), thereby providing for the coherent development of a particular discipline in addition to their studies in mathematics. There are no restrictions on the remainder of the elective sequence so that students may develop particular aspects of their knowledge in ways that they see fit.

An Honours degree in mathematics (with strands in statistics, operations research and mathematics), requiring an additional year of full-time study beyond the scope of the combined degree, is also available.

The Bachelor of Arts in International Studies requires undergraduates to study a major – a region or country specialisation – over a minimum of three years. In Sydney students study language and culture for at least two years, followed by a period of study overseas. The following range of majors is available: Argentina, Chile, China, Croatia, France, Germany, Greece, Indonesia, Italy, Japan, Latin America, Malaysia, Mexico, Poland, Russia, Slovenia, South China, South-East Asia, Spain, Taiwan, Thailand and Ukraine. The Greece,

Poland, Slovenia and Ukraine specialisations are only available to students with a sound working knowledge of the language of their selected specialisation.

Australia and the Asia–Pacific Region is available as a major to international students.

Each of the specialisations within the International Studies program is 96 credit points, and includes 32 credit points (four subjects) of instruction in Language and Culture; 16 credit points (two subjects) of study of Contemporary Society; and 48 credit points (two semesters) of study at a university or institution of higher education in the country or region of specialisation.

Those who have not previously studied a language and culture other than English are as able to complete this program, as those who have. All students are required to complete four consecutive semesters of study of Language and Culture before proceeding to In-country Study. There are different classes available for students according to their level of language proficiency.

The Institute for International Studies makes arrangements for students to spend two semesters of In-country Study at an institution of higher education in a country of their major. The costs of tuition in host institutions overseas and travel between Sydney and the designated host institutions are borne by UTS except in cases where a scholarship has been awarded to the student with provision for these costs. Under those circumstances, the funds that would have otherwise been allocated towards the student’s tuition and travel will be redirected to support the In-country Study program in general. In most cases the cost of living for the period of In-country Study will not exceed the cost of living away from home in Sydney. However, students should be aware that the cost of living in some countries – notably Argentina, France, Germany, Hong Kong, Japan and Taiwan – may be higher than in Sydney.

Course structure

Year 1

Autumn semester

35100	Mathematical Practice	3cp
35101	Mathematics 1	6cp
35111	Discrete Mathematics	3cp
35170	Introduction to Computing	6cp
xxxxx	Elective ¹	6cp

Spring semester

35102	Mathematics 2	6cp
35151	Statistics 1	6cp
xxxxx	Elective ¹	6cp
xxxxx	Elective ¹	6cp

Year 2

Autumn semester

35212	Linear Algebra	6cp
35232	Advanced Calculus	6cp
971xxx	Language and Culture 1	8cp

Spring semester

35241	Optimisation 1	6cp
35252	Statistics 2	6cp
35281	Numerical Analysis 1	6cp
972xxx	Language and Culture 2	8cp

Year 3

Autumn semester

35231	Differential Equations	6cp
xxxxx	Elective ¹	6cp
50140	Modernisation and Social Change	8cp
973xxx	Language and Culture 3	8cp

Spring semester

35321	Analysis 1	6cp
974xxx	Language and Culture 4	8cp
976xxx	Contemporary Society	8cp

Year 4

Autumn semester

977xxx	In-country Study 1	24cp
--------	--------------------	------

Spring semester

978xxx	In-country Study 2	24cp
--------	--------------------	------

Year 5

Autumn semester

353xx	Mathematics Major 1	6cp
353xx	Mathematics Major 2	6cp
xxxxx	Elective ¹	6cp
xxxxx	Elective ^{1, 2}	6cp

Spring semester

353xx	Mathematics Major 3	6cp
353xx	Mathematics Major 4	6cp
xxxxx	Elective ¹	6cp
xxxxx	Elective ¹	6cp

¹ These electives are subject to those rules governing electives in the Bachelor of Science in Mathematics program.

² Students intending to complete the elective major in Computing will need to interchange Analysis 1 with an elective from Year 5, Autumn semester.

Majors

Mathematics major

Two sequences, one in pure mathematics and one in applied mathematics, are offered, although it is not expected that all subjects in both strands would be taught in any one year.

Pure Mathematics sequence

Year 5 Autumn semester

35313	Pure Mathematics 3A	6cp
35335	Mathematical Methods	6cp
		Total 12cp

Year 5 Spring semester

35314	Pure Mathematics 3B	6cp
35322	Analysis 2	6cp
		Total 12cp

Applied Mathematics sequence

Year 5 Autumn semester

35333	Applied Mathematics 3A	6cp
35335	Mathematical Methods	6cp
		Total 12cp

Year 5 Spring semester

35334	Applied Mathematics 3B	6cp
35382	Numerical Analysis 2	6cp
		Total 12cp

Statistics major

Year 5 Autumn semester

35356	Design and Analysis of Experiments	6cp
35361	Probability and Stochastic Processes	6cp
		Total 12cp

Year 5 Spring semester

35353	Regression Analysis	6cp
35355	Quality Control	6cp
		Total 12cp

Operations Research major

Year 5 Autumn semester

35342	Optimisation 2	6cp
35361	Probability and Stochastic Processes	6cp
		Total 12cp

Year 5 Spring semester

35340	Operations Research Practice	6cp
35363	Simulation Modelling	6cp
		Total 12cp

Further details of Mathematics subjects may be found in the *Faculty of Mathematical and Computing Sciences Handbook*. Queries regarding the International Studies component

of the course should be addressed to the Institute itself on 9514 1574.

Combined degree students are required to confirm, during the University enrolment period, the subjects they intend to take for the year with the Institute at 9-11 Broadway (next door to the Co-op Bookshop).

Bachelor of Mathematics and Finance/Bachelor of Arts in International Studies

Course code: MM06

The combined degree program in Mathematics and Finance and International Studies provides students specialising in mathematics and finance with additional practical skills, in particular those that increase awareness of their international contexts through providing the opportunity to acquire knowledge and understanding of a language and culture other than English.

Australia's international economic integration has coincided with other environmental and technological changes to ensure that financial institutions in this country increasingly utilise the many and varied quantitative techniques that have been developed since the early 1970s. One result is an increasing demand for a new type of graduate – one trained in both mathematics and finance, and able to operate in the international and internationalised marketplace: precisely the product of this degree program.

The Bachelor of Mathematics and Finance and Bachelor of Arts in International Studies is a five-year degree program combining the Bachelor of Mathematics and Finance with the University's Bachelor of Arts in International Studies. All arrangements in force for both the Bachelor of Mathematics and Finance and the International Studies program apply equally to the combined degree program.

To graduate a student is required to have completed 240 credit points: 144 credit points in Mathematics and Finance, and 96 credit points in International Studies.

The Mathematics and Finance components of the course include an integrated sequence of subjects in mathematics, statistics, finance, economics, accounting, business law and computing, derived from the undergraduate programs in mathematics and business.

The Bachelor of Arts in International Studies requires undergraduates to study a major – a region or country specialisation – over a minimum of three years. In Sydney students study language and culture for at least two years, followed by a period of study overseas. The following range of majors is available: Argentina, Chile, China, Croatia, France, Germany, Greece, Indonesia, Italy, Japan, Latin America, Malaysia, Mexico, Poland, Russia, Slovenia, South China, South-East Asia, Spain, Taiwan, Thailand and Ukraine. The Greece, Poland, Slovenia and Ukraine specialisations are only available to students with a sound working knowledge of the language of their selected specialisation.

Australia and the Asia–Pacific Region is available as a major to international students.

Each of the specialisations within the International Studies program is 96 credit points, and includes 32 credit points (four subjects) of instruction in Language and Culture; 16 credit points (two subjects) of study of Contemporary Society; and 48 credit points (two semesters) of study at a university or institution of higher education in the culture of specialisation.

Those who have not previously studied a language and culture other than English are as able to complete this program as those who have. All students are required to complete four consecutive semesters of study of Language and Culture before proceeding to In-country Study. There are different classes available for students according to their level of language proficiency.

The Institute for International Studies makes arrangements for students to spend two semesters of In-country Study at an institution of higher education in a country of their major. The costs of tuition in host institutions overseas and travel between Sydney and the designated host institutions are borne by UTS except in cases where a scholarship has been awarded to the student with provision for these costs. Under those circumstances, the funds that would have otherwise been allocated towards the student's tuition and travel will be redirected to support the In-country Study program in general. In most cases the cost of living for the period of In-country Study will not exceed the cost of living away from home in Sydney. However, students should be aware that the cost of living in some countries – notably Argentina, France, Germany, Hong Kong, Japan and Taiwan – may be higher than in Sydney.

Course structure

Year 1

Autumn semester

22105	Accounting A	4cp
25110	Microeconomics	4cp
25308	Financial Markets	4cp
35101	Mathematics 1	6cp
35170	Introduction to Computing	6cp

Spring semester

25209	Macroeconomics	4cp
25314	Business Finance	4cp
35100	Mathematical Practice	3cp
35102	Mathematics 2	6cp
35151	Statistics 1	6cp

Year 2

Autumn semester

35111	Discrete Mathematics	3cp
35212	Linear Algebra	6cp
35231	Differential Equations	6cp
971xxx	Language and Culture 1	8cp

Spring semester

25905	Capital Budgeting and Valuation (Hons)	6cp
35252	Statistics 2	6cp
35281	Numerical Analysis	6cp
972xxx	Language and Culture 2	8cp

Year 3

Autumn semester

35232	Advanced Calculus	6cp
79202	Business Law	4cp
50140	Modernisation and Social Change	8cp
973xxx	Language and Culture 3	8cp

Spring semester

25906	Investment Analysis (Hons)	6cp
974xxx	Language and Culture 4	8cp
976xxx	Contemporary Society	8cp

Year 4

Autumn semester

977xx	In-country Study 1	24cp
-------	--------------------	------

Spring semester

978xx	In-country Study 2	24cp
-------	--------------------	------

Year 5

Autumn semester

25620	Derivative Securities or Microeconomic Theory and Policy ¹	6cp
25621	Financing Decisions and Capital Market Theory	6cp

35321	Analysis 1	6cp
35361	Probability and Stochastic Processes	6cp

Spring semester

25421	International Financial Management	6cp
25606	Financial Time Series Analysis	6cp
35241	Optimisation 1	
	<i>or</i>	
35322	Analysis 2 ²	6cp
35353	Regression Analysis	6cp

- Students not intending to proceed to the Honours year should take the subject 25620 Derivative Securities in their final year. Those intending to take Honours in Mathematics and Finance subsequently should include instead 25210 Microeconomic Theory and Policy in the final year of their program, thereby gaining additional background in economics for subsequent honours subjects. Students taking Honours will take a more advanced subject in derivative securities in their Honours year.
- Students not intending to proceed to the Honours year should take the subject 35241 Optimisation 1 in their final year to provide them with important vocational skills in the workplace. Those proposing to take Honours should instead substitute the subject 35322 Analysis 2 in order to gain the additional background in analysis necessary for the Honours year coursework (particularly the content of the subject in advanced stochastic processes). Students taking Honours will be provided with coverage of topics in mathematical programming in the fifth year optimal control subject sequence.

Further details of Mathematics and Finance subjects may be found in the *Faculty of Mathematical and Computing Sciences Handbook*. Queries regarding the International Studies component of the course should be addressed to the Institute itself on 9514 1574.

Combined degree students are required to confirm, during the University enrolment period, the subjects they intend to take for the year with the Institute at 9-11 Broadway (next door to the Co-op Bookshop).

Bachelor of Nursing/ Bachelor of Arts in International Studies

Course code: KN10

The combined degree program in Nursing and International Studies provides nursing students with a knowledge and understanding of another language and culture. Apart from its wider educational goals, there are two practical consequences of the program. The first is that it provides graduate nurses with specific skills in their chosen language and culture. The second, and possibly more important consequence is that it makes nurses more aware of the need for intercultural sensitivities, not only through studying another language and culture, but also by living in another society for a period of time. As Australia's awareness of multiculturalism increases, this is an important consideration in the health and welfare sectors.

The Bachelor of Nursing/Bachelor of Arts in International Studies is a five-year degree program in which the study of Nursing is integrated with a major in the language and culture of another country. Students spend the fourth year of study at a university overseas. All existing arrangements for both the Bachelor of Nursing and the Bachelor of Arts in International Studies apply equally to the combined degree program in Nursing and International Studies.

To graduate, a student is required to have completed 240 credit points of study: 144 credit points in Nursing and 96 credit points in International Studies.

The Nursing component of the combined degree program is structured around three strands: Nursing Inquiry, Nursing Relationships and Clinical Nursing.

Subjects in the Nursing Inquiry strand introduce students to ethical and humanistic theory, reasoning processes, and reflections on practice and research. Subjects focus on the complexity of nursing practice and its professional requirements, including responsibility, accountability, professional development, and processes in nursing research.

The Nursing Relationships strand incorporates the study of interpersonal processes, psychological theory, sociopolitical factors influencing health care and, finally, processes for enhancing professional practice as a member of a health care team.

The Clinical Nursing strand includes both theoretical input and practical experience that enables students to apply theoretical perspectives from the various subjects to the practice of nursing care in a variety of contexts. Students are encouraged to reflect on nursing practice throughout the entire course.

Nursing practice a compulsory component of the course (a total of 793 hours) will take place in each semester of Years 1 and 5, in the first semester of Year 2 and in the second semester of Year 3. In addition, clinical skills development will be facilitated in simulated nursing practice. This clinical preparation will supplement clinical fieldwork and will be an essential component of the contact hours for each clinical nursing subject.

Graduates will meet the academic and practical requirements for registration with the NSW Nurses Registration Board.

The Bachelor of Arts in International Studies requires undergraduates to study one major – a country or region of specialisation – over a minimum of three years. Students study language and culture for at least two years in Sydney, and this is followed by a period of study overseas. The following majors are offered: Argentina, Chile, China, Croatia, France, Germany, Greece, Indonesia, Italy, Japan, Latin America, Malaysia, Mexico, Poland, Russia, Slovenia, South China, South-East Asia, Spain, Taiwan, Thailand and Ukraine.

Australia and the Asia-Pacific Region is available as a major to international students.

Students are admitted to the International Studies program with no guarantee of entry to a specific major, although every effort is made in trying to meet students' preferences. The Institute reserves the right to allocate places in majors according to its resources and arrangements with overseas universities. In general, there are no prior language requirements for the International Studies component of this combined degree, however, some majors within the International Studies program do have specific admission requirements. Entry to the Greece, Poland, Slovenia and Ukraine majors is restricted to students who have a sound working knowledge of the language of their selected specialisation.

Each student's choice of major and subjects to study in the International Studies program requires the approval of the Board of Studies of the Institute for International Studies.

In exceptional circumstances, students may, with the approval of the Board of Studies of the Institute for International Studies, vary the designated subjects in their International Studies major. Refer to the List of Approved Substitute Subjects in this handbook.

Each of the majors within the International Studies program has a value of 96 credit points, and includes 32 credit points (four subjects) of instruction in an appropriate Language and Culture; 8 credit points (one subject) on Modernisation and Social Change; 8 credit points (one subject) on Contemporary Society; and 48 credit points (two semesters) of study at a university or institution of higher education in a country of the major.

All students are required to complete four consecutive semesters of study of Language and Culture before proceeding to In-country Study. There are different classes available for students with different levels of language proficiency.

The Institute for International Studies makes the arrangements for students to spend two semesters of In-country Study at an institution of higher education in a country of their major. The costs of tuition in host institutions overseas and travel between Sydney and the designated host institutions are borne by UTS except in cases where a scholarship has been awarded to the student with provision for these costs. Under those circumstances, the funds that would have otherwise been allocated towards the student's tuition and travel will be redirected to support the In-country Study program in general. In most cases the cost of living for the period of In-country Study will not exceed the cost of living away from home in Sydney. However, students should be aware that the cost of living in some countries – notably Argentina, France, Germany, Hong Kong, Japan and Taiwan – may be higher than in Sydney.

Course structure

Year 1

Stage 1

92177	Contemporary Nursing	4cp
91518	Physiological Foundations of Health 1	6cp
92163	Contexts of Nursing Care 1A	8cp
92164	Nursing Interactions	3cp
92128	Nursing Practice 1	4cp

Stage 2

92178	Nursing Ethics	4cp
91519	Physiological Foundations of Health 2	6cp

92165	Contexts of Nursing Care 2A	6cp
92116	Nursing Life and Changes	3cp
92129	Nursing Practice 2	4cp

Year 2**Stage 3**

971xxx	Language and Culture 1	8cp
91520	Pathophysiology 1	6cp
92212	Contexts of Nursing Care 3	9cp
9214	Nursing Practice 3	5cp

Stage 4

921118	Nursing as a Practice Discipline	4cp
972xxx	Language and Culture 2	8cp
976xxx	Contemporary Society	8cp

Year 3**Stage 5**

92117	Nursing Research	4cp
50140	Modernisation and Social Change	8cp
973xxx	Language and Culture 3	8cp

Stage 6

974xxx	Language and Culture 4	8cp
91521	Pathophysiology 2	6cp
92213	Contexts of Nursing Care 4	9cp
92215	Nursing Practice 4	5cp

Year 4**Stage 7**

977xxx	In-country Study 1	24cp
--------	--------------------	------

Stage 8

978xxx	In-country Study 2	24cp
--------	--------------------	------

Year 5**Stage 9**

92154	Human Responses in Nursing Practice	3cp
92168	Nursing Ethics 2	3cp
92216	Contexts of Nursing Care 5	9cp
92218	Nursing Practice 5	6cp
92169	Primary Health Care	3cp

Stage 10

92138	Professional Relationships in Nursing	3cp
92170	Health Care Law	3cp
92217	Contexts of Nursing Care 6	9cp
921xx	Clinical Nursing Elective	3cp
92219	Nursing Practice 6	6cp

Further details of Nursing subjects may be found in the *Faculty of Nursing Handbook*. Alternatively, queries may be addressed to the combined degree course coordinator in the Faculty of Nursing on 9514 5072. Queries regarding the International Studies component of the course should be addressed to the Institute itself on 9514 1574.

Combined degree students are required to confirm, during the University enrolment period, the subjects they intend to take for the year with the Institute at 9-11 Broadway (next door to the Co-op Bookshop).

Bachelor of Health Science in Acupuncture/ Bachelor of Arts in International Studies

Course code: NH01

The combined degree program in Acupuncture and International Studies provides Acupuncture students with a greater exposure to, and understanding of, Chinese culture and a working knowledge of Chinese. Apart from its wider educational goals, the program should also make it more possible for Acupuncture graduates to practise outside Australia.

The Bachelor of Health Science in Acupuncture/Bachelor of Arts in International Studies is a five-and-a-half year degree program in which the study of Acupuncture is integrated with the China major of the International Studies program. Students spend the fifth year of study at a Chinese university. All existing arrangements for both the Bachelor of Health Science in Acupuncture and the Bachelor of Arts in International Studies apply equally to the combined degree program in Acupuncture and International Studies.

To graduate with a BHlthSc/BA, a student will be required to have completed 276 credit points of study: 180 credit points in Acupuncture and 96 credit points in Chinese Studies. Of the 96 credit points in Chinese Studies, there will be 32 credit points (four subjects) of study of the Chinese language; 16 credit points (two subjects) of the study of contemporary China and its global context; and 48 credit points (two semesters) of In-country Study at a university or institution of higher education in China.

Students do not need to have previously studied Chinese to be able to successfully complete the program. All students are required to complete four consecutive semesters of study of Chinese Language and Culture before proceeding to China for an academic year of study. There are various classes available for students with different levels of language proficiency: from classes for complete beginners, to classes for those who

have completed HSC-level Chinese and for those with more advanced language skills.

Australia and the Asia-Pacific Region is available as a major to international students.

Course structure

Year 1

Stage 1 – Autumn semester

99560	Introduction to Traditional Chinese Medicine	6cp
99502	Foundations of Traditional Chinese Medicine	6cp
99561	Clinical Theory and Clinic – Level 1 (A&M)	3cp
99563	Health Sciences 1	6cp
51389	Professional Writing and Communication	3cp

Stage 2 – Spring semester

99564	The Physiology of Qi	4cp
99565	Point Location 1	6cp
99568	Clinic – Level 2 (A&M)	4cp
99570	Health Sciences 2	6cp
92167	Foundations of Helping and Caring	4cp

Year 2

Stage 3 – Autumn semester

99571	Chinese Diagnostic System	5cp
99509	Special Points and Systems	5cp
99573	Clinic – Level 3 (A&M)	4cp
99539	Pathophysiology 1 (TCM)	6cp
91607	Research Methods 1	4cp

Stage 4 – Spring semester

99511	History and Philosophy of TCM	6cp
99575	Advanced Chinese Diagnosis	6cp
99541	Clinic – Level 4 (A&M) and Point Location 2	6cp
99540	Pathophysiology 2 (TCM)	6cp

Year 3 – entry point for continuing students who commenced their studies in 1996

Stage 5 – Autumn semester

971111	Chinese Language and Culture 1	8cp
99516	Advanced Needle Technique Ex-Channel Point Location – Clinic Level 5	5cp
99517	Independent Research Project Workshops	3cp
91604	Introductory Microbiology / Pharmacology	4cp
99518	Clinical Features of Disease	4cp

Stage 6 – Spring semester

972111	Chinese Language and Culture 2	8cp
99519	Advanced Acupuncture Principles	4cp
99521	Combined Acupuncture Therapy and Diagnostic Practice	5cp
99522	Clinical Theory (Outpatient Clinic) and Clinic – Level 6	4cp
	First Aid Certificate course	0cp
	Elective	3cp

Year 4

Stage 7 – Autumn semester

973111	Chinese Language and Culture 3	8cp
99525	Supervised Practice (Outpatient Clinic)	6cp
99526	Independent Research Project 1	7cp
99515	Advanced Chinese Massage	3cp

Stage 8 – Spring semester

974111	Chinese Language and Culture 4	8cp
976111	Contemporary China	8cp
99520	Disease States 1 and 2	8cp

Year 5

Stage 9 – Autumn semester

977110	In-country Study 1: China	24cp
--------	---------------------------	------

Stage 10 – Spring semester

978110	In-country Study 2: China	24cp
--------	---------------------------	------

Year 6

Stage 11 – Autumn semester

50140	Modernisation and Social Change	8cp
99514	Microsystems and Special Methods of Treatment	5cp
99523	Disease States 3	4cp
21816	Practice Management	3cp
99524	Specialist Lecture Topics	4cp

Stage 12 – Spring semester

99525	Supervised Practice	6cp
99534	Independent Research Project 2	6cp

Further details of Acupuncture subjects may be found in the *Faculty of Science Handbook*. Alternatively, queries may be addressed to the Faculty of Science on 9514 2500. Queries regarding the International Studies component of the course should be addressed to the Institute itself on 9514 1574.

Combined degree students are required to confirm, during the University enrolment period, the subjects they intend to take for the year with the Institute at 9-11 Broadway (next door to the Co-op Bookshop).

Bachelor of Science/ Bachelor of Arts in International Studies

Course code: N004

The combined degree program in Science and International Studies provides students specialising in Science with additional practical skills, in particular those that increase awareness of their international contexts through providing the opportunity to acquire knowledge and understanding of a language and culture other than English.

The length of the Bachelor of Science/Bachelor of Arts in International Studies is 5 years full time. However, for the Honours course in Forensic Science and International Studies the duration will be 6 years full time.

To graduate, a student in any of the pass combined degrees is required to have completed 240 credit points: 144 credit points of the appropriate science; and 96 credit points in International Studies. Students in the Bachelor of Science (Honours) in Applied Chemistry – Forensic Science and Bachelor of Arts in International Studies are required to complete 288 credit points: 192 credit points of Applied Chemistry and Forensic Science; and 96 credit points in International Studies.

The Bachelor of Arts in International Studies requires undergraduates to study a major – a region or country specialisation – over a minimum of three years. Students study language and culture in Sydney for at least two years, followed by a period of study overseas. The following range of majors is available: Argentina, Chile, China, Croatia, France, Germany, Greece, Indonesia, Italy, Japan, Latin America, Malaysia, Mexico, Poland, Russia, Slovenia, South China, South-East Asia, Spain, Taiwan, Thailand and Ukraine. In general, the International Studies program has no prior language requirement, except for entry to the Greece, Poland, Slovenia and Ukraine majors which is restricted to students who have a sound working knowledge of the language of their selected specialisation.

Australia and the Asia-Pacific Region is available as a major to international students.

Each of the specialisations within the International Studies program is 96 credit points, and includes 32 credit points (four subjects) of instruction in Language and Culture; 16 credit points (two subjects) of study of Contemporary Society; and 48 credit points

(two semesters) of study at a university or institution of higher education in the country or region of specialisation.

All students are required to complete four consecutive semesters of study of Language and Culture before proceeding to In-country Study. There are a range of language classes available for students depending on their level of language proficiency.

The Institute for International Studies makes arrangements for students to spend two semesters of In-country Study at an institution of higher education abroad. The costs of tuition in host institutions overseas and travel between Sydney and the designated host institutions are borne by UTS except in cases where a scholarship has been awarded to the student with provision for these costs. Under those circumstances, the funds that would have otherwise been allocated towards the student's tuition and travel will be redirected to support the In-country Study program in general. In most cases the cost of living for the period of In-country Study will not exceed the cost of living away from home in Sydney. However, those studying in countries or regions where the cost of living is higher than in Sydney – notably, Japan, Argentina, Taiwan, Hong Kong, France, Germany – should be prepared for the higher cost of living.

The following general pattern will be followed for each pass combined degree in Science and International Studies. This general pattern might not prove directly applicable to the Bachelor of Science (Honours) in Applied Chemistry – Forensic Science and the Bachelor of Arts in International Studies as the Forensic Science course presently runs over 4 years and this would extend the length of the double degree course to 6 years.

Course structure

Year 1

Autumn semester

Stage 1 F/T Science program	24cp
-----------------------------	------

Spring semester

Stage 2 F/T Science program	24cp
-----------------------------	------

Year 2

Autumn semester

Stage 3/4 P/T Science program	9-12cp
50140 Modernisation and Social Change	8cp
971xxx Language and Culture 1	8cp

Spring semester

Stage 3/4 P/T Science program	12-15cp
972xxx Language and Culture 2	8cp

Year 3

Autumn semester

Stage 3/4 P/T Science program	12-15cp
973xxx Language and Culture 3	8cp

Spring semester

Stage 3/4 P/T Science program	9-12cp
974xxx Language and Culture 4	8cp
976xxx Contemporary Society	8cp

Year 4

Autumn semester

977xxx In-country Study 1	24cp
---------------------------	------

Spring semester

978xxx In-country Study 2	24cp
---------------------------	------

Year 5

Autumn semester

Stage 5 F/T Science program	24cp
-----------------------------	------

Spring semester

Stage 6 F/T Science program	24cp
-----------------------------	------

Details of the Science degrees may be found in the *Faculty of Science Handbook*. Alternatively, queries may be addressed to the Faculty of Science on 9514 1753. Queries regarding the International Studies component of the course should be addressed to the Institute itself on 9514 1574.

Combined degree students are required to confirm, during the University enrolment period, the subjects they intend to take for the year with the Institute for International Studies at 9-11 Broadway (next door to the Co-op Bookshop).

International studies for international students (ISIS program)

International students can undertake a Bachelor of Arts in International Studies with a major on Australia and the Asia-Pacific Region in combination with a range of UTS professional degrees. Students study English language and Australian studies in their first year and in subsequent years they follow their professional studies combined with an International Studies specialisation on Australia and the Asia-Pacific Region. The Bachelor of Arts in International

Studies adds two years to the length of existing professional degrees.

For most combined degrees within the ISIS program students are admitted to the first year of the combined degree with an English language level of IELTS score 5.5, with 5.0 in writing or equivalent, with progress to the professional component of the combined degree requiring a level of English language competence of IELTS 6.5, with 6.0 in writing, or equivalent. Students wishing to gain entry to the combined degrees with Communication and Education require IELTS scores of 6.0 (with 6.0 in writing) and 7.0 (with 6.0 in writing) respectively.

The first year of the combined degree is spent on an intensive study of English language and Australian culture. Particular emphasis in this year is given to students acquiring the language and other skills necessary for success in studies at an Australian university. In the second year students are introduced to their professional degree. The third and fourth years integrate the study of subjects relating to Australia and the Asia-Pacific Region with subjects from the student's professional degree, and the fifth year, and sixth year where relevant, completes the professional degree.

In 1998, the following combined degrees in International Studies will be offered for international students undertaking the major on Australia and the Asia-Pacific Region:

Bachelor of Business/Bachelor of Arts in International Studies	B006
Bachelor of Arts in Human Movement Studies and in International Studies	BL15
Bachelor of Arts in Leisure Management and in International Studies	BL17
Bachelor of Arts in Tourism Management and in International Studies	BL16
Bachelor of Building in Construction Economics/Bachelor of Arts in International Studies	AB08
Bachelor of Building in Construction Management/Bachelor of Arts in International Studies	AB09
Bachelor of Land Economics/Bachelor of Arts in International Studies	AB10
Bachelor of Design in Fashion and Textile/ Bachelor of Arts in International Studies	DF03
Bachelor of Design in Interior Design/ Bachelor of Arts in International Studies	DT02
Bachelor of Design in Industrial Design/ Bachelor of Arts in International Studies	DD02

118 UNDERGRADUATE COURSES

Bachelor of Design in Visual Communication/ Bachelor of Arts in International Studies	DV02
Bachelor of Education/Bachelor of Arts in International Studies	TE21
Bachelor of Laws/Bachelor of Arts in International Studies	LL07
Bachelor of Science in Computing Science/ Bachelor of Arts in International Studies	MC05
Bachelor of Science in Mathematics/Bachelor of Arts in International Studies	MM05
Bachelor of Mathematics and Finance/ Bachelor of Arts in International Studies	MM06
Bachelor of Nursing/Bachelor of Arts in International Studies	KN10
Bachelor of Health Science in Acupuncture/ Bachelor of Arts in International Studies	NH01
Bachelor of Science/Bachelor of Arts in International Studies	N004
Bachelor of Arts in Communication (Journalism) and in International Studies	H026
Bachelor of Arts in Communication (Media Arts and Production) and in International Studies	H027
Bachelor of Arts in Communication (Public Communication) and in International Studies	H028
Bachelor of Arts in Communication (Writing and Contemporary Cultures) and in International Studies	H029
Bachelor of Arts in Social Science and in International Studies	H030
Bachelor of Applied Science in Information Studies/Bachelor of Arts in International Studies	H031

Course structure

Year 1

Stage 1

Australian English Language and Culture 1 24cp

Stage 2

Australian English Language and Culture 2 24cp

or

Australian Studies subjects 16cp

and

Enriching language subjects 8cp

or

Australian Studies subjects 24cp

Year 2

Stage 3

Professional degree subjects 24cp

Stage 4

Professional degree subjects 24cp

Year 3

Stage 5

Modernisation and Social Change 8cp

Australia and the Asia-Pacific Region elective 8cp

or

Professional Studies Australia and
Asia-Pacific Region elective 8cp

Professional degree subjects 8cp

Stage 6

Australia and the Asia-Pacific Region elective 8cp

or

Professional Studies Australia and
Asia-Pacific Region elective 8cp

Professional degree subjects 16cp

Year 4

Autumn semester

Australia and the Asia-Pacific Region
electives 16cp

or

Professional Studies Australia and
Asia-Pacific Region electives 16cp

Professional degree subjects 8cp

Spring semester

Australia and the Asia-Pacific Region elective 8cp

or

Professional Studies Australia and
Asia-Pacific Region elective 8cp

Professional degree subjects 16cp

Year 5 (and 6 if relevant)

Autumn semester

Professional degree subjects 24cp

Spring semester

Professional degree subjects 24cp

Further details on the subjects within the professional degree component of the combined degree may be found in the relevant faculty handbook. Queries regarding the International Studies component of the course should be directed to the Institute for International Studies on 9514 1574.

Combined degree students are asked to confirm, during the University enrolment period, the subjects they intend to take throughout the year with the Institute at 9-11 Broadway (next door to the Co-op Bookshop).

The information on the ISIS program of study is correct at the time of going to press. However, the Institute for International Studies reserves the right to make alterations to the content if necessary.

Postgraduate courses

Research degrees

Master of Arts (by thesis)
Doctor of Philosophy

Coursework degrees

Graduate Diploma in International Studies
Master of Arts in International Studies

The Institute for International Studies accepts research students for higher degrees and offers a Graduate Diploma in International Studies and a Master of Arts in International Studies by coursework.

RESEARCH DEGREES

Applications for research degree candidature are welcome from all graduates with an interest in the social, political, economic and cultural changes that have taken place in East Asia, South-East Asia, Latin America, Eastern and Western Europe. Applicants need a First or Second Class Division 1 Honours degree in a relevant field, as well as any other necessary qualifications, including language proficiency.

Research degree (MA and PhD) candidates at UTS normally have a minimum of two supervisors. Research degree students in the Institute should normally expect to have at least one of their supervisors from another part of the University.

Applications for student search places in the Institute should be made through the University Graduate School. However, all applicants are advised to consult Institute staff beforehand.

POSTGRADUATE COURSEWORK DEGREE PROGRAM IN INTERNATIONAL STUDIES

The Postgraduate Coursework Degree Program in International Studies provides graduates from relevant disciplinary backgrounds with the opportunity to study a language and culture other than English. Students study for one year full time (or two years part time) to obtain the Graduate Diploma in International Studies. They may then choose to study for the Master of Arts in International Studies, which involves an additional year of full-time study. The Graduate Diploma is a prerequisite for the Master of Arts in International Studies.

The Graduate Diploma in International Studies and the Master of Arts in International Studies are both fee-paying coursework programs. Students may enrol full time or part time, except for the periods of In-country Study (which are necessarily full time). Students are required to follow one of the following International Studies majors: Argentina, Chile, China, Croatia, France, Germany, Greece, Indonesia, Italy, Japan, Latin America, Malaysia, Mexico, Poland, Russia, Slovenia, South China (Hong Kong and Guangdong), South-East Asia, Spain, Taiwan, Thailand and Ukraine. The choice of major determines the subjects to be studied in the Language and Culture, and Contemporary Society components of the course, as well as the location of In-country Study periods.

The Graduate Diploma in International Studies and Master of Arts in International Studies by coursework programs are offered in conjunction with the Faculty of Humanities and Social Sciences.

Admission requirements

The Graduate Diploma in International Studies is open to candidates with a minimum of a Bachelor's degree and one year professional experience or equivalent.

Admission to the Master of Arts in International Studies is limited to those who

have successfully completed the Graduate Diploma in International Studies.

In general, students are admitted to the International Studies program with no guarantee of entry into a specific major, although every effort is made in trying to meet students' preferences. The Postgraduate Coursework Degree Program in International Studies has no prior language requirement except for the Greece, Poland, Slovenia and Ukraine majors which are restricted to students who have a sound working knowledge of the language of their selected specialisation.

There are different classes available for students with different levels of language proficiency.

Course structure

In the Graduate Diploma program, students are able to choose two electives from specific subjects taught by other faculties, including electives offered by the Faculty of Humanities and Social Sciences; the Faculty of Law; the Faculty of Science; the Faculty of Design, Architecture and Building; and the Institute for International Studies.

In the Master's degree program, students are required to spend a minimum of one semester full time in In-country Study. For the second semester in the Master's program, students have three options to complete their study: they may prolong their period of In-country Study by another semester; they may produce a short dissertation or project report of 15,000 words; or they may engage in a short specialist program of Professional Studies. The dissertation and Professional Studies Specialisation provide the opportunity for students to develop a UTS professional education within an international context.

To graduate with the Graduate Diploma in International Studies, a student is required to have completed 48 credit points of study: 16 credit points (two subjects) of instruction in Language and Culture; 8 credit points of study of Modernisation and Social Change; 8 credit points of study of Contemporary Society; and 16 credit points of approved electives.

To graduate with the Master of Arts in International Studies, a student is required to have first completed the Graduate Diploma in International Studies, followed by one full-time semester (24 credit points) of In-country Study, and then either a second semester of In-country Study, a dissertation in International Studies or a coursework-based Professional Studies Specialisation. Each choice amounts to 24 credit points.

All existing arrangements for the International Studies program apply equally to both the Graduate Diploma in International Studies and the Master of Arts in International Studies.

Individual students' level of language proficiency when they enter the program determines what Language and Culture subjects they study. The Language and Culture, Contemporary Society, and In-country Study subjects listed in the course structure are common subjects across the University.

Graduate Diploma in International Studies

Course code: H075

One year full time

Stage 1

971xxx	Language and Culture 1	8cp
50175	Modernisation and Social Change	8cp
xxxxx	Elective	8cp

Stage 2

972xxx	Language and Culture 2	8cp
976xxx	Contemporary Society	8cp
xxxxx	Elective	8cp

Major

Students are required to follow one of the following International Studies majors: Argentina, Chile, China, Croatia, France, Germany, Greece, Indonesia, Italy, Japan, Latin America, Malaysia, Mexico, Poland, Russia, Slovenia, South China (Hong Kong and Guangdong), South-East Asia, Spain, Taiwan, Thailand and Ukraine. The choice of major dictates the selection of Language and Culture, and Contemporary Society subjects. Further details of majors are available in the Majors in the International Studies Program section of this handbook.

Language and Culture

The following Language and Culture programs are available at UTS: Cantonese, Chinese, Indonesian, Japanese, Malaysian and Spanish. In addition, arrangements have been made for the following language programs to be taught to UTS students at other universities in the Sydney area: Croatian, French, German, Greek, Italian, Korean, Polish, Russian, Slovenian, Thai and Ukrainian. Again the selection of a Language and Culture program is determined by the student's choice of major.

The level of entry to a language program will depend on the individual student's level of language proficiency.

Contemporary Society

All students are required to take Modernisation and Social Change, a subject concerned with comparative social change. In addition, students take an introductory subject on Contemporary Society specific to their majors as follows:

Argentina	Contemporary Latin America
Chile	Contemporary Latin America
China	Contemporary China
Croatia	Contemporary Europe
France	Contemporary Europe
Germany	Contemporary Europe
Greece	Contemporary Europe
Indonesia	Contemporary South-East Asia
Italy	Contemporary Europe
Japan	Contemporary Japan
Korea	Contemporary Korea
Latin America	Contemporary Latin America
Malaysia	Contemporary South-East Asia
Poland	Contemporary Europe
Russia	Contemporary Europe
Slovenia	Contemporary Europe
South China	Chinese East Asia
South-East Asia	Contemporary South-East Asia
Spain	Contemporary Europe
Taiwan	Chinese East Asia
Thailand	Contemporary South-East Asia
Ukraine	Contemporary Europe

Electives

Students can choose 16cp from the following:

Faculty of Design, Architecture and Building

International Project Management

17507	Industry Project Studies 1	12cp
17305	Project Technologies 1	6cp

Faculty of Humanities and Social Sciences

52470	Asian and Pacific Politics	8cp
52472	Gender, Culture and Power	8cp
52471	International Politics	8cp

Faculty of Law

77806	Chinese Law and Legal Systems	6cp
77805	Chinese Trade and Investment Law	6cp
77827	Economic Law in Eastern Europe	6cp
77807	Economic Law in the People's Republic of China	6cp
77824	European Union Law	12cp
77739	Indonesian Trade and Investment Law	6cp
77747	Pacific Rim Dispute Resolution	6cp

Institute for International Studies

976101	Chinese East Asia	8cp
976111	Contemporary China	8cp
976211	Contemporary Japan	8cp
976221	Contemporary Korea	8cp
976501	Contemporary Latin America	8cp
976301	Contemporary South-East Asia	8cp
976401	Contemporary Europe	8cp
973xx	Any Language and Culture Program	8cp
974xx	Any Language and Culture Program	8cp

Faculty of Science, College of Acupuncture

Chinese Medical Philosophy

	Introduction to Traditional Chinese Medicine (three-day intensive course – part of subject 99501)	1cp
99502	Theoretical and Philosophical Foundations of Traditional Acupuncture	6cp
99511	Historical and Advanced Theoretical Foundations of Acupuncture <i>and either</i>	6cp
99528	Introduction to <i>Tai Qi Chuan</i> <i>or</i>	3cp
99543	<i>Qi Gong</i> : Its Use in Acupuncture	3cp

Master of Arts in International Studies

Course code: H081

One year full time

This program is only available to students who have obtained the Graduate Diploma in International Studies at UTS.

Typical full-time program

Stage 1

977xxx In-country Study 1 24cp

Stage 2

either:

978xxx In-country Study 2 24cp

or

979xxx Dissertation 24cp

or

Professional Studies Specialisation 24cp

Major

Students are required to continue with the major that they undertook for the Graduate Diploma in International Studies program. That major dictates the location of In-country Study for the Master's program. The following majors will be available: Argentina, Chile, China, Croatia, France, Germany, Greece, Indonesia, Italy, Japan, Latin America, Malaysia, Mexico, Poland, Russia, Slovenia, South China (Hong Kong and Guangdong), South-East Asia, Spain, Taiwan, Thailand and Ukraine. Further details are available in the Majors in the International Studies Program section of this handbook.

Stage 1

In-country Study

Students are required to spend a semester overseas at an institution of higher education in a country of their major through arrangements made by the Institute. The location of the student's In-country Study is determined by the major chosen for their Graduate Diploma in International Studies. Students may choose to prolong their In-country Study by another semester.

The period of In-country Study focuses on improving the student's understanding of the relevant language and culture. Programs are determined by students' level of language proficiency and must be approved by the Board of Studies of the Institute. Most students, who were beginners or near beginners when

they attended their Language and Culture classes in Sydney, attend classes organised by the Institute at the host institutions. In the first semester of In-country Study, the focus is on the study of language and culture. In the second semester, where numbers permit, the study of language and culture will be geared more to the professional training of the students. Students with higher levels of language competence will be able to attend classes in other subjects: usually those relating to the history, society and politics of their host country, as well as those relating to their professional discipline. All students are assessed on each semester separately and assessment is based on the subjects undertaken at the host institutions, as well as project and essay work administered by the Institute for International Studies.

The costs of tuition in host institutions overseas and travel between Sydney and the designated host institutions are borne by UTS except in cases where a scholarship has been awarded to the student with provision for these costs. Under those circumstances, the funds that would otherwise have been allocated towards the student's tuition and travel will be redirected to support the In-country Study program. In most cases, the cost of living for the period of In-country Study will not exceed the cost of living away from home in Sydney. However, students should be aware that the cost of living in some countries – notably Argentina, France, Germany, Hong Kong, Japan and Taiwan – may be higher than in Sydney.

Before students engage in a period of In-country Study, they may be required to meet appropriate financial and enrolment requirements. They are also required to agree to be governed by the Institute's Conditions of participation for a period of In-country Study and to abide by the rules and regulations of the host institution and the laws of the host country.

Some students may find it difficult to leave or stay away from Australia for a variety of reasons. The Institute will maintain a system of pastoral care. In special cases provision will be made for students to vary their program of study to fit their circumstances. They will be expected to complete their International Studies program by taking subjects from the List of Approved Substitute Subjects in this handbook. Any variation in the International Studies program is subject to the approval of the Board of Studies of the Institute.

Stage 2

In Stage 2 of the course leading to the Master of Arts in International Studies, students have three options: they may prolong their period of In-country Study by another semester; they may return to Sydney and complete a dissertation or project report; or they may undertake a coursework-based Professional Studies Specialisation.

Option 1: In-country Study

Students may opt to spend a second semester at an institution of higher education in a country of their major.

Option 2: Dissertation

Students are required to write a 15,000-word dissertation or project report on a topic related to International Studies. Each student should have two supervisors: one from the Institute and the other from a UTS faculty. The Faculties of Design, Architecture and Building; Education; Humanities and Social Sciences; Law; and Mathematical and Computing Sciences have agreed to participate in this program. It is advisable that the topic of the dissertation be agreed upon beforehand by both the supervisors and the student, and it must also be approved by the Board of Studies of the Institute for International Studies.

Option 3: Professional Studies Specialisation

The Professional Studies Specialisation is intended to complement each student's area of specialisation. The student is required to complete 24 credit points of coursework subjects concentrating on the international aspects of a specific professional education. The number of subjects in each Professional Studies Specialisation will vary with the specific professional education. The Professional Studies Specialisation may also stipulate certain electives in earlier stages of the program. Entry to each Professional Studies Specialisation within this program is subject to the approval of the relevant faculty. Coursework subjects listed as part of a Professional Studies Specialisation are all taught within other UTS programs.

Options within the Professional Studies Specialisation

Professional Studies Specialisations in Education, International Program Management, Law, Statistics, and Chinese Medical Philosophy are currently available.

Education: Faculty of Education

Students undertake 24 credit points of suitable postgraduate coursework subjects with an international focus derived from the MEd in Adult Education, the MEd in Teacher Education, the MA in Children's Literature and Literacy, or the MA in TESOL. The precise sequence is individually negotiated for each student with the appropriate MA or MEd Course Coordinator.

International Project Management: Faculty of Design, Architecture and Building

Prerequisite: International Project Management in the Graduate Diploma in International Studies

Project Process 1	6cp
Project Process 2	6cp
Project Process 3	6cp
Project Process 4	6cp

Law: Faculty of Law

Students must complete 24cp from the following:

77822	International Banking and Finance Law	12cp
77804	International Business Transactions	6cp
77814	International Commercial Arbitration	6cp
77717	International Commercial Dispute Resolution	12cp
77802	International Economic Law	6cp
77809	International Monetary Law	6cp
79762	International Taxation 1	6cp
79707	International Taxation 2	6cp
77801	International Trade Law	12cp
77828	Private International Law	12cp

Chinese Medical Philosophy: Faculty of Science

Prerequisite: Chinese Medical Philosophy in the Graduate Diploma in International Studies

xxxxx	Project Dissertation	24cp
-------	----------------------	------

Language studies

The Institute for International Studies organises and coordinates the teaching of all languages other than English to all UTS students. All students intending to take language studies as part of their degree need to enrol through the Institute, even if the language concerned is not taught on UTS campuses. With the permission of their faculty, students may study languages other than English as electives in any UTS degree. All language subjects are taught over one semester and are worth eight credit points.

UTS students can access language subjects in one of the following ways:

- as part of a combined degree or as part of the postgraduate coursework degree program in International Studies;
- as elective subjects in any other UTS degree, with faculty approval;
- as non-award subjects.

Language studies subjects are generally open to UTS students who wish to study languages for credit within their current degree. UTS students who wish to engage in language studies, but not for credit, are admitted as fee-paying students. Students from other institutions can enrol in language studies subjects as cross-institutional students, and they should contact the Non-Award Studies Officer at the UTS Information Services of the University. The telephone number is 9514 1559.

The Institute for International Studies has developed its own Language and Culture programs, together with the Insearch Language Centre, as part of the International Studies program. It has also made arrangements with other universities in the Sydney area for UTS students to be taught in specific language programs. The Institute participates in the Asian Languages Consortium of Sydney Universities.

The Institute is offering Language and Culture programs in Cantonese, Chinese, Indonesian, Japanese, Malaysian and Spanish on UTS campuses through arrangements with the Insearch Language Centre. Higher levels of these languages may be offered through arrangements with other universities in the Sydney area.

Croatian, French, German, Greek, Italian, Korean, Polish, Russian, Slovenian, Thai and Ukrainian are offered to UTS students through arrangements that have been made with other Sydney universities.

In addition, it is always possible for individual arrangements to be made to enable UTS students to study other language programs depending on availability.

In all cases, classes will only be taught at UTS if student numbers permit. In some cases, students may need to be prepared to travel to other campuses in the Sydney area.

Enrolment procedures for language subjects

Combined degree students in the International Studies program and students in the Postgraduate Coursework Degree Program are required to enrol in language subjects.

Other UTS students who wish to study a language subject as a credited elective in their current degree need to obtain approval from both their faculty and the Institute for International Studies before they enrol in the subject.

Enrolment procedures for language subjects as credited electives are described under the Electives and non-award studies heading in the Institute Information section of this handbook.

The Institute starts pre-enrolment from the October of the year preceding enrolment. Students are encouraged to contact the Institute as soon as possible.

Credit points and workload

Each language subject is valued at eight credit points per semester.

To cater for the different needs of students, each language program has different points of entry depending on a student's language skills. The beginners' levels will necessarily concentrate more on basic communication skills. The higher levels of each language program will introduce students to literature and culture in the appropriate vernacular.

Most Language and Culture subjects taught on UTS campuses consist of six contact hours per week. Languages taught through arrangements with other universities

normally consist of four to six contact hours per week distributed across two to three days. Language subjects are open to undergraduate, postgraduate and non-degree students. All UTS students who wish to study a language as part of their degree are required to proceed through the Institute.

LANGUAGE PROGRAMS

Arabic

Arabic is offered to UTS students through an arrangement with the University of Sydney. Students interested in this language program are required to contact the Institute for International Studies for further information.

Cantonese Language and Culture

Cantonese Language and Culture A

Cantonese A is a four-subject language program for students who are complete beginners.¹ The program aims at developing students' basic communicative competence and linguistic skills in general social interactions where Cantonese is used. It also deals with Chinese characters and Cantonese discourse features. The teaching incorporates an introduction to Cantonese culture and helps students to appreciate the wider cultural ramifications of Cantonese in various contexts. The course is organised around communicative and functional themes so that students can learn the language in relevant social situations.

Each subject will be covered in one semester (13 weeks). There are six hours of language classes plus a one-hour session of language laboratory work per week. The teaching approach adopted is 'communicative' and students are expected to participate actively in all classroom activities so as to maximise the acquisition of language skills.

¹ In general, students who speak another Chinese language, and who have achieved a high proficiency in reading and writing Chinese are advised to take Cantonese B, which is a two-subject language program specifically designed to improve students' oral and aural skills in Cantonese.

Cantonese Language and Culture A-1

8cp; 1st semester, 6hpw; prerequisite: nil

Cantonese A-1 is the first subject in the Cantonese A program. It is designed to provide students who have no prior knowledge of Cantonese with basic survival skills in language and culture, and the ability to undertake In-country Study in South China.

This subject aims at developing in students a survival communicative ability in basic social interactions. It also deals with the basic language structures and devices of Cantonese. Students will be taught the basic structures of Chinese writing and are expected to know about 150 Chinese characters by the end of the subject.

Cantonese A-1 consists of 78 hours of classroom instruction, involving many interactive group and pair-work activities. Audiovisual equipment and computers will be used to facilitate teaching and learning. A communicative approach is adopted for classroom instruction and students are expected to participate actively in all classroom activities in the process of acquiring language skills. The teaching incorporates an introduction to Cantonese culture and helps students to appreciate the wider cultural ramifications of Cantonese in various contexts.

Cantonese Language and Culture A-2

8cp; 2nd semester, 6hpw; prerequisite:

Cantonese Language and Culture A-1

Cantonese A-2 is the second subject in the Cantonese A program. It is designed to provide students who have no prior knowledge of Cantonese with basic survival skills in language and culture, and the ability to undertake In-country Study in South China.

This subject aims at developing in students a communicative and linguistic competence in basic social interactions. It also deals with some of the basic structures and devices of Cantonese. Students will be taught the basic structures of Chinese writing and are expected to know about 300 Chinese characters by the end of the subject.

Cantonese A-2 consists of 78 hours of classroom instruction, involving many interactive group and pair-work activities. Audiovisual equipment and computers will be used to facilitate teaching and learning. A communicative approach is adopted for classroom instruction and students are expected to participate actively in all classroom activities in the process of acquiring language

skills. The teaching incorporates an introduction to Cantonese culture and helps students to appreciate the wider cultural ramifications of Cantonese in various contexts.

Cantonese Language and Culture A-3

8cp; 1st semester, 6hpw; prerequisite: Cantonese Language and Culture A-2

Cantonese A-3 is the third subject in the Cantonese A program. It is designed to provide students who have no prior knowledge of Cantonese with basic survival skills in language and culture, and the ability to undertake In-country Study in South China.

This subject aims at developing in students a communicative and linguistic competence in general social interactions. It also deals with the language structures and devices of Cantonese. Discourse features such as registers and polite forms will be discussed. More Cantonese vocabulary and idiomatic expressions will be introduced. Students are expected to know about 500 Chinese characters by the end of the subject.

Cantonese A-3 consists of 78 hours of classroom instruction, involving many interactive group and pair-work activities. Audiovisual equipment and computers will be used to facilitate teaching and learning. A communicative approach is adopted for classroom instruction and students are expected to participate actively in all classroom activities in the process of acquiring language skills. The teaching incorporates an introduction to Cantonese culture and helps students to appreciate the wider cultural ramifications of Cantonese in various contexts.

Cantonese Language and Culture A-4

8cp; 2nd semester, 6hpw; prerequisite: Cantonese Language and Culture A-3

Cantonese A-4 is the last subject in the Cantonese A program. It is designed to provide students who have no prior knowledge of Cantonese with basic survival skills in language and culture, and the ability to undertake In-country Study in South China.

This subject aims at developing in students a communicative and linguistic competence in general social interactions. It deals with the more complex language structures and devices of Cantonese. A number of Cantonese discourse features will be discussed. More Cantonese vocabulary and idiomatic expressions will be introduced. Students are expected to know about 800 Chinese characters by the end of the subject.

Cantonese A-4 consists of 78 hours of classroom instruction, involving many interactive group and pair-work activities. Audiovisual equipment and computers will be used to facilitate teaching and learning. A communicative approach is adopted for classroom instruction and students are expected to participate actively in all classroom activities in the process of acquiring language skills. The teaching incorporates an introduction to Cantonese culture and helps students to appreciate the wider cultural ramifications of Cantonese in various contexts.

Cantonese Language and Culture B

Cantonese B is a two-subject language program for students who speak at least one Chinese language other than Cantonese and have achieved a high proficiency in Chinese writing. The program is specifically designed to improve students' oral and listening skills in Cantonese so as to provide students with the necessary linguistic competence for a period of study and work in South China. It will also provide students with the basic foundation and skills for continuing their learning of Cantonese.

Each subject in the program consists of 52 hours of classroom instruction, and involves many interactive group and pair-work activities. Language items such as vocabulary and phonological features) related to the communication goals, and socio-cultural items (such as kinships and different socio-cultural contexts) related to the socio-cultural goals, will receive equal importance. Audiovisual equipment and computers will be used to facilitate the teaching and learning of the language. The teaching approach adopted is 'communicative' and students are expected to participate fully in all classroom activities in the process of acquiring language skills.

The course is organised around themes and topics so that students learn Cantonese in relevant social situations. The program incorporates an introduction to Cantonese culture and helps students to appreciate the wider cultural ramifications of Cantonese in various contexts.

Cantonese Language and Culture B-1

8cp; 1st semester, 4hpw; prerequisite: a working knowledge of one of the Chinese languages

Cantonese B-1 is the first of a two-subject language program for students who have a working knowledge of at least one Chinese language to prepare them for a year of In-country Study in South China.

This subject aims at developing the students' communicative and linguistic competence in general social interactions where Cantonese is used. The Yale romanisation for transcribing Cantonese and pronunciation will be discussed in class. Situational Cantonese usages in different contexts are the main focus of class instruction. The teaching incorporates an introduction to Cantonese culture and helps students to appreciate the wider cultural ramifications of Cantonese in various contexts.

Cantonese B-1 consists of 52 contact hours of classroom instruction, involving many interactive group and pair-work activities. Audiovisual equipment and computers will be used to facilitate teaching and learning. The teaching approach adopted is 'communicative' and students are expected to participate actively in all classroom activities in the process of acquiring language skills.

Cantonese Language and Culture B-2

8cp; 2nd semester, 4hpw; prerequisite: Cantonese Language and Culture B-1

Cantonese B-2 is the second of a two-subject language program for students who have a working knowledge of at least one Chinese language to prepare them for a year of In-country Study in South China.

This subject aims at further developing the students' communicative and linguistic competence in general social interactions where Cantonese is used. Situational Cantonese usages and vocabulary in different contexts are the main focus of class instruction. Discourse features of Cantonese will also be discussed. The teaching incorporates an introduction to Cantonese culture and helps students to appreciate the wider cultural ramifications of Cantonese in various contexts.

This subject consists of 52 contact hours of classroom instruction, involving many interactive group and pair-work activities. Audiovisual equipment and computers will be used to facilitate teaching and learning. The teaching approach adopted is 'communicative' and students are expected to participate actively in all classroom activities in the process of acquiring language skills.

Chinese Language and Culture

The Chinese program is open to students who are either complete beginners, who first learnt Chinese at secondary school level in Australia or who already have a working knowledge of Chinese characters and communicative competence in a Chinese

language other than Modern Standard Chinese. There are three points of entry into this program: Chinese 1 for complete beginners, Chinese 3 for students who have successfully completed HSC 2/3-unit Chinese and Chinese 7 for students who have a working knowledge of Chinese characters as well as communicative competence in a Chinese language other than Modern Standard Chinese. Students take four consecutive units in the program, usually either units 1-4, 3-6 or 7-10, determined by their point of entry. Other programs may be negotiated according to the student's level of proficiency.

The Chinese language program is designed to provide students with the communicative skills necessary to undertake In-country Study in China. A communicative approach is adopted for classroom instruction and students are expected to participate fully in class activities in the process of acquiring practical language skills. The teaching incorporates an introduction to Chinese culture and helps students to appreciate the wider cultural ramifications of Chinese in various contexts. The program will lay a solid foundation for further cultural studies in Chinese.

Chinese Language and Culture 1

8cp; 6hpw; prerequisite: nil

Chinese 1 aims at developing in students a survival communicative ability in basic social interactions. It teaches students *Pinyin*, the official transcription system, as a guide to the pronunciation of the Chinese language, and some basic structures and devices of the language. Students are expected to know about 300 Chinese characters by the end of this unit.

Chinese Language and Culture 2

8cp; 1st semester, 6hpw; prerequisite: Chinese Language and Culture 1

Chinese 2 aims continues to develop in students a survival communicative ability in basic social interactions. It also introduces students to some of the basic structures and devices of the language. Students are expected to know about 600-800 Chinese characters by the end of this unit.

Chinese Language and Culture 3

8cp; 2nd semester, 6hpw; prerequisite: Chinese Language and Culture 2 or HSC Chinese

Chinese 3 is the entry point for students who have completed HSC 2/3-unit Chinese and who first learnt Chinese at school in Australia.

Chinese 3 aims at further developing students' oral communicative competence in basic social interactions. More written texts will be gradually introduced to enhance the ability of students to use Chinese characters. The basic structures and devices of the language will be reinforced. Students are expected to know about 1,200 Chinese characters by the end of this unit.

Chinese Language and Culture 4

8cp; 2nd semester, 6hpw; prerequisite: Chinese Language and Culture 3

Chinese 4 is the second unit for students who have completed HSC 2/3-unit Chinese.

Chinese 4 aims at further developing students' communicative competence in basic social interactions. More written texts are introduced to enhance the ability of students to use Chinese characters. The basic structures and devices of the language are also reinforced. Students are expected to know about 1,600 Chinese characters by the end of this unit.

Chinese Language and Culture 5

8cp; 1st semester, 6hpw; prerequisite: Chinese Language and Culture 4

Chinese 5 is the third unit for students who first learnt Chinese at school in Australia and obtained HSC 2/3-unit Chinese.

Chinese 5 aims at further developing students' communicative competence in general social interactions. While reinforcing the macro-skills of reading, writing, listening and speaking, this unit will focus on practical writing skills. Students are expected to know about 2,000 Chinese characters by the end of this unit.

Chinese Language and Culture 6

8cp; 2nd semester, 6hpw; prerequisite: Chinese Language and Culture 5

Chinese 6 is the fourth subject for students who have obtained HSC 2/3-unit Chinese with basic communicative skills and the ability to undertake In-country Study in China.

Chinese 6 aims at further developing students' communicative competence in general social interactions. While reinforcing basic structures and devices of the language, this unit will further develop students' writing skills. Students are expected to know about 2,500 Chinese characters by the end of this unit.

Chinese Language and Culture 7

8cp; 4hpw; prerequisite: a working knowledge of Chinese characters as well as communicative competence in a Chinese language other than Modern Standard Chinese.

Chinese 7 is for students who have a working knowledge of Chinese characters as well as communicative competence in a Chinese language other than Modern Standard Chinese.

This unit aims at developing communicative competence to meet students' needs in social and professional interactions where Modern Standard Chinese (also known as Mandarin, *Putonghua* or *Guoyu*) is used. Simplified characters, pronunciation, intonation and situational Chinese usages are the focus of class instruction.

Chinese Language and Culture 8

8cp; 4hpw; prerequisite: Chinese Language and Culture 7 or equivalent

This unit aims at developing a communicative competence at a more sophisticated level. Students are exposed to a range of Chinese texts in varied socio-cultural contexts to master Chinese for different purposes, and are provided with opportunities to further improve speaking and listening skills through discussions of the texts and making cross-cultural comparisons.

Chinese Language and Culture 9

8cp; 4hpw; prerequisite: Chinese Language and Culture 8 or equivalent

This unit aims at developing in students a high level of communicative competence required for understanding various electronic and published media articles, correspondence and texts related to contemporary society. Modern Standard Chinese (also known as Mandarin, *Putonghua* or *Guoyu*) is used. Students are exposed to a range of Chinese texts in order to master the use of Chinese for different purposes, and are provided with opportunities to maintain speaking and listening skills through discussion of texts.

Chinese Language and Culture 10

8cp; 4hpw; prerequisite: Chinese Language and Culture 9 or equivalent

This unit aims at further developing in students a high level of communicative competence in reading and writing to meet students' needs in social and professional interactions. Modern Standard Chinese (also known as Mandarin, *Putonghua* or *Guoyu*) is

used. Students are exposed to a range of diverse texts from modern Chinese literature, history, language and culture in order to master the use of written Chinese for different purposes, and are provided with further opportunities to maintain speaking and listening skills through discussion of the texts.

Croatian

Croatian language is offered to UTS students through an arrangement with Macquarie University. Students are placed in classes appropriate to their level of competence with particular emphasis on furthering pronunciation and writing skills and learning about the history of the Croatian language.

French Language and Culture

French Language and Culture is offered at the UTS City campus. There are two main points of entry: the first for complete beginners, and the second for students who have successfully completed HSC-level French or equivalent. The French subjects develop communicative skills in listening, speaking, reading and writing, and introduce students to literary texts. Students also learn about French culture and contemporary society.

German Language and Culture

German Language and Culture is offered at the UTS City Campus. There are two main points of entry: the first for complete beginners, and the second for students who have completed HSC-level German or equivalent. The German subjects develop communicative skills in listening, speaking, reading and writing, and introduce students to literary texts. Students also learn about German culture and contemporary society.

Greek

Greek is offered to UTS students through arrangements with other universities in Sydney. Students are placed in classes appropriate to their level of competence. The program focuses on furthering writing and oral skills in contemporary Greek and learning about literature, society and culture.

Hebrew

Hebrew is offered to UTS students through an arrangement with the University of Sydney. Students interested in this language program are required to contact the Institute for International Studies for further information.

Hindi

Hindi is offered to UTS students through an arrangement with the University of Sydney subject to availability. Students interested in this language program are required to contact the Institute for International Studies for further information.

Indonesian Language and Culture

Indonesian is a language and culture program for students who are either complete beginners or who first learnt Indonesian at school in Australia. In general, there are two points of entry: the first for complete beginners and the second for students who have successfully completed HSC-level Indonesian. Students take four units in the program: usually either units 1–4 (beginners) or 3–6 (post-HSC), determined by their point of entry.

The program is organised according to a series of themes that cover a broad range of communicative situations relevant to daily social interaction in Indonesia. The focus is on the development of speaking, listening, reading and writing skills appropriate to the situations that students are likely to encounter. Vocabulary and grammar are taught using written and audiovisual materials that cover a range of themes and situations. Upon successful completion of the program, students are expected to be able to communicate about familiar things, events and opinions, and to have developed skills and strategies for continuing their learning of the language in Indonesia. Those students with prior knowledge of Indonesian, and who will be entering the program at a higher level, are expected to be able to communicate comfortably on a wide range of themes with the ability to adjust their language according to social variables such as formality, age and status.

Indonesian Language and Culture 1

8cp; 1st semester, 6hpw; prerequisite: nil

Indonesian 1 is the first in a series of four units for students with no prior knowledge of Indonesian. By the end of the subject, students are expected to have achieved elementary proficiency and be able to satisfy immediate needs using learnt utterances and phrases relating to the following 10 themes: self and family; direction and location; time; food and drink; buying and selling; description;

archipelago and continent; travel and transport; media and the press; and love and sex.

Students are expected to develop a vocabulary of about 800–1,000 words, a knowledge of basic word-order patterns, and a familiarity with the alphabet and pronunciation patterns. This subject prepares people to exchange basic personal information using spelling and numeracy skills for names, addresses and time references etc.; engage in brief conversations within the range of themes covered; and express immediate needs with socially appropriate phrases. Students should be able to understand a limited amount of everyday written language e.g. on signs and in menus.

Indonesian Language and Culture 2

8cp; 2nd semester, 6hpw; prerequisite: Indonesian Language and Culture 1

Indonesian 2 is the second in a series of four units for students with no prior knowledge of Indonesian. By the end of the subject, students are expected to have achieved minimum survival proficiency, and be able to satisfy basic survival needs and minimum courtesy requirements relating to the following 10 themes: health; house and home; contacts and appointments; education and study; career and occupations; city and village; religion and beliefs; personalities and biography; letters; and Australia–Indonesia relations.

Students are expected to develop a vocabulary of about 1,600–2,000 words, a knowledge of common word-order patterns and the ability to recognise common affixational patterns. This subject prepares students to make simple appointments and arrangements with people, exchange personal background information, engage in five- to 10-minute conversations on the themes covered, and express feelings, likes and dislikes. Students should be able to understand short, practical pieces of written information, such as familiar signs, commands and timetables, and develop skills for reading longer, less familiar written forms.

Indonesian Language and Culture 3

8cp; 1st semester, 6hpw; prerequisite: Indonesian Language and Culture 2 or HSC Indonesian

Indonesian 3 is the third in a series of four units for students with no prior knowledge of Indonesian, or first in a series of four units for students who have successfully completed HSC-level Indonesian. By the end of the subject, students are expected to have achieved survival proficiency, and be able to satisfy

survival needs and limited social demands relating to the following themes: personal relations; education – young generation; students; politics; ‘pop’ culture; religion and beliefs; tourism and its influences; trade; and economics and business.

Students are expected to develop a vocabulary of about 3,000 words by the end of the subject, a knowledge of common word-order patterns, and the ability to recognise, predict and use common affixational patterns. This subject prepares students to engage in short conversations on familiar issues without undue hesitation and with an ability to express their opinion. Students should also be able to comprehend simple texts, such as messages, instructions and directions, and write simple formulaic letters.

Indonesian Language and Culture 4

8cp; 2nd semester, 6hpw; prerequisite: Indonesian Language and Culture 3

Indonesian 4 is the fourth in a series of four units for students with no prior knowledge of Indonesian, or second in a series of four units for students who have successfully completed HSC-level Indonesian. By the end of the subject, students are expected to have begun to develop minimum social proficiency, and be able to satisfy limited routine social and work demands. The subject covers the following themes: the role of women; employment/labour; employers; mainstream/marginal cultures; literature; unity and diversity (multiculturalism); the environment; and Australia–Indonesia relations.

Students are expected to have developed a vocabulary of about 4,000 words by the end of the subject. They should also have developed an ability to recognise, predict and use common word-order and affixational patterns, and to participate in a limited range of social situations with appropriate language. This subject prepares students to be able to discuss familiar events and topics, and give opinions without undue hesitation and with the ability to justify themselves. Students should also be able to deal with short texts and correspond with Indonesians on familiar topics.

Indonesian Language and Culture 5

8cp; 1st semester, 6hpw; prerequisite: Indonesian Language and Culture 4

Indonesian 5 is the third in a series of four units for students who have successfully completed HSC-level Indonesian. By the end of the subject, students are expected to have developed

minimum social proficiency, and be able to satisfy routine social and limited work demands. The subject covers the following themes: perceptions of the past; the origin of the New Order; aspirations; achievements; problems; political culture and participation; class and social stratification; and gender.

Students completing the subject should have a vocabulary of about 5,000 words. They should have the ability to recognise and reflect on ways in which vocabulary and grammatical patterns vary in different situational contexts, and how choices in grammar and vocabulary can convey the point of view of the writer and speaker beyond the basic transmission of information. This subject prepares students to discuss a range of social topics and a limited range of work topics, and present rudimentary arguments or points of view expressed with socially appropriate phrases to limit possible misunderstanding or offence. Students should also be able to understand the general thread of articles and documents on familiar topics, and write short texts, such as letters and instructions.

Indonesian Language and Culture 6

8cp; 2nd semester, 6hpw; prerequisite: Indonesian Language and Culture 5

Indonesian 6 is the fourth in a series of four units for students who have successfully completed HSC-level Indonesian. By the end of the subject, students are expected to have begun to develop a minimum vocational language proficiency, and be able to satisfy all routine social demands and a significant range of work demands. The subject covers the following themes: social and cultural pluralism; national and economic development; science; technical and scientific development; religion and popular culture; and internationalisation.

Students should have a vocabulary of about 6,000 words by the end of the subject. They should also have the ability to vary their language appropriately in accordance with a range of social and work situations, and be able to recognise and manipulate vocabulary and grammatical patterns. This subject prepares students to be able to present arguments or points of view, with the ability to frame them in a style that is appropriate to the social, cultural and interpersonal factors present. Students should also be able to understand articles and documents on familiar topics, and write short texts, such as letters, descriptions and simple explanations.

Italian Language and Culture

Italian Language and Culture is offered at the UTS City campus. There are two main points of entry: the first for complete beginners, and the second for students who have successfully completed HSC-level Italian. The Italian subjects develop communicative skills in listening, speaking, reading and writing, and introduce students to literary texts. Students also learn about Italian culture and contemporary society.

Japanese Language and Culture

This program comprises six units offered in two main streams: beginners and post-HSC. There are two main points of entry into the Japanese Language and Culture Program. Students with no prior experience of the language enter the program at Japanese 1, while students with HSC-level Japanese or equivalent are required to enter the program at the post-HSC level (Japanese 3).

The program enables students to develop the skills to communicate in everyday situations in order to live, study and work in a Japanese-speaking environment, or interact with Japanese people in a social, university or work-related context. The emphasis is on the development of communication skills, particularly speaking and listening, with an increased focus on reading and writing skills at the post-HSC level. The study of socio-cultural aspects of Japan is an integrated and essential part of the language program. It is intended that students have the opportunity to live and study in Japan after the successful completion of one or two years of study.

Japanese Language and Culture I

8cp; 1st semester, 6hpw; prerequisite: nil

This is the first subject in the Japanese Language and Culture program. It is designed as the first step in providing students with no prior knowledge of Japanese with the basic survival language skills and socio-cultural awareness to enable them to undertake In-country Study in Japan.

While focusing primarily on the development of speaking and listening skills, this subject also provides a working knowledge of the *hiragana* and *katakana* scripts and approximately 50 *kanji*. Socio-cultural aspects are integrated into the program as they relate to the need for students to learn to use the language appropriately in various social and cultural contexts.

Japanese Language and Culture 2

8cp; 2nd semester, 6hpw; prerequisite: Japanese Language and Culture 1

This is the second in a series of four units for students with no prior knowledge of the Japanese language. By the completion of this subject, student should be able to demonstrate the language and socio-cultural skills required to establish and maintain relationships in social or work-related spheres, and fulfil basic survival needs in a Japanese-speaking environment.

Emphasis is given to the development of speaking and listening skills, but students will also further develop their reading and writing skills. Besides *kana* they will know approximately 150 *kanji* by the end of the unit. Socio-cultural aspects are integrated into the program as they relate to the need for students to learn to use the language appropriately in various social and cultural contexts.

Japanese Language and Culture 3

8cp; 1st semester, 6hpw; prerequisite: Japanese Language and Culture 2 or HSC Japanese

Japanese 3 is the third in a series of four units for students with no prior knowledge of the Japanese language, or first in a series of four units for students who have successfully completed HSC-level Japanese. By the end of the subject, students are expected to have achieved survival proficiency, and be able to satisfy survival needs and limited social demands relating to topics and situations covered.

At the end of the subject, students are expected to have developed their listening, speaking, reading and writing skills in order to be able to communicate in everyday situations, and be able to demonstrate an awareness of the social implications of language and behaviour.

It is expected that students will know approximately 250 *kanji* by the end of the unit.

Japanese Language and Culture 4

8cp; 2nd semester, 6hpw; prerequisite: Japanese Language and Culture 3

Japanese 4 is the fourth in a series of four units for beginners. It is also the second in a series of four units for those who have successfully completed the HSC-level course or its equivalent and aim to further develop Japanese listening, speaking, reading and writing skills. By the end of the subject, students are expected to have achieved limited social proficiency, and be able to interact in limited social, study and work contexts with

Japanese speakers in Japan or Australia. They will also have learnt approximately 350 *kanji*.

Japanese Language and Culture 5

8cp; 1st semester, 6hpw; prerequisite: Japanese Language and Culture 4

Japanese 5 is the third in a series of four units in the post-HSC series, and is for those who have successfully completed either Japanese 4 or its equivalent and aim to further develop listening, speaking, reading, writing and cultural skills. By the end of the subject, students are expected to have achieved limited social proficiency, and be able to satisfy routine social and limited work demands. The emphasis is on the development of the language and of the cultural sensitivity required in both formal and informal situations. By the end of the subject, students are expected to be able to read and write approximately 470 *kanji*.

Japanese Language and Culture 6

8cp; 2nd semester, 6hpw; prerequisite: Japanese Language and Culture 5

Japanese 6 is the final subject in a series of four units in the post-HSC series and is for those who have successfully completed either Japanese 5 or its equivalent. By the end of this subject, students are expected to have achieved minimal vocational proficiency, and be able to speak the language with sufficient structural accuracy and vocabulary to participate effectively in many formal and informal conversations on practical, social and limited vocational topics. The emphasis is on the development of the language and of the cultural sensitivity required in both formal and informal situations. By the end of the subject, students should be able to read simple prose and read and write approximately 590 *kanji*.

Korean

Korean is offered to UTS students through the University of New South Wales. The program has two levels of entry: the first for beginners who have had no previous exposure to Korean and the second for those who have completed HSC-level Korean. If student numbers permit, classes will be available on UTS campuses.

Latin

Latin is offered to UTS students through an arrangement with the University of Sydney. Students interested in this language program are required to contact the Institute for International Studies for further information.

Malaysian Language and Culture

This is a Language and Culture Program for students who intend to study Malaysian as part of a combined degree through the Institute for International Studies or as an elective for credit within their current degree. In general, there are two points of entry: the first for complete beginners, the second for students who have a basic knowledge of Malaysian through previous experience or study. Students take four units in the program, usually either units 1–4 (beginners) or 3–6 (students with previous knowledge), determined by their point of entry.

The program is organised according to a series of themes that cover a broad range of communicative situations relevant to daily interaction in Malaysia. The focus is on the development of speaking, listening, reading and writing skills appropriate to the situations that students are likely to encounter. Vocabulary and grammar are learnt in the course, which is centred on written and audiovisual materials encompassing a range of themes and situations. Upon successful completion of the program, students are expected to be able to communicate about familiar things, events and opinions and to have developed skills and strategies for continuing their learning of the language in Malaysia. Those students with prior knowledge of Malaysian entering the program at a higher level are expected to communicate comfortably on a wide range of themes with the ability to adjust their language according to social variables such as formality, age and status.

Due to the recognised similarities between Malaysian and Indonesian the Language and Culture Programs units 1–3 will cover the structures and functions common to both languages while identifying the differentiating features in terms of vocabulary and grammar. Essentially two streams will be created and each group will have access to authentic material. Malaysian units 4–6 will be conducted separately and will focus on the study of Malaysian at an advanced level.

In exceptional circumstances, students with advanced competence in Malaysian will be excluded from this Language and Culture program, and required to substitute other appropriate units from a list of approved subjects or units. These units may be other units on offer in the International Studies

program, including those related to the study of contemporary society, or those concerned with the study of another language and culture. The approval of the Board of Studies of the Institute is required for any student to vary any subject of instruction in the International Studies program.

Malaysian Language and Culture 1

8cp; 1st semester, 6hpw; prerequisite: nil

Malaysian 1 is the first in a series of four units for students with no prior knowledge of the language. By the end of the subject, students are expected to have achieved elementary proficiency and be able to satisfy immediate needs using learnt utterances and phrases relating to the following 10 themes: self and family; direction and location; time; food and drink; buying and selling; description; archipelago and continent; travel and transport; media and the press; and love and sex.

Students are expected to develop a vocabulary of about 800–1,000 words, a knowledge of basic word order patterns and familiarity with the alphabet and pronunciation patterns. This subject prepares people to exchange basic personal information using spelling and numeracy skills for names, addresses and time references, to engage in brief conversations within the range of themes covered, and express immediate needs with socially appropriate phrases. Students should be able to understand a limited range of everyday written language, such as signs and items and prices on menus.

Malaysian Language and Culture 2

8cp; 2nd semester, 6hpw; prerequisite: Malaysian Language and Culture 1

Malaysian 2 is the second in a series of four units for students with no prior knowledge of Malaysian. By the end of the subject, students are expected to have achieved minimum survival proficiency and to be able to satisfy basic survival needs and minimum courtesy requirements relating to the following 10 themes: health; house and home; contacts and appointments; education and study; career and occupations; city and village; religion and belief; personalities and biography; letters; and Australia–Malaysia relations.

Students are expected to develop a vocabulary of about 1,600–2,000 words, a knowledge of common word order patterns and the ability to recognise common affixational patterns. This subject prepares students to make simple

appointments and arrangements with people, exchange personal background information, engage in five- to 10-minute conversations on the themes covered and express limited feelings, likes and dislikes. Students should be able to understand short practical written information, such as familiar signs, commands and timetables and develop skills for reading longer, less familiar written forms.

Malaysian Language and Culture 3

8cp; 1st semester, 6hpw; prerequisite: Malaysian Language and Culture 2

Malaysian 3 is the third in a series of four units for students with no prior knowledge of Malaysian, or first in a series of four for students who have prior knowledge or experience in Malaysian. By the end of the subject, students are expected to have achieved survival proficiency and be able to satisfy survival needs and limited social demands relating to the following themes: personal relations; education – young generation; students; politics; ‘pop’ culture; religion and belief; tourism and its influences; trade; economics; and business.

Students are expected to develop a vocabulary of about 3,000 words by the end of the subject, a knowledge of common word order patterns and the ability to recognise, predict and use common affixational patterns. This subject prepares students to engage in short conversations on familiar issues without undue hesitation and with a limited ability to express opinions. Students should also be able to comprehend simple texts, such as messages, instructions and directions and write simple formulaic letters.

Malaysian Language and Culture 4

8cp; 2nd semester, 6hpw; prerequisite: Malaysian Language and Culture 3

Malaysian 4 is the fourth in a series of four units for students with no prior knowledge of Malaysian, or second in a series of four units for students who have prior knowledge or experience of Malaysian. By the end of the subject, students are expected to have begun to develop ‘minimum social proficiency’ and be able to satisfy limited routine social and work demands demonstrating the following themes: role of women; employment/labour; employers; mainstream/marginal cultures; literature; unity and diversity (multiculturalism); the environment; and Australia-Malaysia relations.

Students are expected to have developed a vocabulary of about 4,000 words and an ability to recognise, predict and use common word order and affixational patterns and recognise and respond to a limited range of social situations. This subject prepares students to discuss familiar events and topics and give opinions without undue hesitation and with a limited ability to justify these opinions. Students should also be able to deal with short texts and correspond with Malaysians on familiar topics.

Malaysian Language and Culture 5

8cp; 1st semester, 6hpw; prerequisite: Malaysian Language and Culture 4

Malaysian 5 is the third in a series of four units for students who have had prior experience of Malaysian. By the end of the subject, students are expected to have developed minimum social proficiency and be able to satisfy routine social and limited work demands. The subject covers the following themes: perceptions of the past; aspirations, achievements, problems; political culture and participation; class and social stratification; and gender.

Students completing the subject should have a vocabulary of about 5,000 words, and the ability to recognise and reflect on ways in which vocabulary and grammatical patterns vary according to situation, and how choices in grammar and vocabulary can convey the point of view of the reader and speaker beyond the basic transmission of information. This subject prepares students to discuss a range of social topics and limited range of work topics and present rudimentary arguments or points of view expressed with socially appropriate phrases to limit possible misunderstanding or offence. Students should also be able to understand the general thread of articles and documents on familiar topics and write short texts, such as letters and instructions.

Malaysian Language and Culture 6

8cp; 2nd semester, 6hpw; prerequisite: Malaysian Language and Culture 5

Malaysian 6 is the fourth in a series of four units for students who have had prior experience of Malaysian. By the end of the subject, students are expected to have begun to develop minimum vocational proficiency and to be able to satisfy all routine social demands and a significant range of work demands relating to the following themes: social and cultural pluralism; national and

economic development; science; technical and scientific development; religion and popular culture; and internationalisation.

Students should have a vocabulary of about 6,000 words by the end of the subject, together with the ability to vary their language appropriately in accordance with a limited range of social and work situations. They should also be able to recognise and manipulate a choice of vocabulary and grammatical patterns on a limited level and to convey certain points of view. This subject prepares students to discuss a range of social topics and limited range of work topics, to present arguments or points of view, and to frame these in a style appropriate to the social, cultural and interpersonal factors present. Students should also be able to understand articles and documents on familiar topics and write short texts, such as letters, descriptions and simple explanations.

Polish

Polish is offered to UTS students through an arrangement with Macquarie University. Students are placed in classes appropriate to their level of competence. The Polish language program allows students to improve their linguistic competence through practice in speaking and writing skills while consolidating their previous knowledge of grammar.

Russian

Russian is offered to UTS students through an arrangement with Macquarie University. Students are placed in classes appropriate to their level of competence. The aim of the Russian language program is to give students a good working knowledge of modern written and spoken Russian and to enable them to express themselves in the language correctly and with reasonable facility.

Slovenian

Slovenian is offered to UTS students through an arrangement with Macquarie University. Students are placed in classes appropriate to their level of competence. The aim of the Slovenian language program is to provide students with a sound knowledge of the language to enable them communicate effectively with particular emphasis placed on broadening their vocabulary and grammar.

Spanish Language and Culture

This language program is designed for students who are either complete beginners or who first learnt Spanish at school in Australia. There are two points of entry: the first for complete beginners and the second for students who have successfully completed HSC-level Spanish or its equivalent. Students take four units in the program, either units 1–4 (beginners) or 3–6 (post-HSC), determined by their point of entry.

Students with a language competence in Spanish that is higher than the program may be able to undertake further studies of Spanish at other universities in the Sydney area through arrangements made by the Institute.

The language program covers a broad range of communicative situations relevant to daily interaction in Spanish. The focus is on the development of speaking, listening, reading and writing skills appropriate to the situations that students are likely to encounter. Vocabulary and grammar are taught using written and audiovisual materials that cover a range of themes and situations.

Upon successful completion of the program, students would be expected to be able to communicate about familiar things, events and opinions, and to have developed skills and strategies for continuing their learning of the language in Spanish-speaking countries. Those students with prior knowledge of Spanish entering the program at a higher level would be expected to be able to communicate comfortably on a wide range of themes with the ability to adjust their language according to social variables such as formality, age and status. Each subject will be covered in one semester (13 weeks). There are six hours of language classes per week.

Spanish Language and Culture I

8cp; 1st semester, 6hpw; prerequisite: nil

Spanish 1 is the first in a series of four units designed to provide students who have no prior knowledge of the Spanish language with basic survival skills in language and culture, and the ability to undertake In-country Study in Latin America or Spain.

By the end of the subject, students would be expected to have achieved 'elementary proficiency' and be able to satisfy immediate communication needs using expressions and phrases they have learnt that are required in basic social interaction. The program allows for the development of listening,

speaking, reading and writing skills, and an understanding of the socio-cultural contexts in which the language is used. Students gain, in particular, an awareness of the background of Hispanic countries. Students also develop strategies for predicting the meaning of new expressions and anticipating ways of expressing new meanings.

Spanish 1 consists of 78 hours of classroom instruction. The approach adopted is 'communicative' and provides students with many opportunities to interact and use the language in various social and cultural contexts. Audiovisual equipment and computers will be used to facilitate learning.

Spanish Language and Culture 2

8cp; 2nd semester, 6hpw; prerequisite: Spanish Language and Culture 1

Spanish 2 is the second in a series of four units designed to provide students who have no prior knowledge of the Spanish language with basic survival skills in language and culture, and the ability to undertake In-country Study in Latin America or Spain.

By the end of the subject, students would be expected to have achieved 'minimum survival proficiency' in speaking, listening, reading and writing, and be able to satisfy immediate communication needs and minimum courtesy requirements in basic social interactions. Students will also develop an understanding of the socio-cultural contexts in which the language is used and further communication strategies.

Spanish 2 consists of 78 hours of classroom instruction. The approach adopted is 'communicative' and provides many opportunities for the students to interact and use the language in various social and cultural contexts. Audiovisual equipment and computers will be used to facilitate learning.

Spanish Language and Culture 3

8cp; 1st semester, 6hpw; prerequisite: Spanish Language and Culture 2 or HSC Spanish

Spanish 3 is the third in a series of four units for students with no prior knowledge of the Spanish language, or first in a series of four units for students who have successfully completed HSC-level Spanish or its equivalent. It provides students with basic survival skills in language and culture, and the ability to undertake In-country Study in Latin America or Spain.

By the end of the subject, students would be expected to have achieved a communicative competence in speaking, listening, reading and writing skills in order to be able to satisfy all 'survival' needs and limited social needs. They would also be expected to have developed an awareness of the various social and cultural contexts in which the language is used. In this subject, students develop the ability to understand the general content of magazine and newspaper articles.

Spanish 3 consists of 78 hours of classroom instruction. The approach adopted is 'communicative' and provides many opportunities for the students to interact and use the language in various social and cultural contexts. Audiovisual equipment and computers will be used to facilitate learning.

Spanish Language and Culture 4

8cp; 2nd semester, 6hpw; prerequisite: Spanish Language and Culture 3

Spanish 4 is the fourth in a series of four units for students with no prior knowledge of the Spanish language, or second in a series of four units for students who have successfully completed Spanish 3 and HSC-level Spanish or its equivalent. It provides students with basic survival skills in language and culture, and the ability to undertake In-country Study in Latin America or Spain.

By the end of the subject, students would be expected to have begun to develop the communication skills required to satisfy limited routine social and work demands. They would also be expected to have developed an awareness of the various social and cultural contexts in which the language is used. In this subject, students learn to express opinions, discuss education, entertainment and travel, and develop the language skills and background knowledge required to find accommodation.

Spanish 4 consist of 78 hours of classroom instruction. The approach adopted is 'communicative' and provides many opportunities for the students to interact and use the language in various social and cultural contexts. Audiovisual equipment and computers will be used to facilitate learning.

Spanish Language and Culture 5

8cp; 1st semester, 6hpw; prerequisite: Spanish Language and Culture 4

Spanish 5 is the third in a series of four units designed to provide students who have successfully completed Spanish 4 and HSC-level Spanish or its equivalent with the ability to consolidate and extend their knowledge during a period of In-country Study in Latin America or Spain.

By the end of the subject, students would be expected to have achieved communicative competence in speaking, listening, reading and writing, and to be able to satisfy routine social demands and limited work requirements. They would have developed an awareness of the various social and cultural contexts in which the language is used. Students learn to communicate in Spanish to compare lifestyles, university life and education, and practise interview techniques in preparation for In-country Study.

Spanish 5 consists of 78 hours of classroom instruction. The approach adopted is 'communicative' and provides many opportunities for the students to interact and use the language in various social and cultural contexts. There are discussions and debates on set topics. Audiovisual equipment and computers will be used to facilitate learning.

Spanish Language and Culture 6

8cp; 2nd semester, 6hpw; prerequisite: Spanish Language and Culture 5

Spanish 6 is the fourth in a series of four units designed to provide students who have successfully completed Spanish 5 and HSC-level Spanish or its equivalent with the ability to consolidate and extend their knowledge during a period of In-country Study in Latin America or Spain.

By the end of the subject, students would be expected to be able to speak the language with sufficient accuracy, and to participate in limited formal and informal conversations on practical and social topics. Students would also be expected to be able to read and write with sufficient accuracy to meet a limited range of social and work needs. Language focuses on topics such as the economy, class and social stratification, gender roles, religion and beliefs, literature, and the arts.

Spanish 6 consists of 78 hours of classroom instruction. The approach adopted is 'communicative' and provides many

opportunities for the students to interact and use the language in various social and cultural contexts. There are discussions and debates on set topics. Audiovisual equipment and computers will be used to facilitate learning.

Thai

Thai is offered to UTS students through the language program offered jointly by the University of Sydney and Macquarie University. The program is designed to allow complete beginners in Thai to reach a survival level that will allow them to continue their studies in Thailand. If student numbers permit, classes will be available on UTS campuses.

Ukrainian

Ukrainian is offered to UTS students through an arrangement with Macquarie University. Combined degree students with a sound working knowledge of the language are admitted to study Ukrainian. Students are placed in classes appropriate to their level of competence. The Ukrainian language program allows students to improve their reading, writing and oral skills with particular emphasis placed on the study of grammar and syntax.

Alphabetical list of subjects

Asian and Pacific Politics	52300	In-country Study 1: China, ZheDa	977111
Cantonese Language and Culture 1	971121	In-country Study 1: Croatia	977740
Cantonese Language and Culture 2	972121	In-country Study 1: Croatia, Zagreb	977741
Cantonese Language and Culture 3	973121	In-country Study 1: France	977410
Cantonese Language and Culture 4	974121	In-country Study 1: France, Lyon 2	977411
Chinese East Asia	976101	In-country Study 1: France, Reims	977412
Chinese Language and Culture 1	971111	In-country Study 1: France, Rennes	977413
Chinese Language and Culture 2	972111	In-country Study 1: France, Toulon	977414
Chinese Language and Culture 3	973111	In-country Study 1: Germany	977420
Chinese Language and Culture 4	974111	In-country Study 1: Germany, Duisburg	977422
Colonialism and Post-Colonialism	52321	In-country Study 1: Germany, HWP Hamburg	97423
Comparative Religions	52302	In-country Study 1: Germany, Saarbrücken	977421
Contemporary China	976111	In-country Study 1: Greece	977710
Contemporary Cultures 1	50228	In-country Study 1: Guangdong or Hong Kong	97712x
Contemporary Cultures 2	50229	In-country Study 1: Indonesia	977310
Contemporary Europe	976401	In-country Study 1: Indonesia, Universiti Gadjah Mada	977311
Contemporary Japan	976211	In-country Study 1: Italy	977430
Contemporary Latin America	976501	In-country Study 1: Italy, Bologna	977431
Contemporary South-East Asia	976301	In-country Study 1: Italy, Florence	977433
Croatian 1	971744	In-country Study 1: Italy, Siena	977432
Croatian 2	972744	In-country Study 1: Japan	977210
Croatian 3	97374	In-country Study 1: Japan, Akita	977214
Croatian 4	974744	In-country Study 1: Japan, Hokkaido, Hakodate	977215
French Language and Culture 1	971414/5	In-country Study 1: Japan, Kyoto	977216
French Language and Culture 2	972414/5	In-country Study 1: Japan, Kyushu Institute of Technology	977213
French Language and Culture 3	973414/5	In-country Study 1: Japan, Senshu	977211
French Language and Culture 4	974414/5	In-country Study 1: Japan, Yamanashi	977217
Gender, Culture and Power	52306	In-country Study 1: Japan, Yokohama	977218
German Language and Culture 1	971424/5	In-country Study 1: Malaysia	977330
German Language and Culture 2	972424/5	In-country Study 1: Malaysia, Universiti Sains Malaysia	977331
German Language and Culture 3	973424/5	In-country Study 1: Malaysia, Sarawak	977332
German Language and Culture 4	974424/5	In-country Study 1: Mexico	977530
Greek 1	971710	In-country Study 1: Mexico, ITESM, Monterrey	977531
Greek 2	972710	In-country Study 1: Poland	977760
Greek 3	973710	In-country Study 1: Poland, Warsaw	977761
Greek 4	974710	In-country Study 1: Russia	977730
Hebrew 1	971625	In-country Study 1: Slovenia	977750
Hebrew 2	972625	In-country Study 1: South China	977120
Hebrew 3	973625	In-country Study 1: South China, HKUST	977121
Hebrew 4	974625	In-country Study 1: South China, Zhongshan Daxue, Canton	977122
Hindi 1	971615	In-country Study 1: Spain	977450
Hindi 2	972615	In-country Study 1: Spain, Barcelona	977451
Hindi 3	973615	In-country Study 1: Spain, Salamanca	977xxx
Hindi 4	974615		
In-country Study 1: Argentina	977510		
In-country Study 1: Argentina, Cordoba	977514		
In-country Study 1: Argentina, San Luis	977515		
In-country Study 1: Chile	977520		
In-country Study 1: Chile, Concepción	977523		
In-country Study 1: Chile, Universidad Católica de Chile	977522		
In-country Study 1: China	977110		

In-country Study 1: Spain, University of Malaga	977452	In-country Study 2: Malaysia, Sarawak	978332
In-country Study 1: Taiwan	977130	In-country Study 2: Mexico	978530
In-country Study 1: Taiwan, National Chengchi University, Taipei	977132	In-country Study 2: Mexico, ITESM	978531
In-country Study 1: Taiwan, TaiDa	977131	In-country Study 2: Poland	978760
In-country Study 1: Thailand	977320	In-country Study 2: Poland, Warsaw	978761
In-country Study 1: Thailand, Khon Kaen University	977322	In-country Study 2: Russia	978730
In-country Study 1: Ukraine	977770	In-country Study 2: Slovenia	978750
In-country Study 1: Uruguay	977550	In-country Study 2: South China	978120
In-country Study 2: Argentina	978510	In-country Study 2: South China, HKUST	978121
In-country Study 2: Argentina, Cordoba	978514	In-country Study 2: South China, Zhongshan Daxue, Canton	978122
In-country Study 2: Argentina, San Luis	978515	In-country Study 2: Spain	978450
In-country Study 2: Chile	978520	In-country Study 2: Spain, Barcelona	978451
In-country Study 2: Chile, Concepción	978523	In-country Study 2: Spain, Salamanca	978xxx
In-country Study 2: Chile, Universidad Católica de Chile	978522	In-country Study 2: Spain, University of Malaga	978452
In-country Study 2: China	978110	In-country Study 2: Taiwan	978130
In-country Study 2: China, ZheDa	978111	In-country Study 2: Taiwan, National Chengchi University, Taipei	978132
In-country Study 2: Croatia	978740	In-country Study 2: Taiwan, TaiDa	978131
In-country Study 2: Croatia, Zagreb	978741	In-country Study 2: Thailand	978320
In-country Study 2: France	978410	In-country Study 2: Thailand, Khon Kaen University	978322
In-country Study 2: France, Lyon 2	978411	In-country Study 2: Ukraine	978770
In-country Study 2: France, Reims	978412	In-country Study 2: Uruguay	978550
In-country Study 2: France, Rennes	978713	Indonesian Language and Culture 1	971311
In-country Study 2: France, Toulon	978414	Indonesian Language and Culture 2	972311
In-country Study 2: Germany	978420	Indonesian Language and Culture 3	973311
In-country Study 2: Germany, Duisburg	978422	Indonesian Language and Culture 4	974311
In-country Study 2: Germany, HWP Hamburg	978423	International Legal Studies	77600
In-country Study 2: Germany, Saarbrücken	978421	International Politics	52222
In-country Study 2: Greece	978710	Italian Language and Culture 1	971434/5
In-country Study 2: Guangdong or Hong Kong	97712x	Italian Language and Culture 2	972434/5
In-country Study 2: Indonesia	978310	Italian Language and Culture 3	973434/5
In-country Study 2: Indonesia, Universiti Gadjah Mada	978311	Italian Language and Culture 4	974434/5
In-country Study 2: Italy	978430	Japanese Language and Culture 1	971211
In-country Study 2: Italy, Bologna	978431	Japanese Language and Culture 2	972211
In-country Study 2: Italy, Florence	978433	Japanese Language and Culture 3	973211
In-country Study 2: Italy, Siena	978432	Japanese Language and Culture 4	974211
In-country Study 2: Japan	978210	Korean 1	971225
In-country Study 2: Japan, Akita	978214	Korean 2	972225
In-country Study 2: Japan, Hokkaido, Hakodate	978215	Korean 3	973225
In-country Study 2: Japan, Kyoto	978216	Korean 4	974225
In-country Study 2: Japan, Kyushu Institute of Technology	978213	Latin 1	971445
In-country Study 2: Japan, Senshu	978211	Latin 2	972445
In-country Study 2: Japan, Yamanashi	978217	Latin 3	973445
In-country Study 2: Japan, Yokohama	978218	Latin 4	974445
In-country Study 2: Malaysia	978330	Malaysian Language and Culture 1	971331
In-country Study 2: Malaysia, Universiti Sains Malaysia	978331	Malaysian Language and Culture 2	972331
		Malaysian Language and Culture 3	973331
		Malaysian Language and Culture 4	974331
		Modernisation and Social Change (Undergraduate)	50140
		Modernisation and Social Change (Postgraduate)	50175
		Colonialism and Modernity	50231

140 ALPHABETICAL LIST OF SUBJECTS

Polish 1	971764	Spanish Language and Culture 1	971501
Polish 2	972764	Spanish Language and Culture 2	972501
Polish 3	973764	Spanish Language and Culture 3	973501
Polish 4	974764	Spanish Language and Culture 4	974501
Power and Change in Australia	50230	Thai 1	971320
Power, Race and Ethnicity	52316	Thai 2	972320
Russian 1	971734	Thai 3	973320
Russian 2	972734	Thai 4	974320
Russian 3	973734	Ukrainian 1	971774
Russian 4	974734	Ukrainian 2	972774
Slovenian 1	971754	Ukrainian 3	973774
Slovenian 2	972754	Ukrainian 4	974774
Slovenian 3	973754		
Slovenian 4	974754		

Board of Studies

Member representation

To be advised

Chair, a Deputy Chair, Academic Board

Professor D S G Goodman

Director, Institute for International Studies

Ms L Shoemark

Deputy Director, Institute for International Studies

Mr G Ta

Associate Director, Institute for International Studies

Ms S Meiras-Colley

Academic Administrator, Institute for International Studies

Ms S Xouris

Language Coordinator, Institute for International Studies

Dr M Heller

Lecturer, Latin American Studies, Institute for International Studies

Mr C Mula

Administrative Assistant, Institute for International Studies

Ms Ilze Frank

Director, International Programs

Associate Professor G W Ticehurst

Faculty of Business

Dr C Langston

Faculty of Design, Architecture and Building

Mr R Forman

Faculty of Education

Mr P Maloney

Faculty of Engineering

Professor A Jakubowicz

Faculty of Humanities and Social Sciences

Dr D Meltz

Faculty of Law

Associate Professor J Edwards

Faculty of Mathematical and Computing Sciences

Dr J Crisp

Faculty of Nursing

Dr A Ray

Faculty of Science

Ms M Huyskens

Student representative, Bachelor of Tourism Management/Bachelor of Arts in International Studies

Mr S Farmer

Student representative, Bachelor of Laws/Bachelor of Arts in International Studies

Mr P Porter

Director, Insearch Language Centre

Staff list

Professor of International Studies and Director
D S G Goodman, BA (Manc), DipEcon
(Beijing), PhD (Lond)

Deputy Director
L Shoemark, BA (Hons), DipEd, DipLabRlns
and Law (Syd)

Associate Directors
R Brill, BEd (KCAE), MEd (Syd)
G Ta, BA (Sing), MEd (Syd)

In-country Studies Coordinator
S King, BA DipEd (UNSW), DipTESOL
(SCAE) MA (Syd)

Office Administrator
M Gavran

Academic Administrator
S Meiras-Colley, BSc (Syd)

Lecturer in China Studies
C Feng, BA (Zhongshan), PhD (Nankai)

Lecturer in Japanese Studies
K Morita, BA, MA (Japan), PhD (Hull)

Lecturer in Latin American Studies
M Heller, BA (Hons) (Portsmouth), MPhil,
PhD (Sussex)

Lecturer in Southeast Asian Studies
B Leigh, BA (Hons), PhD (Syd)

Lecturer in Spanish Studies
I Perez-Molina, BA, PhD (Barcelona)

Research Officer
Y Wang, BA (Sichuan), MA (Adel)

Executive Assistant
W Robjohns, BA (UNSW)

Administrator – Student Matters
C Mula, BA, DipEd (Macq)

Administrative Assistant
M Marco, BA (ACU)

Administrative Assistant, Projects
P Wong

*Director, Language Programs (Insearch
Language Centre)*
P Carpenter, BA, DipEd (Syd)

*Coordinator Language & Culture Programs
(Insearch Language Centre)*
S Xouris, BA, DipEd (Syd)

*Senior Chinese Language Teacher (Insearch
Language Centre)*

X Zhang, BA (Huazhong Normal), GradDip
(Hunan Normal), MA (UNSW)

*Senior Japanese Language Teacher (Insearch
Language Centre)*

K Matsumoto, BA (Aoyama Gakuin), TESOL
(Japan)

*Senior Indonesian and Malaysian Language
Teacher (Insearch Language Centre)*

S Bahrum, BA (Syd), GradCertTESOL
(CSturt)

*Spanish Language Teacher (Insearch Language
Centre)*

J Matto, BA (Uruguay)

Index

A

Academic support and pastoral care 21
 Addresses and telephone numbers 6
 Admission 19
 Alphabetical list of subjects 138
 Alternative arrangements 22
 Applying for UTS courses 11
 Arabic 125
 Argentina major 23
 Asian and Pacific Politics 67
 Australia and the Asia-Pacific
 Region major 25
 Australia in the World 27
 Australian English Language and
 Culture 1 26
 Australian English Language and
 Culture 2 26
 Austudy, eligibility 16

B

Bachelor of Applied Science in Information
 Studies/Bachelor of Arts in
 International Studies 94
 Bachelor of Arts in Communication
 (Journalism) and in
 International Studies 98
 Bachelor of Arts in Communication
 (Media Arts and Production) and in
 International Studies 99
 Bachelor of Arts in Communication (Public
 Communication) and in International
 Studies 101
 Bachelor of Arts in Communication (Writing
 and Contemporary Cultures) and in
 International Studies 103
 Bachelor of Arts in Human Movement
 Studies and in International Studies 73
 Bachelor of Arts in Leisure Management
 and in International Studies 75
 Bachelor of Arts in Social Science and in
 International Studies 96
 Bachelor of Arts in Tourism Management
 and in International Studies 76
 Bachelor of Building in Construction
 Economics/Bachelor of Arts in
 International Studies 78
 Bachelor of Building in Construction
 Management/Bachelor of Arts in
 International Studies 80
 Bachelor of Business/Bachelor of Arts in
 International Studies 72
 Bachelor of Design in Fashion and Textile
 Design/Bachelor of Arts in
 International Studies 81

Bachelor of Design in Industrial Design/
 Bachelor of Arts in International
 Studies 85
 Bachelor of Design in Interior Design/
 Bachelor of Arts in International
 Studies 83
 Bachelor of Design in Visual
 Communication/Bachelor of Arts in
 International Studies 86
 Bachelor of Education/Bachelor of Arts in
 International Studies 90
 Bachelor of Engineering, Diploma in
 Engineering Practice/Bachelor of Arts
 in International Studies 92
 Bachelor of Health Science in Acupuncture/
 Bachelor of Arts in International
 Studies 114
 Bachelor of Land Economics/Bachelor of
 Arts in International Studies 88
 Bachelor of Laws/Bachelor of Arts in
 International Studies 104
 Bachelor of Mathematics and Finance/
 Bachelor of Arts in International
 Studies 110
 Bachelor of Nursing/Bachelor of Arts in
 International Studies 112
 Bachelor of Science in Computing Science/
 Bachelor of Arts in International
 Studies 106
 Bachelor of Science in Mathematics/Bachelor
 of Arts in International Studies 108
 Bachelor of Science/Bachelor of Arts in
 International Studies 116
 Board of Studies 141

C

Campus Maps 7
 Cantonese Language and Culture 55, 125
 Chile major 28
 China major 30
 Chinese East Asia 55, 63, 68
 Chinese Language and Culture 30, 62, 127
 Colonialism and Post-Colonialism 68
 Communication for Employment 26
 Comparative Religions 68
 Contemporary Australia 27
 Contemporary China 31, 68
 Contemporary Cultures 1 68
 Contemporary Cultures 2 69
 Contemporary Europe
 32, 33, 35, 37, 40, 51, 52, 53, 60, 66, 69
 Contemporary Japan 43, 69
 Contemporary Latin America
 24, 29, 45, 49, 69
 Contemporary Society 18

Contemporary South-East Asia
39, 47, 58, 64, 69

Costs 22

Courses, Postgraduate 119

Courses, Undergraduate 71

Credit points and workload 124

Croatia major 31

Croatian 32, 129

E

Electives and non-award studies 16

Enrolment procedures for language
subjects 124

Essay Writing 26

F

France major 33

French Language and Culture 33, 129

G

Gender, Culture and Power 69

German Language and Culture 35, 129

Germany major 35

Graduate Diploma in International
Studies 120

Greece major 37

Greek 37, 129

H

Hebrew 129

Hindi 129

I

In-country Study 19

In-country Study 1: Argentina 24

In-country Study 1: Chile 29

In-country Study 1: Chile or Mexico 45

In-country Study 1: China 31

In-country Study 1: Croatia 32

In-country Study 1: France 33

In-country Study 1: Germany 35

In-country Study 1: Greece 37

In-country Study 1: Guangdong or
Hong Kong 56

In-country Study 1: Indonesia 39, 58

In-country Study 1: Italy 40

In-country Study 1: Japan 43

In-country Study 1: Malaysia 47

In-country Study 1: Mexico 49

In-country Study 1: Poland 51

In-country Study 1: Russia 52

In-country Study 1: Slovenia 54

In-country Study 1: Spain 60

In-country Study 1: Taiwan 63

In-country Study 1: Thailand 64

In-country Study 1: Ukraine 66

In-country Study 2: Argentina 24

In-country Study 2: Argentina or Chile 45

In-country Study 2: Chile 29

In-country Study 2: China 31

In-country Study 2: Croatia 32

In-country Study 2: France 33

In-country Study 2: Germany 36

In-country Study 2: Greece 37

In-country Study 2: Guangdong or
Hong Kong 56

In-country Study 2: Indonesia 39

In-country Study 2: Italy 40

In-country Study 2: Japan 43

In-country Study 2: Malaysia 47, 58

In-country Study 2: Mexico 49

In-country Study 2: Poland 51

In-country Study 2: Russia 52

In-country Study 2: Slovenia 54

In-country Study 2: Spain 60

In-country Study 2: Taiwan 63

In-country Study 2: Thailand 64

In-country Study 2: Ukraine 66

In-country Study for Engineering
students 22

Indonesia major 38

Indonesian Language and
Culture 38, 57, 129

Information

Centres 11

Institute 14

Student 14

Institute for International Studies 14

Institute information 14

Institute Mission Statement 14

International Legal Studies 70

International Politics 70

International studies for international
students (ISIS program) 117

International Studies program 17

Italian Language and Culture 40, 131

Italy major 40

J

Japan major 42

Japanese Language and Culture 42, 131

K

Korean 132

L

Language and Culture 18

Language programs 125

Language studies 124

Latin 132

Latin America major 44

List of approved substitute subjects 67

M

- Majors
 - Argentina 23
 - Australia and the Asia-Pacific Region 25
 - Chile 28
 - China 30
 - Croatia 31
 - France 33
 - Germany 35
 - Greece 37
 - Indonesia 38
 - Italy 40
 - Japan 42
 - Latin America 44
 - Malaysia 46
 - Mexico 48
 - Poland 50
 - Russia 52
 - Slovenia 53
 - South China 54
 - South-East Asia 57
 - Spain 59
 - Taiwan 61
 - Thailand 64
 - Ukraine 65
- Majors in the International Studies program 23
- Making Australia 27
- Malaysia major 46
- Malaysian Language and Culture 46, 57, 133
- Master of Arts in International Studies 122
- Mexico major 48
- Modernisation and Social Change (see entry for all majors) 18
- Modernity and Colonialism 70

N

- Non-award studies 16

P

- Partner universities hosting In-country Study programs 21
- Poland major 50
- Polish 50, 135
- Postgraduate courses 119
- Postgraduate Coursework Degree Program in International Studies 119
- Postgraduate studies 16
- Power and Change in Australia 70
- Power, Race and Ethnicity 70
- Principle dates for 1998 12
- Prerequisites 20
- Programs, Language 125

R

- Report Writing 26
- Research degrees 119
- Russia major 52
- Russian 52, 135

S

- Seminar Presentation 26
- Slovenia major 53
- Slovenian 53, 135
- South China major 54
- South-East Asia major 57
- Spain major 59
- Spanish 136
- Spanish Language and Culture 23, 28, 44, 48, 60, 135
- Special arrangements 67
- Staff list 142
- Student information 14
- Subjects, Alphabetical list of 138
- Subjects, List of approved substitute 67

T

- Taiwan major 61
- Thai 64, 137
- Thailand major 64

U

- Ukraine major 65
- Ukrainian 65, 137
- Undergraduate combined degree program 15
- Undergraduate courses 71

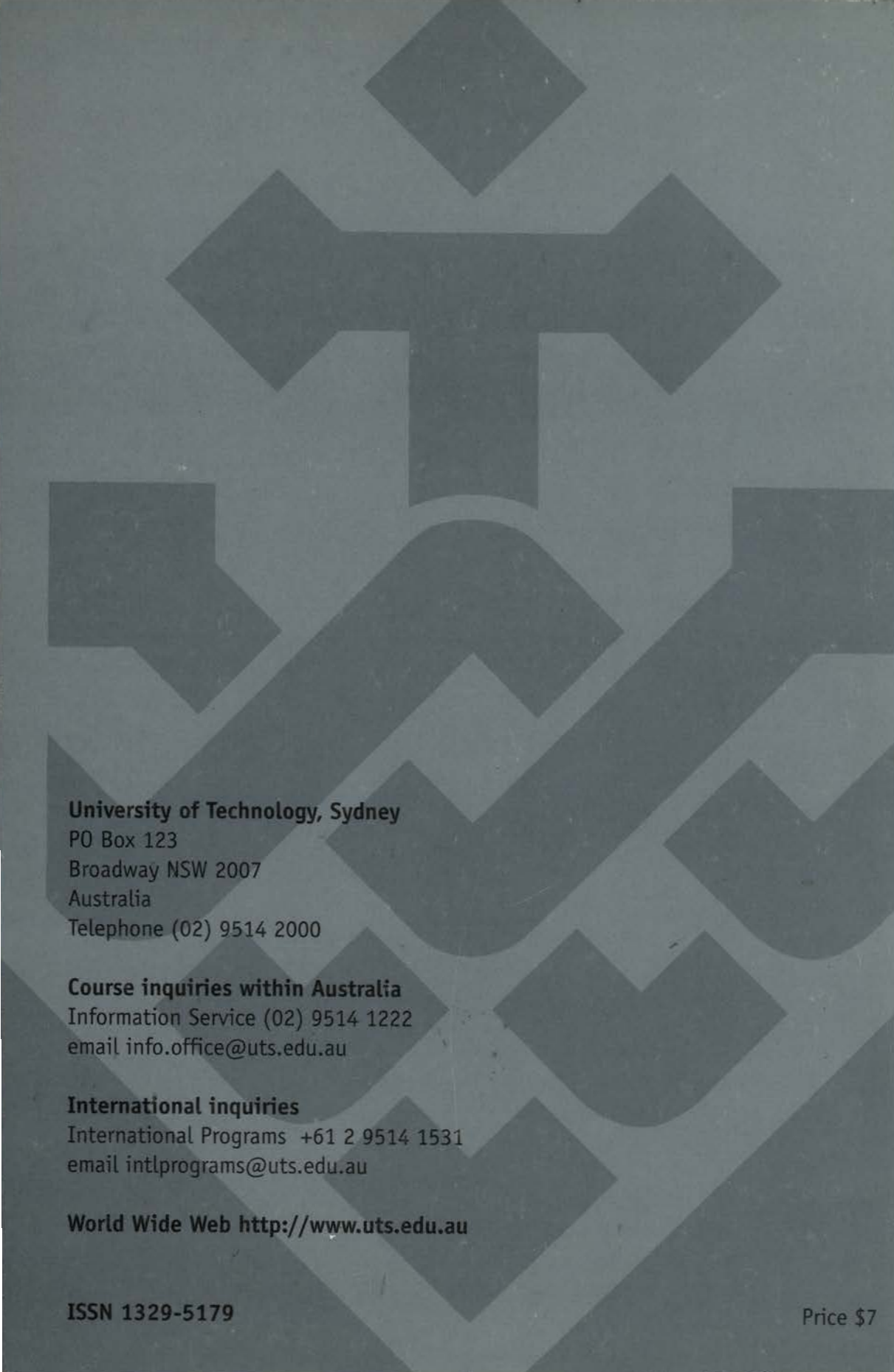

University of Technology, Sydney

PO Box 123

Broadway NSW 2007

Australia

Telephone (02) 9514 2000

Course inquiries within Australia

Information Service (02) 9514 1222

email info.office@uts.edu.au

International inquiries

International Programs +61 2 9514 1531

email intlprograms@uts.edu.au

World Wide Web <http://www.uts.edu.au>

ISSN 1329-5179

Price \$7